



“Why do we have such passion about perfecting products that are utilitarian in nature?

Because the everyday heroes who use them inspire us.”

This is a proud moment for us. One that builds upon a strong heritage with a re-energized commitment to an exciting future. The following pages are the result of five years of research, analysis, deliberation, debate and hard work. Welcome to PolyScience, the Next Chapter.

This catalog, along with a newly designed website, expresses a significant evolution in our history and speaks with a united voice about the innovation, passion and user focus we bring to every piece of our temperature-control equipment. It not only premieres a new breakthrough series of circulators, but also reveals a rethinking of our other offerings, bringing them in line with our vision for tomorrow. We believe that even the hardest working tools should be easy to use and easy on the eyes.

No vision of tomorrow can be complete without considering the environment. As a global company, we realize everything we do has far-reaching impact. That is why our products are in accordance with RoHS guidelines to eliminate harmful substances like lead and cadmium. Through a consistent effort we've decreased energy consumption by over 22% over the last two years alone, even though production has increased over thirty percent. Our products are designed to be energy efficient and environmentally-friendly as well. We gladly offer equipment recycling.

Please enjoy the catalog, thank you for your interest in PolyScience, and thank you for your inspiration in making temperature-control equipment a little bit...cooler.

–Philip Preston, President



RoHS



GREEN  
INITIATIVES





Contents:

## 8-67 CIRCULATING BATHS

- 12-29 Temperature Controllers
- 28-29 Selection Guide
- 30-45 Refrigerated Circulating Baths
- 32-33 Selection Guide
- 34-35 Performance Programmable
- 36-37 Advanced Programmable
- 38-39 Performance Digital
- 40-41 Advanced Digital
- 42-43 Standard Digital
- 44-45 MX
- 46-61 Heated Circulating Baths
- 48-49 Selection Guide
- 50-51 Performance Programmable
- 52-53 Advanced Programmable
- 54-55 Performance Digital
- 56-57 Advanced Digital
- 58-59 Standard Digital
- 60-61 MX
- 62-63 Stainless Steel Open Bath Systems
- 64-65 Polycarbonate Open Bath Systems
- 66 MX Immersion Circulator
- 67 Open Tanks
- 67 Stainless Steel
- 67 Polycarbonate
- 67 Model 210 Heated Recirculator

## 68-83 SPECIALTY PRODUCTS

- 70-71 Viscosity Baths
- 72-73 Calibration Baths
- 74 75 Liter Refrigerated Circulating Bath
- 75 Cryoprecipitate Bath
- 75 Refrigerated Open Bath
- 76 Histology Bath and Histology Freeze Plate
- 77 Coliform Bath
- 78-83 Refrigerated and Heated Circulator and Specialty Product Accessories

## 84-91 GENERAL PURPOSE WATER BATHS

- 86-87 Digital
- 88-89 Economy
- 90-91 General Purpose Water Bath Accessories

## 92-115 CHILLERS & COOLERS

- 96-106 Chillers
- 96 Selection Guide: Benchtop and 6000 Series
- 97 Selection Guide: DuraChill™ & Non-Refrigerated Coolers
- 98-101 Benchtop Chillers
- 98-99 LS Series
- 100 LM Series
- 101 MM Series
- 102-106 Portable Chillers
- 102-103 6000 Series
- 104-106 DuraChill™
- 107-108 Recirculating Coolers
- 107 Model 3370 Liquid-to-Air Cooler
- 108 Model 4100 Liquid-to-Liquid Cooler
- 109 Factory Installed Chiller Options
- 110-112 Chiller Fluids and Accessories
- 113-115 Low Temperature Coolers
- 114 Immersion Probe
- 115 Flow-through

## 116-155 TECHNICAL INFORMATION

- 116-119 Glossary
- 120 Choosing A PolyScience Product
- 121 Application Reference Guide
- 122-123 Selecting A Circulating Bath
- 124-125 How To Select A Chiller
- 126 Chiller Cooling Curves
- 127 DuraChill™ Factory Installed Options
- 128 Product Part Numbers and Electrical Plug Options
- 129 Getting the Most from Your PolyScience Circulating Bath or Chiller
- 129 Regulatory Testing and Compliance
- 130-153 Technical Specifications
- 154-155 Customer Service and Support



## Driven.

Once a pioneer, always a pioneer.

Like many global companies, we started out small but kept thinking big.

Since 1963, we've responded to the needs of laboratory, plastics, culinary, medical, chemical and industrial markets with innovations ranging from the first zero-switching circulators to the first refrigeration systems for DNA amplification to an award-winning line of culinary products. Fueled by a tenacious spirit and the satisfaction that comes only from real breakthroughs, our forward thinking has kept us ahead of the curve.

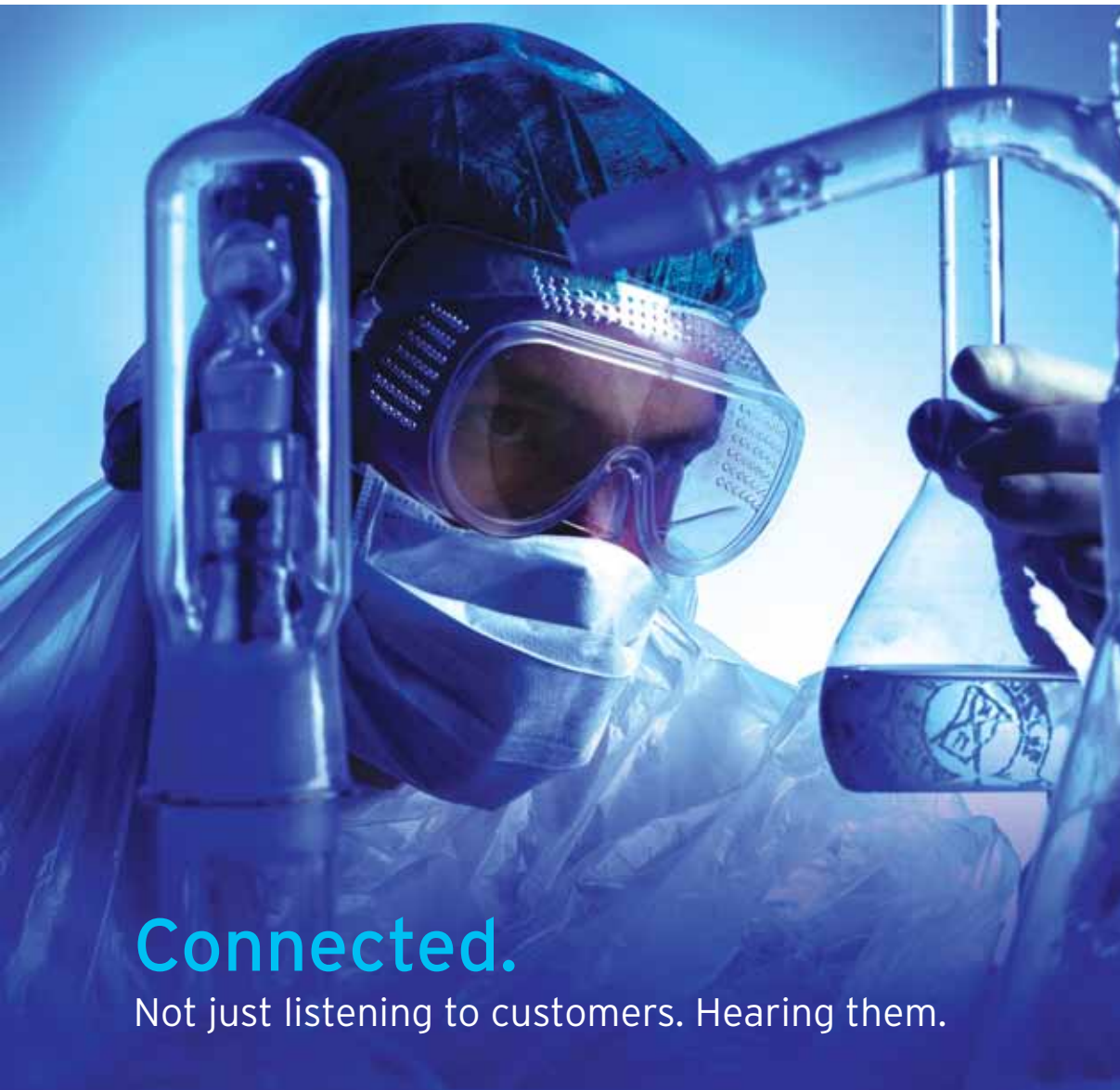

## Connected.

Not just listening to customers. Hearing them.



Even the best engineers can't operate in isolation.

That's why our engineers and sales team spend countless hours gathering firsthand input from technicians in laboratories and industrial settings and many more hours observing work environments to understand how we can build products that integrate more seamlessly. Simplify tasks. Take less space. Better accommodate worker logistics. And even look better. Our longstanding relationships with our customers generate real insights into what's necessary to help them be more productive and happy. The result? There's no need for the people who use our products to understand PolyScience equipment. Our equipment understands them.

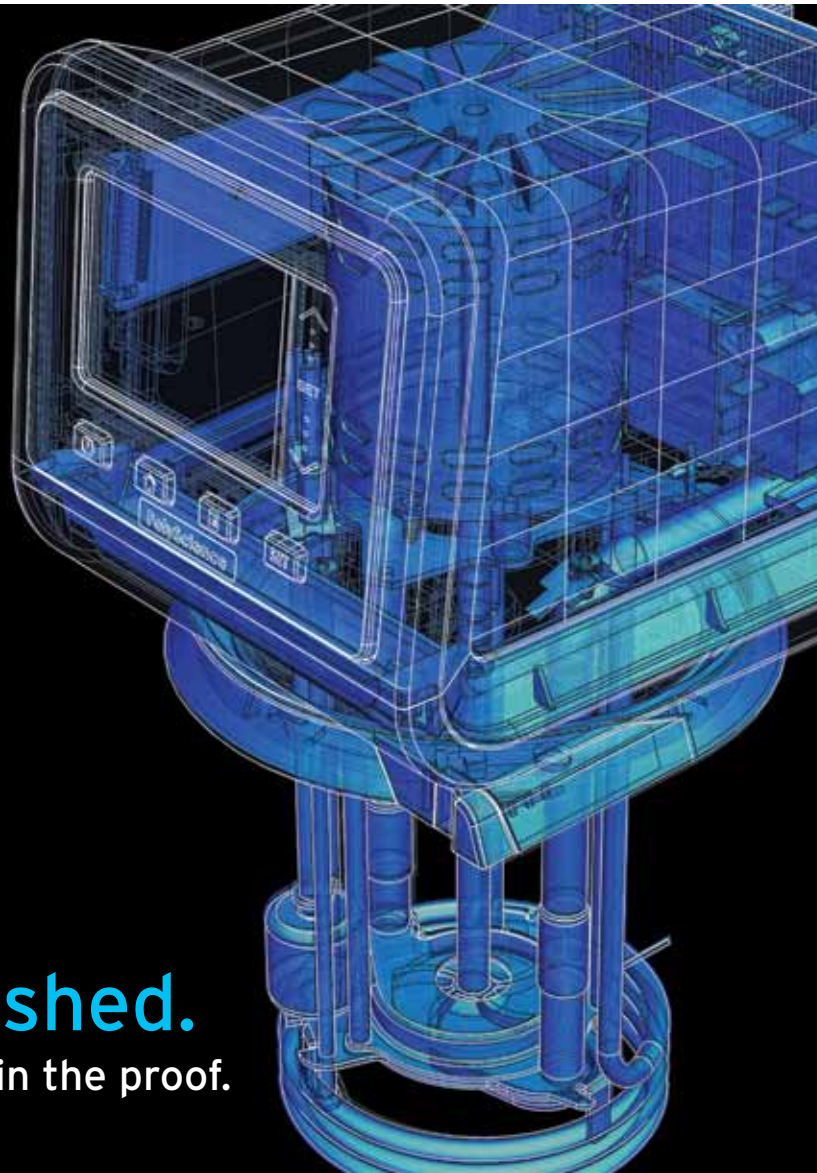

**Established.**  
The proof is in the proof.

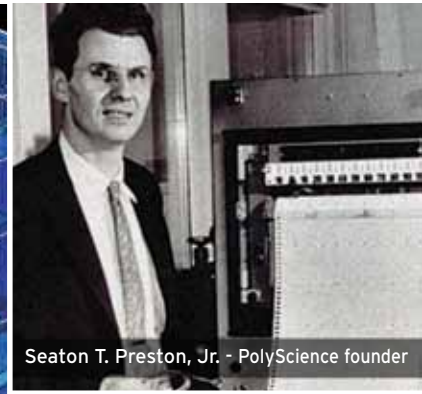

Seaton T. Preston, Jr. - PolyScience founder



1973 vintage Immersion Circulator



1964 - Our first building

Back in 1963, we were a start-up.

We didn't have the luxury of thousands of uninterrupted operating hours on our equipment in the field to back up our story. Thankfully, customers gave us a chance. Since then, we have sold over one million temperature control solutions both under our brand name and as private label for large, well-respected manufacturers and distributors. Our dedication to quality, ease-of-operation and reliability has helped us become a global company that spans six continents and most major cities around the world. All our products – refrigerated circulators, heated circulators, chillers, recirculating coolers, water baths and custom equipment – are researched and designed by our own highly trained engineering staff and submitted to rigorous Quality Assurance testing.

Our ISO 9001 quality management system and manufacturing process combines the high quality and detail of hand craftsmanship with the precision and efficiency of ultramodern production and testing processes. After over five decades, we're no longer a start-up. But we value your trust in us just as we did back in 1963.



## Accommodating.

Responding to OEM needs. NOW.

Versatility and flexibility make us the perfect partners.

From viscometers to computed tomography scanners, lasers to bioreactors, our temperature control equipment is the perfect addition to Original Equipment Manufacturers' (OEM) equipment. Our extensive history with OEM engineers has allowed us to immerse ourselves in their many challenges. We are committed to finding solutions that help OEMs get to market faster and within budget. Often, this means modifying a stock circulator, chiller or low-temperature cooler to better suit a particular objective. Our engineering team works closely with OEMs to make both minor tweaks and major changes quickly and cost effectively. We can even do a complete ground up design and build. Our agility and collaborative spirit help OEMs build better machines and satisfied customers, faster.

# PolyScience Circulating Baths

One of the best lab partners you'll ever have.

Precise. Reliable. With sleek lines and exceptionally large digital displays, our Circulating Baths are easy on the eyes. But even the most attractive lab partner needs to get down to business. So, we've made our Circulating Baths exceptionally hard-working, easy to operate and maintain. PolyScience equipment is the lab partner that makes your life easier and more productive.

- Reservoir sizes ranging from 6 liters to 75 liters
- Heated-only and Refrigerated/Heated models (90+ models, including an Immersion Circulator)
- Six types of digital temperature controllers offer a range of selection from entry-level to ultra sophisticated
- Intuitive setup and operation, featuring either multi-language help or screen prompts (depending on the model)



12-29	Temperature Controllers	46-61	Heated Circulating Baths	62-63	Stainless Steel Open Bath Systems
28-29	Selection Guide	48-49	Selection Guide	64-65	Polycarbonate Open Bath Systems
30-45	Refrigerated Circulating Baths	50-51	Performance Programmable	66	MX Immersion Circulator
32-33	Selection Guide	52-53	Advanced Programmable	67	Open Tanks
34-35	Performance Programmable	54-55	Performance Digital	67	Stainless Steel
36-37	Advanced Programmable	56-57	Advanced Digital	67	Polycarbonate
38-39	Performance Digital	58-59	Standard Digital	67	Model 210 Heated Recirculator
40-41	Advanced Digital	60-61	MX		
42-43	Standard Digital				
44-45	MX				







## Features:

- **Swivel 180™**

Need to position your bath at an odd angle or read the temperature from across the room? We've got it covered. The patent-pending Swivel 180™ Rotating Controller on PolyScience Circulating Baths lets you move the extra large temperature display independently from the bath, enabling you to clearly read the display from anywhere within a 180° viewing radius, with the press of a button.

- **Highly intuitive user interface**

User-friendly temperature controllers guide you through setup and operation using universal icons, on-screen help, and logical menus.

- **LidDock™**

Our lid stowing system gives the lid a convenient place to perch while you add liquid or work with samples, yet doesn't interfere with controller viewing or operation. Condensation drains back into the reservoir as well, keeping your lab bench clean, dry and uncluttered.

- **DuraTop™**

The precision-molded phenolic bath top remains cooler at high temperatures and resists laboratory chemicals. Plus, it's easily cleaned and disinfected.

- **WhisperCool™**

Quiet, energy-efficient heat removal. Our patent-pending WhisperCool™ Environmental Control System, standard on most PolyScience Refrigerated/Heated Circulating Baths, reduces noise levels below conversational speech at a distance of two meters. In addition, our adaptive environmental technology optimizes performance, reducing overall energy consumption and prolonging equipment life.

- **Cool Command™ technology**

Achieve the temperature you want, when you want it. Cool Command™ efficiently and quickly extracts heat, even at elevated bath temperatures, ensuring the most precise temperature control.



- **Large bath opening**

Access has been increased to allow for maximum utilization of the circulating bath.

- **Class III safety**

Our Performance and Advanced Series Controllers feature temperature and float shut-off systems meeting DIN 12876-1 Class III standards for use with flammable liquids.

- **Pressure and suction pump**

Powerful, variable-speed pumps are available on Performance and Advanced Series Temperature Controllers and are well suited to open- or closed-loop external applications.

- **Simplified setup and maintenance**

The front-mounted drain makes it easy to remove liquid from the bath and clean it. Our washable air filter helps you keep the circulator running at peak performance and energy efficient. DuraTop™, and all surfaces, are chemical resistant and easy to sanitize. Setup instructions are printed “behind the grille.”

- **Ergonomic design**

You can easily reposition the circulating bath with convenient, built-in handles that don't catch other equipment.

- **Safe and reliable**

The elimination of RoHS-specified chemical substances from fabricated components contributes to a cleaner, safer environment. In addition, all of our baths comply with WEEE, IEC 61010-1, IEC 61010-2-010, IEC 61326-1, DIN 12876 and are CE and ETL certified.

- **Easy hook-up fluid connections**

1/4" NPT fittings with hose adapters included for 3/8", 1/4" and 3/16"; 1/4" NPT to M16 adapter also included with 50 Hz models.

# PolyScience Temperature Controllers: Redefining Cool

## Features:

- Intuitive, icon-driven operation
- Complete operating information displayed on a single screen
- Large, easy to read displays
- Multiple connectivity options
- Temperature stability as precise as  $\pm 0.005^{\circ}\text{C}$
- Customizable features and functions, for the way you work



Our new series of PolyScience controllers is revolutionary. From the sleek contemporary profile to the ultra-intuitive interface, we have created a new and better breed of temperature controllers. Easy to use, informative, eye catching and connected, we have designed a stable, reliable, and precise partner for your lab bench.



## Features:

- Intuitive touch-screen operation**  
 Our icon-driven SmartTouch interface leads you through menus, functions and options, enabling you to make any adjustment from the most basic to the most sophisticated, even with your gloves on.
- Fully informative display**  
 Our controllers display it all: Internal bath temperature, external bath temperature, set-point and more. All on one easy to read screen. And our Performance and Advanced Series Temperature Controllers take it one step further – keeping critical temperature information on the display regardless of which of the many menus and functions you are accessing.
- Complete connectivity**  
 PolyScience Temperature Controllers keep you connected to your work – from the other side of your lab or the other side of the world. Ethernet, USB-A and USB-B, RS232, and addressable RS485 connectivity provide multiple options for monitoring and controlling your circulator. There's even an iPhone® application that lets you check status or change the set-point while at your desk or in a meeting.
- Convenience**  
 Want a program to begin running while you're in a meeting? A built-in event scheduler makes it easy. Like to personalize your circulator with a favorite quote or photograph? It's as easy as putting an image on your computer desktop. No matter what you want to do, it's easier with the built-in functionality of a PolyScience SmartTouch Controller. It will even remind you when important routine maintenance is needed.
- Unwavering precision**  
 Behind all this innovative technology are five decades of temperature control experience. 50 years of continual refinements to electronics, sensors, algorithms, and many other elements to ensure that each and every PolyScience Temperature Controller delivers precise, reliable, and stable performance day in, day out, year after year.

## Intuitive User Interface

Relevant information when and where you need it.



### Intuitive User Interface

The SmartTouch Color LCD with 4.3" screen, on Performance Programmable, Advanced Programmable and Performance Digital Controllers.



### Bright, Clear Message Display

Provides information in up to 11 languages; icon-driven functionality.

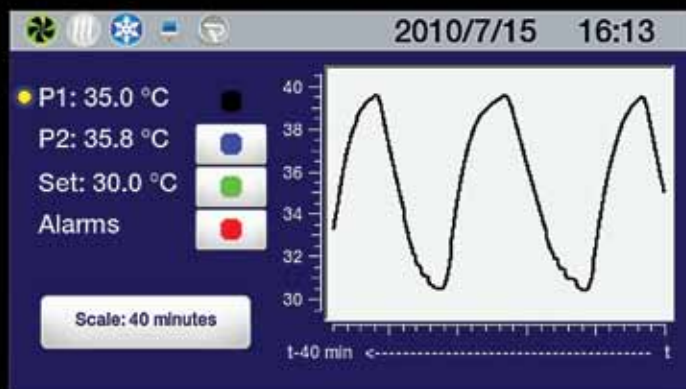

### Selectable Home Screens

Choose the "home screen" that displays the temperature information most useful to you – including temperature trend data for up to 10 days.



### Simple to Operate

Just a few simple touches is all it takes to make a set-point change.

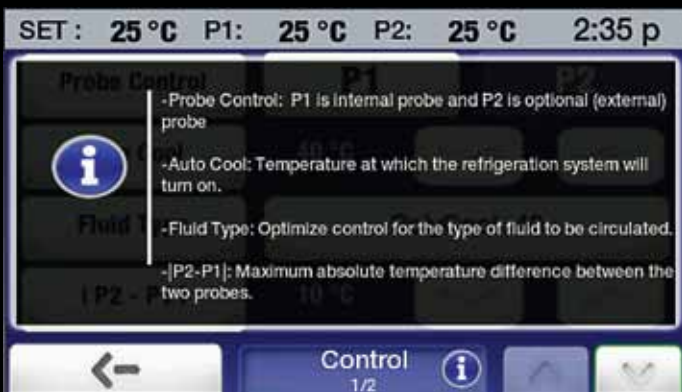

### On-Screen Help Feature

Provides information about the features of each particular screen.

### Convenient Status Bar

“Always on Top” status bar on Performance Programmable, Performance Digital and Advanced Programmable Controllers keeps relevant temperature data in clear view when making operational changes.



### Easy to Understand

Plain text menus and messages take the guesswork out of operation.

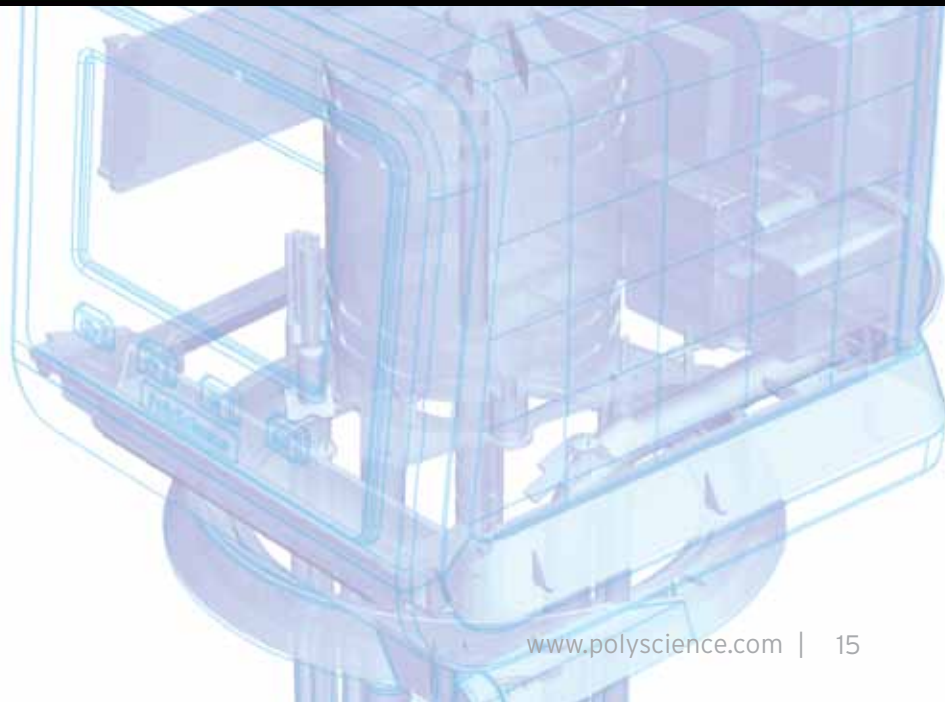

# Performance Programmable Temperature Controller

Delivers the ultimate in precision, performance, and operational flexibility.

Includes Enhanced Performance Hardware & Software Package:

- Pt100 temperature probe for external temperature control
- USB drive for data logging
- Stainless steel tubing fittings and adapters
- PolyScience LabVIEW™ Virtual Instrument (VI)
- iPhone® application download



## Features:

- $\pm 0.005^{\circ}\text{C}$  temperature stability
- $200^{\circ}\text{C}$  maximum temperature
- OpenMode time/temperature programming (no restriction on number of programs or steps)
- Intuitive 4.3" (10.9 cm) SmartTouch display
- 11 languages: French, German, Spanish, Chinese, Portuguese, Russian, Hindi, Arabic, Italian, Korean, English
- Variable-speed pressure/suction pump
- Swivel 180™ Rotating Controller
- On-board connectivity: USB-A & B, Ethernet, RS232/485, remote on/off and external temperature probe
- Event scheduling (time & date) with real-time clock
- Review temperature trends for up to 10 days
- Multiple, selectable "home" screens
- On-screen help
- Automatic and/or user-adjustable performance optimization
- 10-point calibration capability
- Safety Class III (DIN 12876-1)
- External temperature control capability
- Available with DeviceNet™/CANbus, Modbus®, and Profibus® options



## Absolute Precision

Our most precise and sophisticated temperature controller, the Performance Programmable, combines  $\pm 0.005^{\circ}\text{C}$  temperature stability,  $1/1000^{\circ}$  temperature resolution, 10-point user calibration capability, highly advanced fluid tuning, and external temperature control to deliver exacting control at temperatures ranging from  $-40^{\circ}$  to  $+200^{\circ}\text{C}$ .

## Total Control

Create, review and run even the most complex ramp and soak temperature program quickly, easily, and without guesswork. Highly intuitive programming application lets you add, edit or delete steps quickly. Settable time or temperature priority ensures programs run as intended. Plain-text program naming and preview function makes it easy to identify stored programs. Convenient upload/download utility allows you to quickly share or backup stored programs. Plus, the intelligent scheduling application even lets you schedule a program to run automatically – hours, days, weeks, even months in the future.

## Completely Connected

With the Performance Programmable, you can check and control your PolyScience Circulator from the other side of the lab – or the other side of the world! It features an extensive suite of control, data logging, and communications options, including protocols that emulate the communication and command sets of other popular circulating baths. Connectivity capabilities include Ethernet, RS232, addressable RS485, remote on/off, USB-A and USB-B plus software support for LabVIEW™. In addition, a pioneering iPhone® application provides easy mobile access.

## Exceptional Convenience

Multi-language menus, contextual on-screen help, and highly intuitive operation make using the Performance Programmable Controller exceptionally easy. Set-point changes take just a few simple touches. This intelligent controller even alerts you when routine maintenance, such as air filter cleaning, is required.

## Extraordinary Safety

Engineered to Class III flammability requirements (per DIN 12876-1), the Performance Programmable Controller protects your samples, equipment, and processes with a wide variety of safety features, including a redundant over-temperature safety, high and low temperature limits, high and low temperature alarms, and a user-settable safety. A password protected lockout can also be activated that prevents unauthorized set-point and other operational changes.



# Advanced Programmable Temperature Controller

Excellent precision and performance, highly intuitive operation.



## Features:

- $\pm 0.01^{\circ}\text{C}$  temperature stability
- $200^{\circ}\text{C}$  maximum temperature
- Time/temperature programming (ten 100-step programs)
- Intuitive 4.3" (10.9 cm) SmartTouch display
- 6 languages: French, German, Spanish, Chinese, Arabic, English
- Variable-speed pressure/suction pump
- Swivel 180<sup>TM</sup> Rotating Controller
- On-board connectivity: USB-A & B, RS232/RS485, Ethernet and external temperature probe
- Event scheduling (time & date) with real-time clock
- Review temperature trends for up to 10 days
- On-screen help
- Automatic and/or user-adjustable performance optimization
- 5-point calibration capability
- Safety Class III (DIN 12876-1)
- External temperature control capability



## Precise

Maintains temperatures from -40° to +200°C with  $\pm 0.01^\circ\text{C}$  temperature stability. Displays actual bath temperature to  $1/1000^\circ$  temperature resolution and temperature trends from 4 minutes to 10 days. For more precise performance, the Advanced Programmable Controller offers advanced fluid tuning, user-settable temperature averaging on the display, and temperature control of an external application.

## Powerful

Extremely easy to use, the Advanced Programmable Controller's time/temperature programming interface is similar to that featured on the PolyScience Performance Programmable Controller. You can name, add, edit or delete steps quickly. Settable time or temperature priority ensures programs run as intended. Plus for added convenience you can preview, share, or schedule a program to run automatically. The controller can store 10 programs of up to 100 steps each.

## Connected

Extensive connectivity capabilities enable you to control and communicate with your circulator in a wide variety of ways, including Ethernet, RS232, addressable RS485, USB-A and USB-B. For additional communications flexibility, you can even emulate the command protocols of other popular circulating baths and communicate with your circulator using an iPhone®.

## Accessible

On-screen help and intuitive touch screen operation make using the Advanced Programmable Controller exceptionally easy. Set-point changes, programming, and operational changes are simple and fast.

## Safe

Class III flammability rating (per DIN 12876-1), redundant over-temperature protection, high and low temperature limits and alarms alert you instantly to conditions that fall outside normal operating parameters. Lockout capability prevents unauthorized operational changes.

# Performance Digital Temperature Controller

Delivers the ultimate in precision and performance for applications that require exacting control at a precise temperature.

Includes Enhanced Performance Hardware & Software Package:

- Pt100 temperature probe for external temperature control
- USB flash drive for data logging
- Stainless steel tubing fittings and adapters
- PolyScience LabVIEW™ Virtual Instrument (VI)
- iPhone® application download



## Features:

- $\pm 0.005^{\circ}\text{C}$  temperature stability
- $200^{\circ}\text{C}$  maximum temperature
- Intuitive 4.3" (10.9 cm) SmartTouch display
- 11 languages: French, German, Spanish, Chinese, Portuguese, Russian, Hindi, Arabic, Italian, Korean, English
- Variable-speed pressure/suction pump
- Review temperature trends for up to 10 days
- Swivel 180™ Rotating Controller
- User-adjustable high and low temperature limits and alarms
- Multiple, selectable "home" screens
- Event scheduling (time & date) with real-time clock
- On-screen help
- Automatic and/or user-adjustable performance optimization
- On-board connectivity: USB-A & B, Ethernet, RS232/485, remote on/off and external temperature probe
- 10-point calibration capability
- Safety Class III (DIN 12876-1)
- External temperature control capability
- Available with DeviceNet™/CANbus, Modbus®, and Profibus® options



## Exceptional Performance

Designed to provide exceptionally precise control for single set-point applications, the Performance Digital Controller delivers  $\pm 0.005^\circ$  stability at temperatures ranging from  $-40^\circ$  to  $+200^\circ\text{C}$  and displays temperature to  $1/1000^\circ$ . Other precision-enhancing features include 10-point calibration capability, advanced fluid tuning and remote temperature control of external applications.

## Unequaled Connectivity

The Performance Digital's extensive suite of control, data logging, and communications options make it easy to integrate into your lab's communication platform. Connectivity capabilities include Ethernet, remote on/off, RS232, addressable RS485, and USB A and USB B plus command and communication protocols for other popular circulating baths. There's even an iPhone® application that lets you check bath status or change the temperature set-point from remote locations.

## Global Convenience

Icon-driven multi-language menus and contextual on-screen help guide you quickly through setup and operation. One-touch access with flexible temperature entry makes set-point changes fast and straightforward. User-settable reminders automatically alert you when routine maintenance is required.

## Outstanding Safety

Over-temperature and low-liquid level protection (DIN 12876-1 Class III flammability rating), redundant over-temperature protection, high and low temperature limits and alarms provide exceptional safety and peace of mind. In addition, there's a password protected lockout to help prevent accidental or unauthorized operational changes.

## Advanced Digital Temperature Controller

Combines exceptional precision and performance with highly intuitive, feature-rich operation.



### Features:

- $\pm 0.01^{\circ}\text{C}$  temperature stability
- $200^{\circ}\text{C}$  maximum temperature
- Intuitive 3.75" (9.5 cm) display with touch-pad control
- 4 languages: French, German, Spanish, English
- Variable-speed pressure/suction pump
- Swivel 180<sup>TM</sup> Rotating Controller
- User-adjustable high and low temperature limits and alarms
- On-screen prompts
- Automatic performance optimization and specific heat tuning
- On-board connectivity: USB-A & B, RS232/485, Ethernet and external temperature probe
- Single-point calibration
- Safety Class III (DIN 12876-1)
- External temperature control capability



## Optimized

The Advanced Digital Temperature Controller displays and controls both temperatures from -40° to +200°C with 0.01°C precision and stability. Plus, you can further optimize performance through a variety of control settings including pump speed, specific heat value, calibration offset, and internal or external temperature control. You can even set the temperature at which the refrigeration engages.

## Communicative

Bi-directional RS232, RS485, and Ethernet communications provide fast and versatile remote control and data logging. USB-A and USB-B enable you to log data directly to a flash drive or computer.

## Friendly

On-screen prompts and 4 languages (English, Spanish, French, and German) take the guesswork out of setup and operation. Adjusting the temperature set-point, pump speed, or other operating settings is simple, straightforward and intuitive. In addition, the Advanced Digital Temperature Controller features a message bar that assists in making changes and provides alerts and safety information.

## Class III Safety

Rated for use with Class III flammable liquids (per DIN 12876-1), the Advanced Digital Temperature Controller delivers exceptional safety for a wide variety of laboratory applications. Standard safety features include redundant over-temperature and low-liquid level protection, user-settable over-temperature safety and high and low temperature limits.

## Standard Digital Temperature Controller

Combines innovative design with highly intuitive operation to deliver reliable temperature control for a wide range of laboratory applications.



### Features:

- $\pm 0.04^{\circ}\text{C}$  temperature stability
- $170^{\circ}\text{C}$  maximum temperature
- Large, universal icon and English display
- 2-speed pressure pump
- Swivel  $180^{\circ}$  Rotating Controller
- Automatic performance optimization
- User-adjustable high and low temperature limits and alarms
- On-board connectivity: RS232 serial output
- Single-point calibration
- Safety Class I (DIN 12876-1)



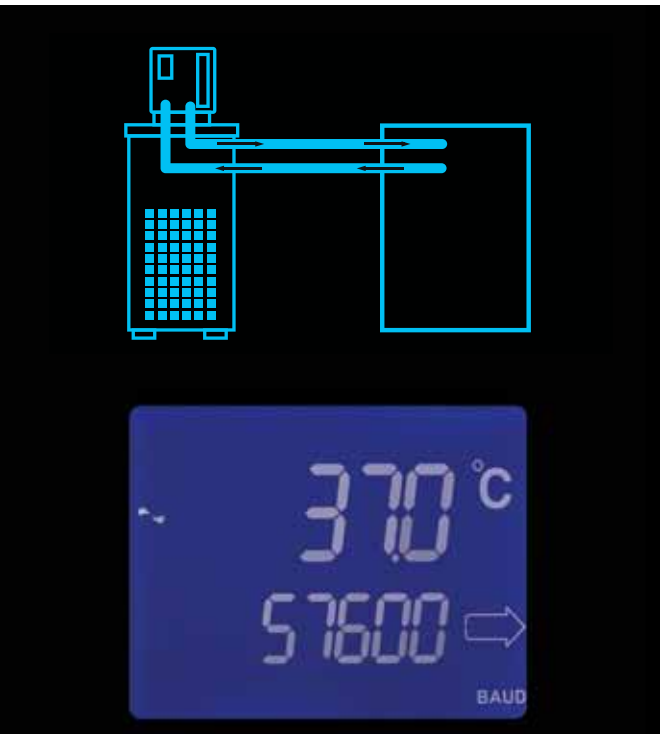

## Reliable

Set and read to 0.1°C, 170°C maximum temperature,  $\pm 0.04^\circ\text{C}$  temperature stability, and a 2-speed pump make the Standard Digital Temperature Controller an economical and reliable choice for a variety of laboratory applications, including those requiring closed-loop external circulation. Cool Command™ functionality permits faster cool downs from high temperatures.

## Communication

RS232 serial communication capability allows control and data logging via a PC or other remote device.



## Intuitive Operation

Plain-text prompts and intuitive controls guide you quickly through setup. Intelligent touch and scroll display makes it easy to make both large and small set-point adjustments.



## Protection

User-settable high-temperature safety provides over-temperature and low-liquid-level protection, and adjustable high and low limits guard against unintended set-point changes.

# MX Temperature Controller

The flexibility of a fully integrated temperature controller or clamp-on immersion circulator.



## Features:

- $\pm 0.07^{\circ}\text{C}$  temperature stability
- $135^{\circ}\text{C}$  maximum temperature
- Large, universal icon and English display
- Single-speed pressure pump
- User-adjustable high and low temperature limits and alarms
- On-screen prompts
- Single-point calibration
- Safety Class I (DIN 12876-1)



## Versatile

The MX Temperature Controller is available as either a fully integrated bath model or as a clamp-on immersion circulator you can mount to your own bath or tank. In either configuration, it delivers  $\pm 0.07^\circ\text{C}$  temperature stability at temperatures as high as  $135^\circ\text{C}$ .



## Intuitive

Three control buttons and plain-text on-screen prompts make the setup and operation of the MX Temperature Controller easy and straightforward.



## Safe

User-settable high-temperature safety provides over-temperature and low-liquid-level protection and integrated (patent-pending) design protects pump and heater while simplifying cleaning and maintenance.

# Temperature Controller Selection Guide

Controller Type	Performance Programmable	Advanced Programmable
Maximum Temperature	200°C	200°C
Temperature Stability	±0.005°C	±0.01°C
Swivel 180™ Rotating Controller	•	•
Pump	Variable-speed	Variable-speed
Pump Pressure (maximum) psi (bar)*	4.3 (0.3)	4.3 (0.3)
Pressure Flow Rate (maximum) gpm (l/min)*	5.3 (20.1)	5.3 (20.1)
Suction Flow Rate (maximum) gpm (l/min)*	3.9 (14.7)	3.9 (14.7)
Closed-Loop Operation	•	•
Open-Loop Operation	•	•
Fluid Optimization/Specific Heat Tuning	•	•
Temperature Calibration Capability	10-point	5-point
WhisperCool™ Environmental Control System	•	•
Inert Gas Reservoir Purge	•	•
Display Type & Size	SmartTouch Color LCD 4.3"	SmartTouch Color LCD 4.3"
Enhanced Data Display Capability	7 selectable views	7 selectable views
Multi-Language Menus or Prompts	11 languages	6 languages
Displays Temperature Trend	•	•
Time/Temperature Programs & Steps	OpenMode	Ten 100 step programs
Date & Time with Calendar Start/Stop	•	•
Timer	•	•
On-Screen Help or Prompts	•	•
External Temperature Control Capability (Pt100)	•	•
RS232/RS485 Serial Output	•	•
Remote On/Off Capability	•	•
USB-A and USB-B	•	•
Ethernet	•	•
DeviceNet™/Canbus, Modbus®, Profibus® (optional)	•	•
Software Support for LabVIEW™ Included	•	•
Backlit Display	•	•
Automatic Loss of Power Reset	Selectable	Selectable
Safety Class (DIN 12876-1)	III	III
Over-Temperature Protection	•	•
Failsafe Heater Control	•	•
High and Low Temperature Limits/Alarms	•	•
Low-Liquid-Level Safety	•	•
Alarm and Fault Indicators	Message	Message

\*Specifications for 60Hz models.

Performance Digital	Advanced Digital	Standard Digital	MX
200°C	200°C	170°C	135°C
±0.005°C	±0.01°C	±0.04°C	±0.07°C
•	•	•	
Variable-speed	Variable-speed	2-speed	1-speed
4.3 (0.3)	4.3 (0.3)	3.5 (.24)	1.8 (.12)
5.3 (20.1)	5.3 (20.1)	2.9 (11.0)	3.4 (12.8)
3.9 (14.7)	3.9 (14.7)		
•	•	•	•
•	•		
•	•		
10-point	1-point	1-point	1-point
•	•	•	•
•	•	•	
SmartTouch Color LCD 4.3"	LCD Touch-Pad 3.75"	LCD Touch-Pad 3.75"	LCD 3.25"
6 selectable views	Message bar		
11 languages	4 languages	Icon/English	Icon/English
•			
•			
•	•		
•	•		
•	•		
•	•	RS232	
•			
•	•		
•	•		
•			
•	•	•	•
Selectable	Selectable	Yes	Yes
III	III	I	I
•	•	•	•
•	•	•	•
•	•	•	•
•	•	•	•
Message	Message	Icon	Icon

# Refrigerated Circulating Baths

A versatile range of products to fit every need.

Features:

- Working temperatures from -40 to +200°C
- Temperature stabilities to  $\pm 0.005^\circ\text{C}$
- Capacities from 7 to 45 liters
- Six controller types with large, intuitive displays and multiple communication options
- Large bath openings and easy to clean surfaces
- Swivel 180<sup>TM</sup> Rotating Controllers
- LidDock<sup>TM</sup> Lid Stowing System
- DuraTop<sup>TM</sup> Chemical Resistant Deck
- WhisperCool<sup>TM</sup> Environmental Control System
- Cool Command<sup>TM</sup> Technology

Capable of reaching temperatures as low as  $-40^\circ\text{C}$ , PolyScience Refrigerated/Heated Circulating Baths provide dependable temperature control for a wide variety of laboratory cooling applications.



Available in 40 different models, the latest generation PolyScience Refrigerated/Heated Circulating Baths uphold our reputation for innovation, product quality, and refrigeration expertise. Our lab and operator-friendly circulating baths set a new industry standard for design, performance and value. The units are extremely simple to operate, easy to install and maintain, and will provide years of reliable and accurate heat removal.

PolyScience Refrigerated/Heated Circulators come with the following accessories:

- Reservoir cover
- Bypass tubing
- Male inlet and outlet adapters for 3/8, 1/4, and 3/16" (.95, .63, and .47 cm) tubing. 1/4" to M16 adapters also included on 50 Hz units.
- 6' (1.83 m) standard grounded electrical cord with country-specific plug





## Features:

- **Quiet**  
Proprietary patent-pending WhisperCool™ technology reduces overall equipment noise, increases refrigeration efficiency, and lowers energy consumption.
- **Easy to maintain**  
Accessing the reservoir drain and removable air filter for maintenance is as simple as removing the circulator's front panel. Performance Programmable, Advanced Programmable and Performance Digital models even remind you when it's time for filter cleaning.
- **Energy saving**  
Cool Command™ technology carefully regulates the amount of cooling required, saving energy while delivering fast cool-downs and more precise control at elevated temperatures.
- **Safe**  
All models feature user-settable high-temperature safeties as well as redundant over-temperature protection and comply with RoHS, WEEE, IEC 61010-1, IEC 61010-2-010, IEC 61326-1, DIN 12876 and are CE and ETL certified. Our DuraTop™ surface is cooler to the touch when operating at high temperatures.
- **Intuitive**  
Whether equipped with the entry-level controller or the most sophisticated, PolyScience Refrigerated/Heated Circulating Baths are extremely easy to use. Clear navigational buttons and menu prompts guide you through setup, making operational and temperature set-point changes simple and precise.

# Refrigerated Circulating Baths Selection Guide



	Capacity	7 Liter (Low Profile)	7 Liter	7 Liter
	Maximum Temperature <sup>1</sup>	200°C	200°C	200°C
	Minimum Temperature	-20°C	-20°C	-40°C
	Cooling Capacity @ 20°C	200 W	200 W	505 W
	Working Access (L x W x D)	6.18 x 5.59 x 5" 15.7 x 14.2 x 12.7 cm	6.18 x 5.59 x 5" 15.7 x 14.2 x 12.7 cm	6.18 x 5.59 x 5" 15.7 x 14.2 x 12.7 cm
	Drain	•	•	•
	LidDock™	•	•	•
Part Number	Performance Programmable 120 VAC/60 Hz	PP7LR-20-A11B	PP07R-20-A11B	PP07R-40-A11B
		PP7LR-20-A12E	PP07R-20-A12E	PP07R-40-A12E
	Advanced Programmable 120 VAC/60 Hz	AP7LR-20-A11B	AP07R-20-A11B	AP07R-40-A11B
		AP7LR-20-A12E	AP07R-20-A12E	AP07R-40-A12E
	Performance Digital 120 VAC/60 Hz	PD7LR-20-A11B	PD07R-20-A11B	PD07R-40-A11B
		PD7LR-20-A12E	PD07R-20-A12E	PD07R-40-A12E
	Advanced Digital 120 VAC/60 Hz	AD7LR-20-A11B	AD07R-20-A11B	AD07R-40-A11B
		AD7LR-20-A12E	AD07R-20-A12E	AD07R-40-A12E
	Standard Digital 120 VAC/60 Hz	SD7LR-20-A11B	SD07R-20-A11B	
		SD7LR-20-A12E	SD07R-20-A12E	
	MX 120 VAC/60 Hz	MX7LR-20-A11B	MX07R-20-A11B	
		MX7LR-20-A12E	MX07R-20-A12E	

1. Maximum temperature is controller dependent; see Circulator Controller Features, pages 16 through 27.

2. All 45L Circulating Baths are 208-240 VAC, 50/60 Hz.

Electrical plugs for the part numbers listed are standard U.S. and European types. See page 128 for additional plug types and part numbers.





15 Liter

15 Liter

20 Liter

28 Liter

45 Liter<sup>2</sup>

200°C

200°C

200°C

200°C

135°C

-30°C

-40°C

-30°C

-30°C

-25°C

915 W

1000 W

915 W

915 W

1400 W

8.35 x 10.88 x 5.5"  
21.2 x 27.6 x 14 cm

8.35 x 10.88 x 5.5"  
21.2 x 27.6 x 14 cm

9.85 x 12.45 x 5.5"  
25 x 31.6 x 14 cm

12.35 x 14.13 x 5.5"  
31.4 x 35.9 x 14 cm

21.6 x 15.68 x 5.5"  
54.9 x 39.8 x 14 cm

•

•

•

•

•

•

•

•

•

PP15R-30-A11B

PP15R-40-A11B

PP20R-30-A11B

PP28R-30-A11B

PP45R-20-A13D

PP15R-30-A12E

PP15R-40-A12E

PP20R-30-A12E

PP28R-30-A12E

PP45R-20-A12E

AP15R-30-A11B

AP15R-40-A11B

AP20R-30-A11B

AP28R-30-A11B

AP45R-20-A13D

AP15R-30-A12E

AP15R-40-A12E

AP20R-30-A12E

AP28R-30-A12E

AP45R-20-A12E

PD15R-30-A11B

PD15R-40-A11B

PD20R-30-A11B

PD28R-30-A11B

PD45R-20-A13D

PD15R-30-A12E

PD15R-40-A12E

PD20R-30-A12E

PD28R-30-A12E

PD45R-20-A12E

AD15R-30-A11B

AD15R-40-A11B

AD20R-30-A11B

AD28R-30-A11B

AD45R-20-A13D

AD15R-30-A12E

AD15R-40-A12E

AD20R-30-A12E

AD28R-30-A12E

AD45R-20-A12E

SD15R-30-A11B

SD20R-30-A11B

SD28R-30-A11B

SD15R-30-A12E

SD20R-30-A12E

SD28R-30-A12E

MX15R-30-A11B

MX20R-30-A11B

MX15R-30-A12E

MX20R-30-A12E

# Performance Programmable Temperature Controller

## Key Specifications

Working Temperature: From -40°C to +200°C

Temperature Stability: ±0.005°C

Maximum Pressure: psi (bar)

120 VAC/60 Hz Models 4.3 (0.3)

240 VAC/50 Hz Models 3.6 (0.25)

Maximum Flow Rate:	Pressure	Suction
	gpm (l/min)	gpm (l/min)
120 VAC/60 Hz Models	5.3 (20.1)	3.9 (14.7)
240 VAC/50 Hz Models	4.4 (16.7)	3.2 (12.2)

120 VAC/60 Hz Models

5.3 (20.1)

3.9 (14.7)

240 VAC/50 Hz Models

4.4 (16.7)

3.2 (12.2)



## Features:

- OpenMode time/temperature programming (no restriction on number of programs or steps)
- Intuitive 4.3" (10.9 cm) SmartTouch display
- 11 languages: French, German, Spanish, Chinese, Portuguese, Russian, Hindi, Arabic, Italian, Korean, English
- Variable-speed pressure/suction pump with external circulation and temperature control capability
- Swivel 180™, LidDock™, DuraTop™, WhisperCool™, Cool Command™
- On-board connectivity: USB-A & B, Ethernet, RS232/485, remote on/off, external temperature probe
- Event scheduling (time & date), real-time clock and temperature trends for up to 10 days
- Multiple, selectable "home" screens and on-screen help
- Automatic and/or user-adjustable performance optimization and 10-point calibration capability
- Complies with DIN 12876-1 Class III safety requirements for use with flammable liquids
- Includes Enhanced Performance Hardware & Software Package
- Available with DeviceNet™/CANbus, Modbus®, and Profibus® options



Temperature control is easily fine-tuned through the selection of a specific fluid, entry of a fluid's specific heat capacity, or even the adjustment of the controller's PID values.

Simple and intuitive time/temperature programming makes it easy to create and run special test protocols and/or ramp and soak profiles.

Selectable "Home" screens allow you to display as much or as little temperature information as you need – including 4 minute to 10 day temperature trend data.

For additional information on the Performance Programmable Controller's features and capabilities, see pages 16 and 17.



**7-Liter: -20°C, Low-Profile**

Temperature Range:  
-20° to +200°C

Working Access (L x W x D):  
6.18 x 5.59 x 5"  
15.7 x 14.2 x 12.7 cm

Overall Dimensions (L x W x H):  
23.2 x 16.2 x 16.2"  
58.9 x 41.1 x 41.1 cm

**7-Liter: -20°C**

Temperature Range:  
-20° to +200°C

Working Access (L x W x D):  
6.18 x 5.59 x 5"  
15.7 x 14.2 x 12.7 cm

Overall Dimensions (L x W x H):  
21.3 x 8.7 x 24.3"  
54.1 x 22.1 x 61.7 cm

**7-Liter: -40°C**

Temperature Range:  
-40° to +200°C

Working Access (L x W x D):  
6.18 x 5.59 x 5"  
15.7 x 14.2 x 12.7 cm

Overall Dimensions (L x W x H):  
21.3 x 8.7 x 24.3"  
54.1 x 22.1 x 61.7 cm

**15-Liter: -30°C**

Temperature Range:  
-30° to +200°C

Working Access (L x W x D):  
8.35 x 10.88 x 5.5"  
21.2 x 27.6 x 14 cm

Overall Dimensions (L x W x H):  
22.4 x 14.5 x 26.9"  
56.9 x 36.8 x 68.3 cm



**15-Liter: -40°C**

Temperature Range:  
-40° to +200°C

Working Access (L x W x D):  
8.35 x 10.88 x 5.5"  
21.2 x 27.6 x 14 cm

Overall Dimensions (L x W x H):  
22.4 x 14.5 x 26.9"  
56.9 x 36.8 x 68.3 cm

**20-Liter: -30°C**

Temperature Range:  
-30° to +200°C

Working Access (L x W x D):  
9.85 x 12.45 x 5.5"  
25 x 31.6 x 14 cm

Overall Dimensions (L x W x H):  
24 x 16.6 x 26.9"  
61 x 41.9 x 68.3 cm

**28-Liter: -30°C**

Temperature Range:  
-30° to +200°C

Working Access (L x W x D):  
12.35 x 14.13 x 5.5"  
31.4 x 35.9 x 14 cm

Overall Dimensions (L x W x H):  
26.5 x 18.0 x 26.9"  
67.2 x 45.7 x 68.3 cm

**45-Liter: -25°C**

Temperature Range:  
-25° to +135°C

Working Access (L x W x D):  
21.6 x 15.68 x 5.5"  
54.9 x 39.8 x 14 cm

Overall Dimensions (L x W x H):  
35.8 x 22.4 x 42.1"  
90.9 x 56.8 x 107 cm



Reservoir Size	7 Liter Low-Profile	7 Liter		15 Liter		20 Liter	28 Liter	45 Liter <sup>1</sup>
Temperature Range	-20° to +200°C	-20° to +200°C	-40° to +200°C	-30° to +200°C	-40° to +200°C	-30° to +200°C	-30° to +200°C	-25° to +135°C
Cooling Capacity @ 20°C	200 W	200 W	505 W	915 W	1000 W	915 W	915 W	1400 W
Heater	1100 W (60 Hz)/2200 W (50 Hz)							2200 W (50/60 Hz)
Part Number 120 VAC/60 Hz	PP7LR-20-A11B	PP07R-20-A11B	PP07R-40-A11B	PP15R-30-A11B	PP15R-40-A11B	PP20R-30-A11B	PP28R-30-A11B	PP45R-20-A13D
Part Number 240 VAC/50 Hz	PP7LR-20-A12E	PP07R-20-A12E	PP07R-40-A12E	PP15R-30-A12E	PP15R-40-A12E	PP20R-30-A12E	PP28R-30-A12E	PP45R-20-A12E

1. 45 liter bath is 208-240 VAC, 50/60 Hz

Electrical plugs for the part numbers listed are standard U.S. and European types. See page 128 for additional plug types and part numbers.

# Advanced Programmable Temperature Controller

## Key Specifications

Working Temperature: From -40°C to +200°C

Temperature Stability:  $\pm 0.01^\circ\text{C}$

Maximum Pressure: psi (bar)

120 VAC/60 Hz Models 4.3 (0.3)

240 VAC/50 Hz Models 3.6 (0.25)

Maximum Flow Rate:	Pressure	Suction
	gpm (l/min)	gpm (l/min)
120 VAC/60 Hz Models	5.3 (20.1)	3.9 (14.7)
240 VAC/50 Hz Models	4.4 (16.7)	3.2 (12.2)



## Features:

- Time/temperature programming (ten 100-step programs)
- Intuitive 4.3" (10.9 cm) SmartTouch display
- 6 languages: French, German, Spanish, Chinese, Arabic, English
- Variable-speed pressure/suction pump with external circulation and temperature control capability
- Swivel 180™, LidDock™, DuraTop™, WhisperCool™, Cool Command™
- On-board connectivity: USB-A & B, RS232/485, Ethernet and external temperature probe
- Event scheduling (time & date), real-time clock and temperature trends for up to 10 days
- Selectable "home" screens and on-screen help
- Automatic and/or user-adjustable performance optimization
- 5-point calibration capability
- Complies with DIN 12876-1 Class III safety requirements for use with flammable liquids



Special features, such as the ability to select time or temperature as the priority and preview the resulting temperature profile, eliminate the guesswork when creating time/temperature programs.

Extensive communication capability enables you to easily check circulator status.

For additional information on the Advanced Programmable Controller's features and capabilities, see pages 18 and 19.



**7-Liter: -20°C, Low-Profile**

Temperature Range:  
-20° to +200°C

Working Access (L x W x D):  
6.18 x 5.59 x 5"  
15.7 x 14.2 x 12.7 cm

Overall Dimensions (L x W x H):  
23.2 x 16.2 x 16.2"  
58.9 x 41.1 x 41.1 cm

**7-Liter: -20°C**

Temperature Range:  
-20° to +200°C

Working Access (L x W x D):  
6.18 x 5.59 x 5"  
15.7 x 14.2 x 12.7 cm

Overall Dimensions (L x W x H):  
21.3 x 8.7 x 24.3"  
54.1 x 22.1 x 61.7 cm

**7-Liter: -40°C**

Temperature Range:  
-40° to +200°C

Working Access (L x W x D):  
6.18 x 5.59 x 5"  
15.7 x 14.2 x 12.7 cm

Overall Dimensions (L x W x H):  
21.3 x 8.7 x 24.3"  
54.1 x 22.1 x 61.7 cm

**15-Liter: -30°C**

Temperature Range:  
-30° to +200°C

Working Access (L x W x D):  
8.35 x 10.88 x 5.5"  
21.2 x 27.6 x 14 cm

Overall Dimensions (L x W x H):  
22.4 x 14.5 x 26.9"  
56.9 x 36.8 x 68.3 cm



**15-Liter: -40°C**

Temperature Range:  
-40° to +200°C

Working Access (L x W x D):  
8.35 x 10.88 x 5.5"  
21.2 x 27.6 x 14 cm

Overall Dimensions (L x W x H):  
22.4 x 14.5 x 26.9"  
56.9 x 36.8 x 68.3 cm

**20-Liter: -30°C**

Temperature Range:  
-30° to +200°C

Working Access (L x W x D):  
9.85 x 12.45 x 5.5"  
25 x 31.6 x 14 cm

Overall Dimensions (L x W x H):  
24 x 16.6 x 26.9"  
61 x 41.9 x 68.3 cm

**28-Liter: -30°C**

Temperature Range:  
-30° to +200°C

Working Access (L x W x D):  
12.35 x 14.13 x 5.5"  
31.4 x 35.9 x 14 cm

Overall Dimensions (L x W x H):  
26.5 x 18 x 26.9"  
67.2 x 45.7 x 68.3 cm

**45-Liter: -25°C**

Temperature Range:  
-25° to +135°C

Working Access (L x W x D):  
21.6 x 15.68 x 5.5"  
54.9 x 39.8 x 14 cm

Overall Dimensions (L x W x H):  
35.8 x 22.4 x 42.1"  
90.9 x 56.8 x 107 cm



Reservoir Size	7 Liter Low-Profile	7 Liter		15 Liter		20 Liter	28 Liter	45 Liter <sup>1</sup>
Temperature Range	-20° to +200°C	-20° to +200°C	-40° to +200°C	-30° to +200°C	-40° to +200°C	-30° to +200°C	-30° to +200°C	-25° to +135°C
Cooling Capacity @ 20°C	200 W	200 W	505 W	915 W	1000 W	915 W	915 W	1400 W
Heater	1100 W (60 Hz)/2200 W (50 Hz)							2200 W (50/60 Hz)
Part Number 120 VAC/60 Hz	AP7LR-20-A11B	AP07R-20-A11B	AP07R-40-A11B	AP15R-30-A11B	AP15R-40-A11B	AP20R-30-A11B	AP28R-30-A11B	AP45R-20-A13D
Part Number 240 VAC/50 Hz	AP7LR-20-A12E	AP07R-20-A12E	AP07R-40-A12E	AP15R-30-A12E	AP15R-40-A12E	AP20R-30-A12E	AP28R-30-A12E	AP45R-20-A12E

1. 45 liter bath is 208-240 VAC, 50/60 Hz

Electrical plugs for the part numbers listed are standard U.S. and European types. See page 128 for additional plug types and part numbers.

# Performance Digital Temperature Controller

## Key Specifications

Working Temperature: From -40°C to +200°C

Temperature Stability: ±0.005°C

Maximum Pressure: psi (bar)

120 VAC/60 Hz Models 4.3 (0.3)

240 VAC/50 Hz Models 3.6 (0.25)

Maximum Flow Rate:	Pressure	Suction
	gpm (l/min)	gpm (l/min)
120 VAC/60 Hz Models	5.3 (20.1)	3.9 (14.7)
240 VAC/50 Hz Models	4.4 (16.7)	3.2 (12.2)

120 VAC/60 Hz Models 5.3 (20.1) 3.9 (14.7)

240 VAC/50 Hz Models 4.4 (16.7) 3.2 (12.2)



## Features:

- Intuitive 4.3" (10.9 cm) SmartTouch display
- 11 languages: French, German, Spanish, Chinese, Portuguese, Russian, Hindi, Arabic, Italian, Korean, English
- Variable-speed pressure/suction pump with external circulation and temperature control capability
- Swivel 180™, LidDock™, DuraTop™, WhisperCool™, Cool Command™
- On-board connectivity: USB-A & B, Ethernet, RS232/485, remote on/off and external temperature probe
- Event scheduling (time & date) with real-time clock and temperature trends for up to 10 days
- Multiple, selectable “home” screens and on-screen help
- Automatic and/or user-adjustable performance optimization and 10-point calibration capability
- Complies with DIN 12876-1 Class III safety requirements for use with flammable liquids
- Includes Enhanced Performance Hardware & Software Package
- Available with DeviceNet™/CANbus, Modbus®, and Profibus® options



Highly intuitive touch screen interface makes setup and operation simple and straightforward.

Just a touch of your finger is all it takes to access on-board support – in any of 11 different languages.

For additional information on the Performance Digital Controller’s features and capabilities, see pages 20 and 21.

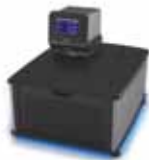
**7-Liter: -20°C, Low-Profile**Temperature Range:  
-20° to +200°CWorking Access (L x W x D):  
6.18 x 5.59 x 5"  
15.7 x 14.2 x 12.7 cmOverall Dimensions (L x W x H):  
23.2 x 16.2 x 16.2"  
58.9 x 41.1 x 41.1 cm**7-Liter: -20°C**Temperature Range:  
-20° to +200°CWorking Access (L x W x D):  
6.18 x 5.59 x 5"  
15.7 x 14.2 x 12.7 cmOverall Dimensions (L x W x H):  
21.3 x 8.7 x 24.3"  
54.1 x 22.1 x 61.7 cm**7-Liter: -40°C**Temperature Range:  
-40° to +200°CWorking Access (L x W x D):  
6.18 x 5.59 x 5"  
15.7 x 14.2 x 12.7 cmOverall Dimensions (L x W x H):  
21.3 x 8.7 x 24.3"  
54.1 x 22.1 x 61.7 cm**15-Liter: -30°C**Temperature Range:  
-30° to +200°CWorking Access (L x W x D):  
8.35 x 10.88 x 5.5"  
21.2 x 27.6 x 14 cmOverall Dimensions (L x W x H):  
22.4 x 14.5 x 26.9"  
56.9 x 36.8 x 68.3 cm**15-Liter: -40°C**Temperature Range:  
-40° to +200°CWorking Access (L x W x D):  
8.35 x 10.88 x 5.5"  
21.2 x 27.6 x 14 cmOverall Dimensions (L x W x H):  
22.4 x 14.5 x 26.9"  
56.9 x 36.8 x 68.3 cm**20-Liter: -30°C**Temperature Range:  
-30° to +200°CWorking Access (L x W x D):  
9.85 x 12.45 x 5.5"  
25 x 31.6 x 14 cmOverall Dimensions (L x W x H):  
24 x 16.6 x 26.9"  
61 x 41.9 x 68.3 cm**28-Liter: -30°C**Temperature Range:  
-30° to +200°CWorking Access (L x W x D):  
12.35 x 14.13 x 5.5"  
31.4 x 35.9 x 14 cmOverall Dimensions (L x W x H):  
26.5 x 18 x 26.9"  
67.2 x 45.7 x 68.3 cm**45-Liter: -25°C**Temperature Range:  
-25° to +135°CWorking Access (L x W x D):  
21.6 x 15.68 x 5.5"  
54.9 x 39.8 x 14 cmOverall Dimensions (L x W x H):  
35.8 x 22.4 x 42.1"  
90.9 x 56.8 x 107 cm

Reservoir Size	7 Liter Low-Profile	7 Liter		15 Liter		20 Liter	28 Liter	45 Liter <sup>1</sup>
Temperature Range	-20° to +200°C	-20° to +200°C	-40° to +200°C	-30° to +200°C	-40° to +200°C	-30° to +200°C	-30° to +200°C	-25° to +135°C
Cooling Capacity @ 20°C	200 W	200 W	505 W	915 W	1000 W	915 W	915 W	1400 W
Heater	1100 W (60 Hz)/2200 W (50 Hz)							2200 W (50/60 Hz)
Part Number 120 VAC/60 Hz	PD7LR-20-A11B	PD07R-20-A11B	PD07R-40-A11B	PD15R-30-A11B	PD15R-40-A11B	PD20R-30-A11B	PD28R-30-A11B	PD45R-20-A13D
Part Number 240 VAC/50 Hz	PD7LR-20-A12E	PD07R-20-A12E	PD07R-40-A12E	PD15R-30-A12E	PD15R-40-A12E	PD20R-30-A12E	PD28R-30-A12E	PD45R-20-A12E

1. 45 liter bath is 208-240 VAC, 50/60 Hz

Electrical plugs for the part numbers listed are standard U.S. and European types. See page 128 for additional plug types and part numbers.

# Advanced Digital Temperature Controller

Key Specifications

Working Temperature: From -40°C to +200°C

Temperature Stability: ±0.01°C

Maximum Pressure:	psi (bar)	
120 VAC/60 Hz Models	4.3 (0.3)	
240 VAC/50 Hz Models	3.6 (0.25)	

Maximum Flow Rate:	Pressure	Suction
	gpm (l/min)	gpm (l/min)
120 VAC/60 Hz Models	5.3 (20.1)	3.9 (14.7)
240 VAC/50 Hz Models	4.4 (16.7)	3.2 (12.2)



## Features:

- Intuitive 3.75" (9.5 cm) display with touch-pad control
- 4 languages: French, German, Spanish, English
- Variable-speed pressure/suction pump with external circulation and temperature control capability
- Swivel 180™, LidDock™, DuraTop™, WhisperCool™, Cool Command™
- On-board connectivity: USB-A & B, RS232/485, Ethernet and external temperature probe
- Automatic and/or user-adjustable performance optimization
- Single-point calibration
- Complies with DIN 12876-1 Class III safety requirements for use with flammable liquids



Alpha-numeric message bar guides you through setup and provides important operational information.



For further optimization of temperature control, you can easily input the specific heat capacity value for the heat transfer fluid that you're using.

For additional information on the Advanced Digital Controller's features and capabilities, see pages 22 and 23.





7-Liter: -20°C, Low-Profile	7-Liter: -20°C	7-Liter: -40°C	15-Liter: -30°C
-----------------------------	----------------	----------------	-----------------

Temperature Range:  
-20° to +200°C

Working Access (L x W x D):  
6.18 x 5.59 x 5"  
15.7 x 14.2 x 12.7 cm

Overall Dimensions (L x W x H):  
23.2 x 16.2 x 16.2"  
58.9 x 41.1 x 41.1 cm

Temperature Range:  
-20° to +200°C

Working Access (L x W x D):  
6.18 x 5.59 x 5"  
15.7 x 14.2 x 12.7 cm

Overall Dimensions (L x W x H):  
21.3 x 8.7 x 24.3"  
54.1 x 22.1 x 61.7 cm

Temperature Range:  
-40° to +200°C

Working Access (L x W x D):  
6.18 x 5.59 x 5"  
15.7 x 14.2 x 12.7 cm

Overall Dimensions (L x W x H):  
21.3 x 8.7 x 24.3"  
54.1 x 22.1 x 61.7 cm

Temperature Range:  
-30° to +200°C

Working Access (L x W x D):  
8.35 x 10.88 x 5.5"  
21.2 x 27.6 x 14 cm

Overall Dimensions (L x W x H):  
22.4 x 14.5 x 26.9"  
56.9 x 36.8 x 68.3 cm



15-Liter: -40°C	20-Liter: -30°C	28-Liter: -30°C	45-Liter: -25°C
-----------------	-----------------	-----------------	-----------------

Temperature Range:  
-40° to +200°C

Working Access (L x W x D):  
8.35 x 10.88 x 5.5"  
21.2 x 27.6 x 14 cm

Overall Dimensions (L x W x H):  
22.4 x 14.5 x 26.9"  
56.9 x 36.8 x 68.3 cm

Temperature Range:  
-30° to +200°C

Working Access (L x W x D):  
9.85 x 12.45 x 5.5"  
25 x 31.6 x 14 cm

Overall Dimensions (L x W x H):  
24 x 16.6 x 26.9"  
61 x 41.9 x 68.3 cm

Temperature Range:  
-30° to +200°C

Working Access (L x W x D):  
12.35 x 14.13 x 5.5"  
31.4 x 35.9 x 14 cm

Overall Dimensions (L x W x H):  
26.5 x 18 x 26.9"  
67.2 x 45.7 x 68.3 cm

Temperature Range:  
-25° to +135°C

Working Access (L x W x D):  
21.6 x 15.68 x 5.5"  
54.9 x 39.8 x 14 cm

Overall Dimensions (L x W x H):  
35.8 x 22.4 x 42.1"  
90.9 x 56.8 x 107 cm



Reservoir Size	7 Liter Low-Profile	7 Liter		15 Liter		20 Liter	28 Liter	45 Liter <sup>1</sup>
Temperature Range	-20° to +200°C	-20° to +200°C	-40° to +200°C	-30° to +200°C	-40° to +200°C	-30° to +200°C	-30° to +200°C	-25° to +135°C
Cooling Capacity @ 20°C	200 W	200 W	505 W	915 W	1000 W	915 W	915 W	1400 W
Heater	1100 W (60 Hz)/2200 W (50 Hz)							2200 W (50/60 Hz)
Part Number 120 VAC/60 Hz	AD7LR-20-A11B	AD07R-20-A11B	AD07R-40-A11B	AD15R-30-A11B	AD15R-40-A11B	AD20R-30-A11B	AD28R-30-A11B	AD45R-20-A13D
Part Number 240 VAC/50 Hz	AD7LR-20-A12E	AD07R-20-A12E	AD07R-40-A12E	AD15R-30-A12E	AD15R-40-A12E	AD20R-30-A12E	AD28R-30-A12E	AD45R-20-A12E

1. 45 liter bath is 208-240 VAC, 50/60 Hz

Electrical plugs for the part numbers listed are standard U.S. and European types. See page 128 for additional plug types and part numbers.

# Standard Digital Temperature Controller

## Key Specifications

Working Temperature: From -30° to +170°C

Temperature Stability:  $\pm 0.04^\circ\text{C}$

Maximum Pressure: psi (bar)

120 VAC/60 Hz Models 3.5 (0.24)

240 VAC/50 Hz Models 2.9 (0.2)

Maximum Flow Rate: Pressure

gpm (l/min)

120 VAC/60 Hz Models 2.9 (11.0)

240 VAC/50 Hz Models 2.7 (10.2)



## Features:

- Intuitive 3.75" (9.5 cm) display with touch-pad control
- 2-speed pressure pump with external (closed-loop) circulation capability
- Swivel 180™, LidDock™, DuraTop™, WhisperCool™, Cool Command™
- On-board connectivity: RS232
- Automatic performance optimization
- Single-point calibration
- Complies with DIN 12876-1 Class I safety requirements for use with non-flammable liquids



Highly intuitive operator interface makes changing set-point and other operating parameters quick and simple.



Easy-to-use calibration function allows you to adjust the temperature display to match that of a traceable temperature standard.

For additional information on the Standard Digital Controller's features and capabilities, see pages 24 and 25.



**7-Liter: -20°C, Low-Profile**

**7-Liter: -20°C**

Temperature Range: -20° to +170°C

Temperature Range: -20° to +170°C

Working Access (L x W x D):  
6.18 x 5.59 x 5"  
15.7 x 14.2 x 12.7 cm

Working Access (L x W x D):  
6.18 x 5.59 x 5"  
15.7 x 14.2 x 12.7 cm

Overall Dimensions (L x W x H):  
23.2 x 16.2 x 16.2"  
58.9 x 41.1 x 41.1 cm

Overall Dimensions (L x W x H):  
21.3 x 8.7 x 24.3"  
54.1 x 22.1 x 61.7 cm



**15-Liter: -30°C**

**20-Liter: -30°C**

**28-Liter: -30°C**

Temperature Range: -30° to +170°C

Temperature Range: -30° to +170°C

Temperature Range: -30° to +170°C

Working Access (L x W x D):  
8.35 x 10.88 x 5.5"  
21.2 x 27.6 x 14 cm

Working Access (L x W x D):  
9.85 x 12.45 x 5.5"  
25 x 31.6 x 14 cm

Working Access (L x W x D):  
12.35 x 14.13 x 5.5"  
31.4 x 35.9 x 14 cm

Overall Dimensions (L x W x H):  
22.4 x 14.5 x 26.9"  
56.9 x 36.8 x 68.3 cm

Overall Dimensions (L x W x H):  
24 x 16.6 x 26.9"  
61 x 41.9 x 68.3 cm

Overall Dimensions (L x W x H):  
26.5 x 18 x 26.9"  
67.2 x 45.7 x 68.3 cm



Reservoir Size	7 Liter Low-Profile	7 Liter	15 Liter	20 Liter	28 Liter
Temperature Range	-20° to +170°C	-20° to +170°C	-30° to +170°C	-30° to +170°C	-30° to +170°C
Cooling Capacity @ 20°C	200 W		915 W		
Heater	1100 W (60 Hz)/2200 W (50 Hz)				
Part Number 120 VAC/60 Hz	SD7LR-20-A11B	SD07R-20-A11B	SD15R-30-A11B	SD20R-30-A11B	SD28R-30-A11B
Part Number 240 VAC/50 Hz	SD7LR-20-A12E	SD07R-20-A12E	SD15R-30-A12E	SD20R-30-A12E	SD28R-30-A12E

Electrical plugs for the part numbers listed are standard U.S. and European types. See page 128 for additional plug types and part numbers.

# MX Temperature Controller

## Key Specifications

Working Temperature: From -30° to +135°C

Temperature Stability:  $\pm 0.07^\circ\text{C}$

Maximum Pressure: psi (bar)

120 VAC/60 Hz Models 1.8 (0.12)

240 VAC/50 Hz Models 1.5 (0.10)

Maximum Flow Rate: Pressure

gpm (l/min)

120 VAC/60 Hz Models 3.4 (12.8)

240 VAC/50 Hz Models 2.8 (10.6)



## Features:

- Large, 3.25" (8.3 cm) universal icon and English display
- Single-speed pressure pump with external (closed-loop) circulation capability
- LidDock™, DuraTop™, WhisperCool™, Cool Command™
- User-adjustable high and low temperature limits and alarms
- Single-point calibration
- Complies with DIN 12876-1 Class I safety requirements for use with non-flammable liquids



Visual alarms alert you when bath temperature falls outside your pre-set limits.



Single-speed pressure pump provides external closed-loop circulation capability.

For additional information on the MX Controller's features and capabilities, see pages 26 and 27.



**7-Liter: -20°C, Low-Profile**

Temperature Range:  
-20° to +135°C

Working Access (L x W x D):  
6.18 x 5.59 x 5"  
15.7 x 14.2 x 12.7 cm

Overall Dimensions (L x W x H):  
23.2 x 16.2 x 17.3"  
58.9 x 41.1 x 43.9 cm

**7-Liter: -20°C**

Temperature Range:  
-20° to +135°C

Working Access (L x W x D):  
6.18 x 5.59 x 5"  
15.7 x 14.2 x 12.7 cm

Overall Dimensions (L x W x H):  
21.3 x 8.7 x 25.4"  
54.1 x 22.1 x 64.5 cm

**15-Liter: -30°C**

Temperature Range:  
-30° to +135°C

Working Access (L x W x D):  
8.35 x 10.88 x 5.5"  
21.2 x 27.6 x 14 cm

Overall Dimensions (L x W x H):  
22.4 x 14.5 x 28"  
56.9 x 36.8 x 71.1 cm

**20-Liter: -30°C**

Temperature Range:  
-30° to +135°C

Working Access (L x W x D):  
9.85 x 12.45 x 5.5"  
25 x 31.6 x 14 cm

Overall Dimensions (L x W x H):  
24 x 16.5 x 28"  
61 x 41.9 x 71.1 cm



Reservoir Size	7 Liter Low-Profile	7 Liter	15 Liter	20 Liter
Temperature Range	-20° to 135°C	-20° to 135°C	-30° to 135°C	-30° to 135°C
Cooling Capacity @ 20°C	200 W		915 W	
Heater	1100 W			
Part Number 120 VAC/60 Hz	MX7LR-20-A11B	MX07R-20-A11B	MX15R-30-A11B	MX20R-30-A11B
Part Number 240 VAC/50 Hz	MX7LR-20-A12E	MX07R-20-A12E	MX15R-30-A12E	MX20R-30-A12E

Electrical plugs for the part numbers listed are standard U.S. and European types. See page 128 for additional plug types and part numbers.

# Heated Circulating Baths

Heated Circulating Baths, Open Tank Systems, and Immersion Circulators. If it needs heat, it needs PolyScience.

#### Features:

- Working temperatures from ambient +10°C to +200°C
- Temperature stabilities to  $\pm 0.005^\circ\text{C}$
- Capacities from 6 to 28 liters
- Six controller types with large, intuitive displays and multiple communication options
- Large bath openings and easy to clean surfaces
- Swivel 180™ Rotating Controllers
- LidDock™ lid stowing system
- DuraTop™ chemical resistant deck



PolyScience offers almost 50 different solutions for your laboratory's liquid-heating needs – from a simple immersion circulator to economical open bath systems to full-featured circulating baths with ramp and soak capability. Typical applications include warming reagents and culture media, thawing or tempering samples, biological incubation, cell culture, enzyme assays, or controlling the temperature of laboratory equipment such as chromatography columns, viscometers, and densitometers.

PolyScience Heated Circulators come with the following accessories:

- Reservoir cover
- Bypass tubing
- Male inlet and outlet adapters for 3/8, 1/4, and 3/16" (.95, .63, and .47 cm) tubing. 1/4" NPT to M16 adapters also included on 50 Hz units.

Also included is a 6' (1.83 m) standard grounded electrical cord with country-specific plug.





## Features:

- Intuitive**  
 Whether equipped with the entry-level MX Controller or the most sophisticated Performance Programmable, our Heated Circulating Baths are extremely easy to use. Crisp menu architecture, screen icons, and plain-text prompts make it easy to navigate through operational settings and options.
- Convenient**  
 LidDock™ helps keep moisture where it belongs – in the bath. And accessing the reservoir drain is as simple as removing the Circulator's front panel.
- Safe**  
 All models feature user-settable high-temperature safeties as well as redundant over-temperature protection and comply with RoHS, WEEE, IEC 61010-1, IEC 61010-2-010, IEC 61326-1, DIN 12876 and are CE and ETL certified. Our DuraTop™ surface is cooler to the touch when operating at high temperatures.
- Precise**  
 Exceptionally exacting temperature control, combined with a tap-water cooling-coil, allow you to maintain bath temperatures at or near ambient with stabilities as precise as  $\pm 0.005^{\circ}\text{C}$ .
- Versatile**  
 A variety of communication and control options, including Ethernet, USB data logging and computer control, bi-directional serial communication, and external circulation with remote temperature control, enhance functionality and applications flexibility.

# Heated Circulating Baths Selection Guide



Fully Integrated Heated Circulating Baths

Open Bath Systems

		Capacity	7 Liter	15 Liter	20 Liter	28 Liter	6 Liter	10 Liter
		Maximum Temperature <sup>1</sup>	200°C	200°C	200°C	200°C	150°C	150°C
		Minimum Temperature <sup>2</sup>	Ambient +10°C	Ambient +10°C	Ambient +10°C	Ambient +10°C	Ambient +10°C	Ambient +10°C
		Working Access (L x W x D)	6.18 x 5.59 x 5" 15.7 x 14.2 x 12.7 cm	8.35 x 10.88 x 5.5" 21.2 x 27.6 x 14 cm	9.85 x 12.45 x 5.5" 25 x 31.6 x 14 cm	12.35 x 14.13 x 5.5" 31.4 x 35.9 x 14 cm	3.9 x 4.3 x 6" 10 x 11 x 15.2 cm	3.9 x 10.1 x 6" 9.9 x 25.5 x 15.2 cm
		Tank Material	Insulated Stainless Steel	Insulated Stainless Steel	Insulated Stainless Steel	Insulated Stainless Steel	Stainless Steel	Stainless Steel
		Drain	•	•	•	•		
		Tap Water Cooling-Coil	•	•	•	•		
		LidDock™	•	•	•	•		
Catalog Number	Performance Programmable	120 VAC/60 Hz 240 VAC/50 Hz	PP07H200-A11B PP07H200-A12E	PP15H200-A11B PP15H200-A12E	PP20H200-A11B PP20H200-A12E	PP28H200-A11B PP28H200-A12E		
	Advanced Programmable	120 VAC/60 Hz 240 VAC/50 Hz	AP07H200-A11B AP07H200-A12E	AP15H200-A11B AP15H200-A12E	AP20H200-A11B AP20H200-A12E	AP28H200-A11B AP28H200-A12E	AP06S150-A11B AP06S150-A12E	AP10S150-A11B AP10S150-A12E
	Performance Digital	120 VAC/60 Hz 240 VAC/50 Hz	PD07H200-A11B PD07H200-A12E	PD15H200-A11B PD15H200-A12E	PD20H200-A11B PD20H200-A12E	PD28H200-A11B PD28H200-A12E		
	Advanced Digital	120 VAC/60 Hz 240 VAC/50 Hz	AD07H200-A11B AD07H200-A12E	AD15H200-A11B AD15H200-A12E	AD20H200-A11B AD20H200-A12E	AD28H200-A11B AD28H200-A12E	AD06S150-A11B AD06S150-A12E	AD10S150-A11B AD10S150-A12E
	Standard Digital	120 VAC/60 Hz 240 VAC/50 Hz	SD07H170-A11B SD07H170-A12E	SD15H170-A11B SD15H170-A12E	SD20H170-A11B SD20H170-A12E	SD28H170-A11B SD28H170-A12E		
	MX	120 VAC/60 Hz 240 VAC/50 Hz	MX07H135-A11B MX07H135-A12E	MX15H135-A11B MX15H135-A12E	MX20H135-A11B MX20H135-A12E		MX06S135-A11B MX06S135-A12E	MX10S135-A11B MX10S135-A12E

1. Maximum temperature is controller dependent for integrated systems (see Controller Selection Guide, pages 28 and 29); maximum temperature is dependent on tank material for Open Bath Systems with stainless steel or polycarbonate tanks. Immersion Circulator's maximum temperature is dependent on fluid volume.

2. Minimum temperature is shown with no external heat load.

Electrical plugs for the part numbers listed are standard U.S. and European types. See page 128 for additional plug types and part numbers.





Open Bath Systems

Immersion Circulator

20 Liter	28 Liter	8 Liter	11 Liter	14 Liter	17 Liter	23 Liter	28 Liter	Up to 28 Liters
150°C	150°C	85°C	85°C	85°C	85°C	85°C	85°C	135°C
Ambient +10°C	Ambient +10°C	Ambient +10°C	Ambient +10°C	Ambient +10°C	Ambient +10°C	Ambient +10°C	Ambient +10°C	Ambient +10°C
10.4 x 9 x 6" 26.4 x 22.8 x 15.2 cm	10.1 x 8.4 x 8" 25.7 x 21.4 x 20.3 cm	4.1 x 6.1 x 8" 10.5 x 15.6 x 20.3 cm	8.3 x 6.1 x 8" 21 x 15.6 x 20.3 cm	12.4 x 6.1 x 8" 31.4 x 15.6 x 20.3 cm	4.1 x 12 x 8" 10.5 x 30.5 x 20.3 cm	8.3 x 12 x 8" 21 x 30.5 x 20.3 cm	12.4 x 12 x 8" 31.5 x 30.5 x 20.3 cm	N/A
Stainless Steel	Stainless Steel	Polycarbonate	Polycarbonate	Polycarbonate	Polycarbonate	Polycarbonate	Polycarbonate	N/A
					•	•	•	
AP20S150-A11B AP20S150-A12E	AP28S150-A11B AP28S150-A12E	AP08P100-A11B AP08P100-A12E	AP11P100-A11B AP11P100-A12E	AP14P100-A11B AP14P100-A12E	AP17P100-A11B AP17P100-A12E	AP23P100-A11B AP23P100-A12E	AP28P100-A11B AP28P100-A12E	
AD20S150-A11B AD20S150-A12E	AD28S150-A11B AD28S150-A12E							
MX20S135-A11B MX20S135-A12E	MX28S135-A11B MX28S135-A12E	MX08P100-A11B MX08P100-A12E	MX11P100-A11B MX11P100-A12E	MX14P100-A11B MX14P100-A12E	MX17P100-A11B MX17P100-A12E	MX23P100-A11B MX23P100-A12E	MX28P100-A11B MX28P100-A12E	MX-CA11B MX-CA12E

# Performance Programmable Temperature Controller

## Key Specifications

Working Temperature: Up to 200°C

Temperature Stability:  $\pm 0.005^\circ\text{C}$

Maximum Pressure: psi (bar)

120 VAC/60 Hz Models 4.3 (0.3)

240 VAC/50 Hz Models 3.6 (0.25)

Maximum Flow Rate:	Pressure	Suction
	gpm (l/min)	gpm (l/min)
120 VAC/60 Hz Models	5.3 (20.1)	3.9 (14.7)
240 VAC/50 Hz Models	4.4 (16.7)	3.2 (12.2)



## Features:

- OpenMode time/temperature programming (no restriction on number of programs or steps)
- Intuitive 4.3" (10.9 cm) SmartTouch display
- 11 languages: French, German, Spanish, Chinese, Portuguese, Russian, Hindi, Arabic, Italian, Korean, English
- Variable-speed pressure/suction pump with external circulation and temperature control capability
- Swivel 180™, LidDock™, DuraTop™
- On-board connectivity: USB-A & B, Ethernet, RS232/485, remote on/off and external temperature probe
- Event scheduling (time & date) with real-time clock and temperature trends for up to 10 days
- Multiple, selectable "home" screens and on-screen help
- Automatic and/or user-adjustable performance optimization and 10-point calibration capability
- Complies with DIN 12876-1 Class III safety requirements for use with flammable liquids
- Available with DeviceNet™/CANbus, Modbus®, and Profibus® options
- Includes Enhanced Performance Hardware & Software Package



Powerful time/temperature programming function simplifies the creation of ramp and soak profiles or special test protocols. Programs can even be scheduled to run automatically at a predetermined time and date.

The Performance Programmable Controller's performance is easily fine-tuned by selecting a specific heat transfer fluid, entering a fluid's specific heat capacity value, or even adjusting PID settings.

For additional information on the Performance Programmable Controller's features and capabilities, see pages 16 and 17.



7-Liter: +200°C	15-Liter: +200°C	20-Liter: +200°C	28-Liter: +200°C
Temperature Range: Ambient +10° to +200°C	Temperature Range: Ambient +10° to +200°C	Temperature Range: Ambient +10° to +200°C	Temperature Range: Ambient +10° to +200°C
Working Access (L x W x D): 6.18 x 5.59 x 5" 15.7 x 14.2 x 12.7 cm	Working Access (L x W x D): 8.35 x 10.88 x 5.5" 21.2 x 27.6 x 14 cm	Working Access (L x W x D): 9.85 x 12.45 x 5.5" 25 x 31.6 x 14 cm	Working Access (L x W x D): 12.35 x 14.13 x 5.5" 31.4 x 35.9 x 14 cm
Overall Dimensions (L x W x H): 19.6 x 8.7 x 16.1" 49.9 x 22.1 x 40.9 cm	Overall Dimensions (L x W x H): 22.4 x 14.5 x 16.6" 56.9 x 36.8 x 42.2 cm	Overall Dimensions (L x W x H): 24 x 16.5 x 16.6" 61 x 41.9 x 42.2 cm	Overall Dimensions (L x W x H): 26.5 x 18 X 16.6" 67.2 x 45.7 x 42.2 cm

Reservoir Size	7 Liter	15 Liter	20 Liter	28 Liter
Temperature Range	Ambient +10° to +200°C			
Heater	1100 W (60 Hz)/2200 W (50 Hz)			
Part Number 120 VAC/60 Hz	PP07H200-A11B	PP15H200-A11B	PP20H200-A11B	PP28H200-A11B
Part Number 240 VAC/50 Hz	PP07H200-A12E	PP15H200-A12E	PP20H200-A12E	PP28H200-A12E

Electrical plugs for the part numbers listed are standard U.S. and European types. See page 128 for additional plug types and part numbers.

# Advanced Programmable Temperature Controller

## Key Specifications

Working Temperature: Up to 200°C

Temperature Stability:  $\pm 0.01^\circ\text{C}$

Maximum Pressure: psi (bar)

120 VAC/60 Hz Models 4.3 (0.3)

240 VAC/50 Hz Models 3.6 (0.25)

Maximum Flow Rate:	Pressure	Suction
	gpm (l/min)	gpm (l/min)
120 VAC/60 Hz Models	5.3 (20.1)	3.9 (14.7)
240 VAC/50 Hz Models	4.4 (16.7)	3.2 (12.2)



## Features:

- Time/temperature programming (ten 100-step programs)
- Intuitive 4.3" (10.9 cm) SmartTouch display
- 6 languages: French, German, Spanish, Chinese, Arabic, English
- Variable-speed pressure/suction pump with external circulation and temperature control capability
- Swivel 180™, LidDock™, DuraTop™
- On-board connectivity: USB-A & B, RS232/485, Ethernet and external temperature probe
- Event scheduling (time & date), real-time clock and temperature trends for up to 10 days
- Selectable "home" screens and on-screen help
- Automatic and/or user-adjustable performance optimization
- 5-point calibration capability
- Complies with DIN 12876-1 Class III safety requirements for use with flammable liquids

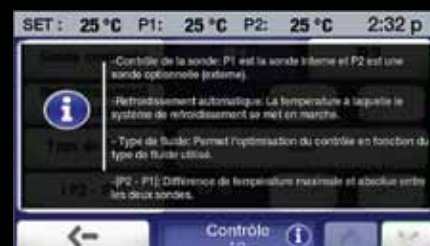

Multiple connectivity options give you a variety of ways to log data and control circulator operation.

All screens and menus, including on-line help, can be displayed in any of six different languages: English, French, German, Spanish, Chinese, or Arabic.

For additional information on the Advanced Programmable Controller's features and capabilities, see pages 18 and 19.



7-Liter: +200°C	15-Liter: +200°C	20-Liter: +200°C	28-Liter: +200°C
Temperature Range: Ambient +10° to +200°C	Temperature Range: Ambient +10° to +200°C	Temperature Range: Ambient +10° to +200°C	Temperature Range: Ambient +10° to +200°C
Working Access (L x W x D): 6.18 x 5.59 x 5" 15.7 x 14.2 x 12.7 cm	Working Access (L x W x D): 8.35 x 10.88 x 5.5" 21.2 x 27.6 x 14 cm	Working Access (L x W x D): 9.85 x 12.45 x 5.5" 25 x 31.6 x 14 cm	Working Access (L x W x D): 12.35 x 14.13 x 5.5" 31.4 x 35.9 x 14 cm
Overall Dimensions (L x W x H): 19.6 x 8.7 x 16.1" 49.9 x 22.1 x 40.9 cm	Overall Dimensions (L x W x H): 22.4 x 14.5 x 16.6" 56.9 x 36.8 x 42.2 cm	Overall Dimensions (L x W x H): 24 x 16.5 x 16.6" 61 x 41.9 x 42.2 cm	Overall Dimensions (L x W x H): 26.5 x 18 X 16.6" 67.2 x 45.7 x 42.2 cm

Reservoir Size	7 Liter	15 Liter	20 Liter	28 Liter
Temperature Range	Ambient +10° to +200°C			
Heater	1100 W (60 Hz)/2200 W (50 Hz)			
Part Number 120 VAC/60 Hz	AP07H200-A11B	AP15H200-A11B	AP20H200-A11B	AP28H200-A11B
Part Number 240 VAC/50 Hz	AP07H200-A12E	AP15H200-A12E	AP20H200-A12E	AP28H200-A12E

Electrical plugs for the part numbers listed are standard U.S. and European types. See page 128 for additional plug types and part numbers.

# Performance Digital Temperature Controller

## Key Specifications

Working Temperature: Up to 200°C

Temperature Stability:  $\pm 0.005^{\circ}\text{C}$

Maximum Pressure: psi (bar)

120 VAC/60 Hz Models 4.3 (0.3)

240 VAC/50 Hz Models 3.6 (0.25)

Maximum Flow Rate:	Pressure	Suction
	gpm (l/min)	gpm (l/min)
120 VAC/60 Hz Models	5.3 (20.1)	3.9 (14.7)
240 VAC/50 Hz Models	4.4 (16.7)	3.2 (12.2)



## Features:

- Intuitive 4.3" (10.9 cm) SmartTouch display
- 11 languages: French, German, Spanish, Chinese, Portuguese, Russian, Hindi, Arabic, Italian, Korean, English
- Variable-speed pressure/suction pump with external circulation and temperature control capability
- Swivel 180™, LidDock™, DuraTop™
- On-board connectivity: USB-A & B, Ethernet, RS232/485, remote on/off and external temperature probe
- Event scheduling (time & date) with real-time clock and temperature trends for up to 10 days
- Multiple, selectable "home" screens and on-screen help
- Automatic and/or user-adjustable performance optimization and 10-point calibration capability
- Complies with DIN 12876-1 Class III safety requirements for use with flammable liquids
- Includes Enhanced Performance Hardware & Software Package
- Available with DeviceNet™/CANbus, Modbus®, and Profibus® options



External temperature probe control compensates for heat loss, keeping external devices at the precise temperature required.



Making a temperature set-point change is fast and easy – whether it's a half of degree or a hundred.



For additional information on the Performance Digital Controller's features and capabilities, see pages 20 and 21.



7-Liter: +200°C	15-Liter: +200°C	20-Liter: +200°C	28-Liter: +200°C
Temperature Range: Ambient +10° to +200°C	Temperature Range: Ambient +10° to +200°C	Temperature Range: Ambient +10° to +200°C	Temperature Range: Ambient +10° to +200°C
Working Access (L x W x D): 6.18 x 5.59 x 5" 15.7 x 14.2 x 12.7 cm	Working Access (L x W x D): 8.35 x 10.88 x 5.5" 21.2 x 27.6 x 14 cm	Working Access (L x W x D): 9.85 x 12.45 x 5.5" 25 x 31.6 x 14 cm	Working Access (L x W x D): 12.35 x 14.13 x 5.5" 31.4 x 35.9 x 14 cm
Overall Dimensions (L x W x H): 19.6 x 8.7 x 16.1" 49.9 x 22.1 x 40.9 cm	Overall Dimensions (L x W x H): 22.4 x 14.5 x 16.6" 56.9 x 36.8 x 42.2 cm	Overall Dimensions (L x W x H): 24 x 16.5 x 16.6" 61 x 41.9 x 42.2 cm	Overall Dimensions (L x W x H): 26.5 x 18 X 16.6" 67.2 x 45.7 x 42.2 cm

Reservoir Size	7 Liter	15 Liter	20 Liter	28 Liter
Temperature Range	Ambient +10° to +200°C			
Heater	1100 W (60 Hz)/2200 W (50 Hz)			
Part Number 120 VAC/60 Hz	PD07H200-A11B	PD15H200-A11B	PD20H200-A11B	PD28H200-A11B
Part Number 240 VAC/50 Hz	PD07H200-A12E	PD15H200-A12E	PD20H200-A12E	PD28H200-A12E

Electrical plugs for the part numbers listed are standard U.S. and European types. See page 128 for additional plug types and part numbers.

# Advanced Digital Temperature Controller

## Key Specifications

Working Temperature: Up to 200°C

Temperature Stability:  $\pm 0.01^\circ\text{C}$

Maximum Pressure: psi (bar)

120 VAC/60 Hz Models 4.3 (0.3)

240 VAC/50 Hz Models 3.6 (0.25)

Maximum Flow Rate: Pressure Suction

gpm (l/min) gpm (l/min)

120 VAC/60 Hz Models 5.3 (20.1) 3.9 (14.7)

240 VAC/50 Hz Models 4.4 (16.7) 3.2 (12.2)



## Features:

- Intuitive 3.75" (9.5 cm) display with touch-pad control
- 4 languages: French, German, Spanish, English
- Variable-speed pressure/suction pump with external circulation and temperature control capability
- Swivel 180™, LidDock™, DuraTop™
- On-board connectivity: USB-A & B, RS232/485, Ethernet and external temperature probe
- Automatic and/or user-adjustable performance optimization
- Single-point calibration
- Complies with DIN 12876-1 Class III safety requirements for use with flammable liquids



On-screen prompts – in English, French, Spanish, or German – guide you through setup and operation.



Class III safety features plus user-settable over-temperature safety and adjustable high and low temperature limits provide exceptional process and equipment protection.

For additional information on the Advanced Digital Controller's features and capabilities, see pages 22 and 23.





7-Liter: +200°C	15-Liter: +200°C	20-Liter: +200°C	28-Liter: +200°C
Temperature Range: Ambient +10° to +200°C	Temperature Range: Ambient +10° to +200°C	Temperature Range: Ambient +10° to +200°C	Temperature Range: Ambient +10° to +200°C
Working Access (L x W x D): 6.18 x 5.59 x 5" 15.7 x 14.2 x 12.7 cm	Working Access (L x W x D): 8.35 x 10.88 x 5.5" 21.2 x 27.6 x 14 cm	Working Access (L x W x D): 9.85 x 12.45 x 5.5" 25 x 31.6 x 14 cm	Working Access (L x W x D): 12.35 x 14.13 x 5.5" 31.4 x 35.9 x 14 cm
Overall Dimensions (L x W x H): 19.6 x 8.7 x 16.1" 49.9 x 22.1 x 40.9 cm	Overall Dimensions (L x W x H): 22.4 x 14.5 x 16.6" 56.9 x 36.8 x 42.2 cm	Overall Dimensions (L x W x H): 24 x 16.5 x 16.6" 61 x 41.9 x 42.2 cm	Overall Dimensions (L x W x H): 26.5 x 18 X 16.6" 67.2 x 45.7 x 42.2 cm

Reservoir Size	7 Liter	15 Liter	20 Liter	28 Liter
Temperature Range	Ambient +10° to +200°C			
Heater	1100 W (60 Hz)/2200 W (50 Hz)			
Part Number 120 VAC/60 Hz	AD07H200-A11B	AD15H200-A11B	AD20H200-A11B	AD28H200-A11B
Part Number 240 VAC/50 Hz	AD07H200-A12E	AD15H200-A12E	AD20H200-A12E	AD28H200-A12E

Electrical plugs for the part numbers listed are standard U.S. and European types. See page 128 for additional plug types and part numbers.

# Standard Digital Temperature Controller

## Key Specifications

Working Temperature: Up to 170°C

Temperature Stability:  $\pm 0.04^\circ\text{C}$

Maximum Pressure: psi (bar)

120 VAC/60 Hz Models 3.5 (0.24)

240 VAC/50 Hz Models 2.9 (0.2)

Maximum Flow Rate: Pressure

gpm (l/min)

120 VAC/60 Hz Models 2.9 (11.0)

240 VAC/50 Hz Models 2.7 (10.2)



## Features:

- Intuitive 3.75" (9.5 cm) display with touch-pad control
- 2-speed pressure pump with external (closed-loop) circulation capability
- Swivel 180™, LidDock™, DuraTop™
- On-board connectivity: RS232
- Automatic performance optimization
- Single-point calibration
- Complies with DIN 12876-1 Class I safety requirements for use with non-flammable liquids



Easy-to-use calibration function allows you to adjust the temperature display to match that of a traceable temperature standard.



Highly intuitive operator interface makes changing the temperature set-point or making other operational adjustments simple and straightforward.

For additional information on the Standard Digital Controller's features and capabilities, see pages 24 and 25.



7-Liter: +170°C	15-Liter: +170°C	20-Liter: +170°C	28-Liter: +170°C
Temperature Range: Ambient +10° to +170°C	Temperature Range: Ambient +10° to +170°C	Temperature Range: Ambient +10° to +170°C	Temperature Range: Ambient +10° to +170°C
Working Access (L x W x D): 6.18 x 5.59 x 5" 15.7 x 14.2 x 12.7 cm	Working Access (L x W x D): 8.35 x 10.88 x 5.5" 21.2 x 27.6 x 14 cm	Working Access (L x W x D): 9.85 x 12.45 x 5.5" 25 x 31.6 x 14 cm	Working Access (L x W x D): 12.35 x 14.13 x 5.5" 31.4 x 35.9 x 14 cm
Overall Dimensions (L x W x H): 19.6 x 8.7 x 16.1" 49.9 x 22.1 x 40.9 cm	Overall Dimensions (L x W x H): 22.4 x 14.5 x 16.6" 56.9 x 36.8 x 42.2 cm	Overall Dimensions (L x W x H): 24 x 16.5 x 16.6" 61 x 41.9 x 42.2 cm	Overall Dimensions (L x W x H): 26.5 x 18 X 16.6" 67.2 x 45.7 x 42.2 cm

Reservoir Size	7 Liter	15 Liter	20 Liter	28 Liter
Temperature Range	Ambient +10° to +170°C			
Heater	1100 W (60 Hz)/2200 W (50 Hz)			
Part Number 120 VAC/60 Hz	SD07H170-A11B	SD15H170-A11B	SD20H170-A11B	SD28H170-A11B
Part Number 240 VAC/50 Hz	SD07H170-A12E	SD15H170-A12E	SD20H170-A12E	SD28H170-A12E

Electrical plugs for the part numbers listed are standard U.S. and European types. See page 128 for additional plug types and part numbers.

# MX Temperature Controller

## Key Specifications

Working Temperature: Up to 135°C

Temperature Stability:  $\pm 0.07^\circ\text{C}$

Maximum Pressure: psi (bar)

120 VAC/60 Hz Models 1.8 (0.12)

240 VAC/50 Hz Models 1.5 (0.10)

Maximum Flow Rate: Pressure

gpm (l/min)

120 VAC/60 Hz Models 3.4 (12.8)

240 VAC/50 Hz Models 2.8 (10.6)



## Features:

- Large, 3.25" (8.3 cm) universal icon and English display
- Single-speed pressure pump with external (closed-loop) circulation capability
- LidDock™, DuraTop™
- User-adjustable high and low temperature limits and alarms
- Single-point calibration
- Complies with DIN 12876-1 Class I safety requirements for use with non-flammable liquids



Visual alarms alert you when bath temperature falls outside your pre-set limits.



Easy-to-use calibration function makes it simple to adjust the temperature display to match that of a traceable temperature standard.

For additional information on the MX Controller's features and capabilities, see pages 26 and 27.



**7-Liter: +135°C**

Temperature Range:  
Ambient +10° to +135°C

Working Access (L x W x D):  
6.18 x 5.59 x 5"  
15.7 x 14.2 x 12.7 cm

Overall Dimensions (L x W x H):  
19.6 x 8.7 x 17.2"  
49.9 x 22.1 x 43.7 cm

**15-Liter: +135°C**

Temperature Range:  
Ambient +10° to +135°C

Working Access (L x W x D):  
8.35 x 10.88 x 5.5"  
21.2 x 27.6 x 14 cm

Overall Dimensions (L x W x H):  
22.4 x 14.5 x 17.8"  
56.9 x 36.8 x 45.2 cm

**20-Liter: +135°C**

Temperature Range:  
Ambient +10° to +135°C

Working Access (L x W x D):  
9.85 x 12.45 x 5.5"  
25 x 31.6 x 14 cm

Overall Dimensions (L x W x H):  
24 x 16.5 x 17.8"  
61 x 41.9 x 45.2 cm

Reservoir Size	7 Liter	15 Liter	20 Liter
Temperature Range	Ambient +10° to +135°C		
Heater	1100 W		
Part Number 120 VAC/60 Hz	MX07H135-A11B	MX15H135-A11B	MX20H135-A11B
Part Number 240 VAC/50 Hz	MX07H135-A12E	MX15H135-A12E	MX20H135-A12E

Electrical plugs for the part numbers listed are standard U.S. and European types. See page 128 for additional plug types and part numbers.

## Stainless Steel Open Bath Systems

Controller bridge rests securely on the deep drawn stainless steel reservoir, yet is easily removed for tank cleaning. Generous bath opening provides ready access to samples and included bath cover improves stability.



### Features:

- Working temperatures from ambient +10°C up to 150°C
- Advanced Programmable, Advanced Digital, or MX Temperature Controller
- 6, 10, 20, or 28 liter reservoir
- DuraTop™ Chemical Resistant Bridge, Swivel 180™ Rotating Controller (on Advanced Programmable and Advanced Digital models)
- Lidded opening for optional cooling coil (10, 20 and 28 liter models)
- External circulation capability
- Economical alternative to integrated heating baths
- Complies with DIN 12876-1 Class I safety requirements for use with non-flammable liquids
- Includes bath cover



Our Advanced Programmable Temperature Controller combines time/temperature programming, a large touch-screen display, USB and serial communication to deliver exceptional performance and flexibility.



Open Bath Systems with the Advanced Series Controller feature Swivel 180™ for easy viewing and flexible bath placement.

See pages 18 through 27 for Controller features and capabilities.



Reservoir Size		6 Liter	10 Liter	20 Liter	28 Liter
Maximum Temperature <sup>1</sup>		150°C	150°C	150°C	150°C
Working Access (L x W x D)		3.9 x 4.3 x 6" 10 x 11 x 15.2 cm	3.9 x 10.1 x 6" 9.9 x 25.5 x 15.2 cm	10.4 x 9 x 6" 26.4 x 22.8 x 15.2 cm	10.1 x 8.4 x 8" 25.7 x 21.4 x 20.3 cm
Overall Dimensions (L x W x H)		13.4 x 8.1 x 16" 34 x 20.6 x 40.6 cm	13.9 x 13.5 x 16" 35.3 x 34.2 x 40.6 cm	20.9 x 13.5 x 16" 53.1 x 34.2 x 40.6 cm	20.9 x 13.5 x 18" 53.1 x 34.2 x 45.7 cm
Advanced Programmable	120 VAC/60 Hz 240 VAC/50 Hz	APO6S150-A11B APO6S150-A12E	AP10S150-A11B AP10S150-A12E	AP20S150-A11B AP20S150-A12E	AP28S150-A11B AP28S150-A12E
Advanced Digital	120 VAC/60 Hz 240 VAC/50 Hz	ADO6S150-A11B ADO6S150-A12E	AD10S150-A11B AD10S150-A12E	AD20S150-A11B AD20S150-A12E	AD28S150-A11B AD28S150-A12E
MX	120 VAC/60 Hz 240 VAC/50 Hz	MX06S135-A11B MX06S135-A12E	MX10S135-A11B MX10S135-A12E	MX20S135-A11B MX20S135-A12E	MX28S135-A11B MX28S135-A12E

1. Stainless steel tank will handle temperatures up to 150°C; maximum temperature with MX controller is 135°C.

Includes Temperature Controller, bridge, stainless steel tank, and bath cover.

Electrical plugs for the part numbers listed are standard U.S. and European types. See page 128 for additional plug types and part numbers.

## Polycarbonate Open Bath Systems

Transparent polycarbonate reservoir lets you keep samples in clear view. Elevated tank bottom provides secure handholds when lifting or relocating bath and is stable on uneven surfaces. Controller bridge removes easily for tank cleaning, rests securely on reservoir top edge when in use.



### Features:

- Working temperatures from ambient +10°C up to 85°C
- Advanced Programmable or MX Temperature Controller
- 8, 11, 14, 17, 23, or 28 liter reservoir
- DuraTop™ chemical resistant bridge
- Lidded opening for optional cooling coil (17, 23 and 28 liter models)
- Drain port (17, 23 and 28 liter models)
- Complies with DIN 12876-1 Class I safety requirements for use with non-flammable liquids
- Includes bath cover



The compact and economical MX Temperature Controller is extremely simple to operate and maintains bath temperatures with  $\pm 0.07^\circ\text{C}$  stability.



The optional cooling coil is ideal for set-points near ambient temperature or when rapid cooling is required.

See pages 18-19 and 26-27 for Controller features and capabilities.





Reservoir Size		8 Liter	11 Liter	14 Liter	17 Liter	23 Liter	28 Liter
Maximum Temperature <sup>1</sup>		85°C	85°C	85°C	85°C	85°C	85°C
Working Access (L x W x D)		4.1 x 6.1 x 8" 10.5 x 15.6 x 20.3 cm	8.3 x 6.1 x 8" 21 x 15.6 x 20.3 cm	12.4 x 6.1 x 8" 31.4 x 15.6 x 20.3 cm	4.1 x 12 x 8" 10.5 x 30.5 x 20.3 cm	8.3 x 12 x 8" 21 x 30.5 x 20.3 cm	12.4 x 12 x 8" 31.5 x 30.5 x 20.3 cm
Overall Dimensions (L x W x H)		12.7 x 8.2 x 17.4" 32.2 x 20.8 x 44.1 cm	16.8 x 8.2 x 17.4" 42.7 x 20.8 x 44.1 cm	20.9 x 8.2 x 17.4" 53.2 x 20.8 x 44.1 cm	13.9 x 13.6 x 17.4" 35.3 x 34.5 x 44.1 cm	18 x 13.6 x 17.4" 45.7 x 34.5 x 44.1 cm	22.1 x 13.6 x 17.4" 56.2 x 34.5 x 44.1 cm
Advanced Programmable	120 VAC/60 Hz 240 VAC/50 Hz	AP08P100-A11B AP08P100-A12E	AP11P100-A11B AP11P100-A12E	AP14P100-A11B AP14P100-A12E	AP17P100-A11B AP17P100-A12E	AP23P100-A11B AP23P100-A12E	AP28P100-A11B AP28P100-A12E
MX	120 VAC/60 Hz 240 VAC/50 Hz	MX08P100-A11B MX08P100-A12E	MX11P100-A11B MX11P100-A12E	MX14P100-A11B MX14P100-A12E	MX17P100-A11B MX17P100-A12E	MX23P100-A11B MX23P100-A12E	MX28P100-A11B MX28P100-A12E

1. Maximum recommended operating temperature for polycarbonate tank; Temperature Controllers capable of higher temperatures. Includes Temperature Controller, bridge, tank, and bath cover. Electrical plugs for the part numbers listed are standard U.S. and European types. See page 128 for additional plug types and part numbers.

# MX Immersion Circulator

## Key Specifications

Working Temperature: Up to 135°C

Temperature Stability:  $\pm 0.07^\circ\text{C}$

Heater: 1100 W

Maximum Pressure: psi (bar)

120 VAC/60 Hz Models 1.8 (0.12)

240 VAC/50 Hz Models 1.5 (0.10)

Maximum Flow Rate: Pressure

gpm (l/min)

120 VAC/60 Hz Models 3.4 (12.8)

240 VAC/50 Hz Models 2.8 (10.6)

## Part Number:

120 VAC/60 Hz)

**MX-CA11B**

240 VAC/50 Hz)

**MX-CA12E**



## Features:

- Create a circulating bath using your own vessel or a PolyScience open bath tank
- Large, 3.25" (8.3 cm) universal icon and English display
- Single-speed pressure pump
- Adjustable flow
- User-adjustable high and low temperature limits and alarms
- Integral pump and heater coil protection
- Complies with DIN 12876-1 Class I safety requirements for use with non-flammable liquids
- Single-point calibration

## Build Your Own Refrigerated Circulator

Create an economical refrigerated circulator by combining an MX Immersion Circulator with our 13 Liter Refrigerated Open Bath (page 75).

The MX Immersion Circulator should be mounted only to tanks with a working depth of 7.25"/18.4 cm or more.



Convenient slide control allows you to easily adjust the flow rate.

Clamps securely to both straight and curved tank walls.

Electrical plugs for the part numbers listed are standard U.S. and European types. See page 128 for additional plug types and part numbers. For additional information on the MX Immersion Circulator's features and capabilities, see pages 26 and 27.

# Open Tanks

## Stainless Steel Open Tanks

### Features:

- Liquid temperatures up to 150°C
- One-piece deep drawn stainless steel
- Rounded internal corners for easy cleaning



Stainless Steel	Temperature Limit 150°C	
Reservoir Size	13 Liter	28 Liter
Working Access (L x W x D)	9 x 6.5 x 8" (22.9 x 16.5 x 20.3 cm)	16.5 x 8.5 x 8" (41.9 x 21.6 x 20.3 cm)
Dimensions (L x W x H)	12.63 x 10.38 x 9.62" (32.1 x 28.9 x 24.4 cm)	20.87 x 12.87 x 9.62" (53 x 32.7 x 24.4 cm)
Part Number	T13SA1	T28SA1

## Polycarbonate Open Tanks

### Features:

- Liquid temperatures up to 85°C
- Drain port (17, 23, and 28 liter models)
- Elevated tank bottom with secure handholds



Polycarbonate	Temperature Limit 85°C					
Reservoir Size	8 Liter	11 Liter	14 Liter	17 Liter	23 Liter	28 Liter
Working Access (L x W x D)	11.2 x 6.13 x 8" 28.4 x 15.6 x 20.3 cm	15.3 x 6.13 x 8" 38.9 x 15.6 x 20.3 cm	19.4 x 6.13 x 8" 49.3 x 15.6 x 20.3 cm	12.3 x 12 x 8" 31.2 x 30.5 x 20.3 cm	16.4 x 12 x 8" 41.7 x 30.5 x 20.3 cm	20.6 x 12 x 8" 52.3 x 30.5 x 20.3 cm
Overall Dimensions (L x W x H)	11.9 x 6.87 x 9.13" 30.2 x 17.4 x 23.2 cm	16 x 6.87 x 9.13" 40.6 x 17.4 x 23.2 cm	20.2 x 6.87 x 9.13" 51.3 x 17.4 x 23.2 cm	13.8 x 12.75 x 9.13" 35.1 x 32.4 x 23.2 cm	17.9 x 12.75 x 9.13" 45.5 x 32.4 x 23.2 cm	21.1 x 12.75 x 9.13" 56.1 x 32.4 x 23.2 cm
Part Number	T08PA1	T11PA1	T14PA1	T17PA1	T23PA1	T28PA1

## Model 210 Heated Recirculator

### Key Specifications

Working Temperature: Ambient to +70°C  
 Temperature Stability: ±0.2°C  
 Heater: 750 W  
 Pump: Single-speed, Centrifugal  
 Maximum Pressure: 2 psi (0.13 bar)  
 Maximum Flow Rate: 3.0 gpm (11.4 l/min)

### Features:

- Low-cost pumping and heating for closed-loop applications
- Provides accurate control within a frequently used temperature range
- Ideal for applications such as thawing plasma, tempering photographic solutions, or circulating to an external device



Part Number (120 VAC/50/60 Hz): 040300  
 Part Number (240 VAC/50/60 Hz): 040301

## Specialty Products

PolyScience specialty products are uniquely configured to accommodate specific testing and quality control needs, such as the calibration of temperature measurement devices, viscosity measurements, fecal coliform testing, plasma-thawing, histological and beverage-aging studies.



- 
- 70-71 Viscosity Baths
  - 72-73 Calibration Baths
  - 74 75 Liter Refrigerated Circulating Bath
  - 75 Cryoprecipitate Bath
  - 76 Histology Bath and Histology Freeze Plate
  - 77 Coliform Bath
  - 78-83 Refrigerated and Heated Circulator and Specialty Product Accessories
-



## Viscosity Baths

PolyScience Viscosity Baths are uniquely configured to accommodate specific testing and quality control needs, including ASTM D-445. Both round and square top opening configurations are available.



### Features:

- Working temperatures up to 135°C
- Temperature stabilities to  $\pm 0.01^\circ\text{C}$
- Advanced Programmable, Advanced Digital, Standard Digital, or MX Temperature Controller
- Configured for use with popular capillary viscometers
- Choice of glass or polycarbonate reservoir
- Includes tap water cooling coil
- Lidded viscometer openings



For additional information on Advanced Programmable, Advanced Digital, Standard Digital, and MX Temperature Controllers, see pages 18 through 27.

## Polycarbonate Viscosity Baths

Temperature Controller	Advanced Programmable		Advanced Digital		Standard Digital	
Programmable For Test Protocols	Yes		No		No	
Reservoir Capacity	29 liters					
Maximum Temperature <sup>1</sup>	85°C					
Temperature Stability	±0.01°C		±0.01°C		±0.04°C	
Heater	1100 W (60 Hz)/2200 W (50 Hz)					
Viscometer Openings	5 Round	3 Square	5 Round	3 Square	5 Round	3 Square
Working Depth	11.25"/28.6 cm					
Pump	Variable-speed		Variable-speed		2-Speed	
Overall Dimensions (L X W x H)	21.4 X 9 x 20.7"/54.4 x 22.9 x 52.6 cm					
Part Number 120 VAC/60 Hz	AP29VB5R-A11B	AP29VB3S-A11B	AD29VB5R-A11B	AD29VB3S-A11B	SD29VB5R-A11B	SD29VB3S-A11B
Part Number 240 VAC/50 Hz	AP29VB5R-A12E	AP29VB3S-A12E	AD29VB5R-A12E	AD29VB3S-A12E	SD29VB5R-A12E	SD29VB3S-A12E

1. Maximum temperature dependent on tank material; Temperature Controllers capable of higher temperatures.

## Glass Viscosity Baths

Temperature Controller	MX	
Reservoir Capacity	17 liters	27 liters
Maximum Temperature	135°C	
Temperature Stability	±0.07°C	
Heater	1100 W (50/60 Hz)	
Viscometer Openings	6 Round	
Working Depth	11"/27.9 cm	17"/ 43.2 cm
Pump	1-Speed	
Overall Dimensions	12.5 Ø x 20.5"/31.8 Ø x 52.1 cm	12.5 Ø x 26.4"/31.8 Ø x 67 cm
Part Number 120 VAC/60 Hz	MX17VB6G-A11B	
Part Number 240 VAC/50 Hz	MX17VB6G-A12E	

Electrical plugs for the part numbers listed are standard U.S. and European types. See page 128 for additional plug types and part numbers.

# Calibration Baths

## Key Specifications

Calibration Temperatures:	From -30° to +200°C
Temperature Stability:	±0.005°C
Calibration Certificate:	2-point factory calibration
Reservoir Capacity:	15 liters



## Features:

- Accommodates up to 6 temperature measuring devices
- Choice of Performance Programmable Temperature Controller with OpenMode time/temperature programming or Performance Digital Temperature Controller
- Intuitive 4.3" (10.9 cm) SmartTouch display
- Swivel 180™, LidDock™, DuraTop™, WhisperCool™, Cool Command™
- 11 languages: French, German, Spanish, Chinese, Portugese, Russian, Hindi, Arabic, Italian, Korean, English
- On-board connectivity: USB-A & B, Ethernet, RS232/485, remote on/off, and external temperature probe
- Event scheduling (time & date), real-time clock and temperature trends for up to 10 days
- Automatic and/or user-adjustable performance optimization and 10-point calibration capability
- Complies with DIN 12876-1 Class III safety requirements for use with flammable liquids
- Includes Enhanced Performance Hardware & Software Package
- Bath lid with sleeves for two each 3 mm, 4 mm, and 6 mm diameter openings

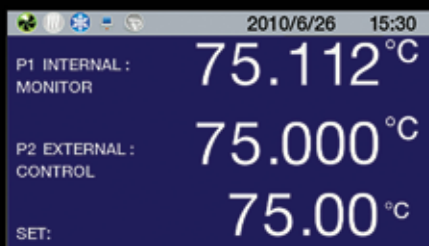

Displays calibration temperatures to 1/1000 degree C.



Accommodates thermometers and temperature sensors from 2 to 8 mm in diameter. See page 79 for available Sleeve Kits.



For additional information on Performance Programmable and Performance Digital Temperature Controller features and capabilities, see pages 16-17 and 20-21.



## Heating Only Calibration Baths

Temperature Controller	Performance Programmable	Performance Digital
Programmable For Specific Test Protocols	Yes	No
Calibration Temperatures	Ambient +10° to +200°C	
Temperature Stability	±0.005°C	
Heater	1100 W (60Hz)/2200 W (50Hz)	
Pump	Variable-speed	
Reservoir Volume	15 liters	
Bath Opening/Working Depth	4.6 Ø x 11"/11.8 Ø x 28 cm	
Overall Dimensions (L X W x H)	21.3 x 8.7 x 24.3"/54.1 x 22.1 x 61.7 cm	
Part Number 120 VAC/60 Hz	PP15HCAL-A11B	PD15HCAL-A11B
Part Number 240 VAC/50 Hz	PP15HCAL-A12E	PD15HCAL-A12E

## Refrigerated /Heated Calibration Baths

Temperature Controller	Performance Programmable	Performance Digital
Programmable For Specific Test Protocols	Yes	No
Calibration Temperatures	-30° to +200°C	
Cooling Capacity @ 20°C	505 W	
Temperature Stability	±0.005°C	
Heater	1100 W (60Hz)/2200 W (50Hz)	
Pump	Variable-speed	
Reservoir Volume	15 liters	
Bath Opening/Working Depth	4.6 Ø x 11"/11.7 Ø x 28 cm	
Overall Dimensions (L X W x H)	21.3 x 8.7 x 30.5"/54.1 x 22.1 x 77.5 cm	
Part Number 120 VAC/60 Hz	PP15RCAL-A11B	PD15RCAL-A11B
Part Number 240 VAC/50 Hz	PP15RCAL-A12E	PD15RCAL-A12E

Electrical plugs for the part numbers listed are standard U.S. and European types. See page 128 for additional plug types and part numbers.

## Factory Calibration Services

PolyScience Calibration Baths are factory calibrated at 35° and 90°C. Additional calibration certificates are available:

1-Point Calibration: Part Number: 130-346

Additional Calibration Points: Part Number: 130-347

# 75 Liter Refrigerated Circulating Bath

## Key Specifications

Working Temperature:	-20° to +100°C	
Temperature Stability:	±0.005°C	
Cooling Capacity:	1400 W @ 20°C	
Working Access (L x W x D):	21.6 x 15.7 x 9.4" 54.9 x 39.8 x 23.9 cm	
Overall Dimensions (L x W x H):	35.8 x 22.4 x 42.1" 90.9 x 56.9 x 107 cm	
Maximum Pressure:	psi (bar)	
208-240 VAC/60 Hz Models	4.3 (0.3)	
208-240 VAC/50 Hz Models	3.6 (0.25)	
Maximum Flow Rate:	Pressure	Suction
	gpm (l/min)	gpm (l/min)
208-240 VAC/60 Hz Models	5.3 (20.1)	3.9 (14.7)
208-240 VAC/50 Hz Models	4.4 (16.7)	3.2 (12.2)

## Part Number:

208-240 VAC, 50/60Hz	<b>PP75R-20-A13D</b>
208-240 VAC, 50/60Hz	<b>PP75R-20-A12E</b>



## Features:

- Specifically designed to replicate temperature fluctuations that accelerate beverage aging
- Performance Programmable Temperature Controller allows endless array of thermal cycling options and programs
- Intuitive 4.3" (10.9 cm) SmartTouch display
- 11 languages: French, German, Spanish, Chinese, Portuguese, Russian, Hindi, Arabic, Italian, Korean, English
- Variable-speed pressure/suction pump with external circulation and temperature control capability
- Swivel 180™, DuraTop™, WhisperCool™, Cool Command™
- On-board connectivity: USB-A & B, Ethernet, RS232/485, remote on/off, external temperature probe
- Event scheduling (time & date), real-time clock and temperature trends for up to 10 days
- Multiple, selectable "home" screens and on-screen help
- Automatic and/or user-adjustable performance optimization and 10-point calibration capability
- Complies with DIN 12876-1 Class III safety requirements for use with flammable liquids
- Includes Enhanced Performance Hardware & Software Package



For more information on the Performance Programmable Temperature Controller, see pages 16 and 17. Electrical plugs for the part numbers listed are standard U.S. and European types. See page 128 for additional plug types and part numbers.

# Cryoprecipitate Bath

## Key Specifications

Working Temperature: Fixed at 4°C (other factory set temperatures available)

Temperature Stability: ±0.1°C

Reservoir Capacity: 52.24 liters

Working Access (L x W x D): 20.6 x 13 x 12"  
52.4 x 33 x 30.5 cm

Overall Dimensions (L x W x H): 28 x 14.5 x 36.6"  
71.1 x 37 x 93 cm

## Part Number:

120 VAC/60 Hz  
240 VAC/50 Hz

**6260B1CRY10C**  
**6250B2CRY30E**



## Features:

- Safe, reliable thawing of Fresh Frozen Plasma (FFP) for the recovery of Cryoprecipitated Antihemophilic Factor (AHF)
- Preset to a 4°C thawing temperature
- Thaws up to 24 units of FFP or Whole Blood (WB) simultaneously
- Bright temperature and elapsed time displays
- Built-in over-temperature and flow alarms
- Calibration capability
- High efficiency fluid filter, removable air filter, reservoir drain
- Removable, center-hinged reservoir cover



C 155859 US

Electrical plugs for the part numbers listed are standard U.S. and European types. See page 128 for additional plug types and part numbers.

## 13 Liter Refrigerated Open Bath

### Key Specifications

Working Temperature: 0° to 150°C

Cooling Capacity: Up to 400 watts at 20°C

Reservoir Capacity: 13 liters



### Features:

- Continuous cooling to 0°C
- Designed to run at maximum cooling; requires heated thermostat for temperature control
- Combine with the MX Immersion Circulator to create a refrigerated circulating bath
- Ideal for applications where bath temperatures at or below ambient are required
- Insulated stainless steel tank
- Cool Command™



Working Temperature	0° to 150°C	
Reservoir Size	13 Liter	
Tank	Stainless Steel	
Temperature Control	Continuous Cooling to 0°C	
Electrical Requirements	120 VAC, 60Hz	240 VAC, 50Hz
Cooling Capacity <sup>1</sup> @ 0°C (W)	400	330
	270	225
	90	75
Working Access (L x W x D)	9 x 11.75 x 7.75"/22.9 x 29.8 x 19.7 cm	
Overall Dimensions (L x W x H)	13.5 x 22 x 10"/34.3 x 55.9 x 25.4 cm	
Part Number	T13RSA11B	T13RSA12E

1. Cooling capacity based on ambient temperature of 20°C (68°F).

Electrical plugs for the part numbers listed are standard U.S. and European types. See page 128 for additional plug types and part numbers.

## Histology Bath

### Key Specifications

Working Temperature: Fixed at -60°C/-76°F

Bath Work Area: 4.8 Ø x 6.6" deep  
12.2 Ø x 16.8 cm

Reservoir Capacity: 1.9 liters

Overall Dimensions (L x W x H): 22.75 x 11 x 11"  
57.8 x 27.9 x 27.9 cm

### Part Number:

120 VAC/60 Hz

240 VAC/50 Hz

**HBATH-60-A11B**

**HBATH-60-A12E**



## Features:

- Low working temperature freezes samples quickly, preventing microscopic ice crystals from developing and samples from distorting
- Ideal for fast-freezing tissue for enzyme studies
- 1.9 liter stainless steel reservoir with immersion basket and lid

Perforated stainless steel basket makes it easy to immerse and remove samples.

- Front-mounted reservoir drain
- DuraTop™
- Includes stainless steel immersion basket



## Histology Freeze Plate

### Key Specifications

Working Temperature: Fixed at -34.4°C/-30°F

Freezing Surface: 14.5 x 9.4"  
36.8 x 23.8 cm

Overall Dimensions (L x W x H): 15.9 x 18.4 x 10.5"  
40.3 x 46.7 x 26.7 cm

### Part Number:

120 VAC/60 Hz

240 VAC/50 Hz

**HPLAT-30-A11B**

**HPLAT-30-A12E**



## Features:

- Fast-freeze cold plate allows histotechnicians to observe tissue freezing and keep specimen edges flat
- 136 in<sup>2</sup> (877 cm<sup>2</sup>) freezing surface accommodates multiple specimens simultaneously

- Ultra-cold surface freezes samples quickly, reduces overall processing time by 40% or more



Electrical plugs for the part numbers listed are standard U.S. and European types. See page 128 for additional plug types and part numbers.

# Coliform Bath

## Key Specifications

Temperature Range:	Ambient +10°C to 135°C
Temperature Stability:	±0.07°C
Pump:	1-speed
Working Access (L x W x D):	11.8 x 12.9 x 8.3" 30 x 32.8 x 21.1 cm
Overall Dimensions (L x W x H):	13.9 x 21.5 x 18" 35.3 x 54.6 x 45.7 cm
Heater:	1100 W (50/60Hz)

## Part Number:

120 VAC/60 Hz  
240 VAC/50 Hz

**MX28C135-A11B**  
**MX28C135-A12E**



## Features:

- Ideal for fecal coliform and *E.coli* testing
- MX Temperature Controller
- 28 liter reservoir with hinged, see-through cover
- Large, easy to read display
- Calibration capability
- DuraTop™
- Large bath opening

The PolyScience Coliform Bath is specifically designed for the following Coliform tests:

- APHA, AWWA, WEF and EPA fecal coliform determinations at 44.5°C as specified in “*Standard Test Methods for the Examination of Water and Wastewater*” (19th edition). The membrane filter method or MPM method can be used.
- AOAC determination of *E.coli* at 45.5°C
- APHA, AWWA, WEF 7-hour Fecal Coliform Test at 41.5°C
- Defined Substrate Technology® tests for *E.coli* and total coliform at 35.0°C



Electrical plugs for part numbers listed are standard U.S. and European types. See page 128 for additional plug types and part numbers. For additional information on the MX Temperature Controller's features and capabilities, see pages 26 and 27.

# Refrigerated and Heated Circulator and Specialty Product Accessories

	Refrigerated & Heated Baths	Open Bath Systems	75 L Circulating Bath	Viscosity Baths	Calibration Baths	Cryoprecipitate & Coliform Bath	Histology Products	Quantity	Part Number
<b>TEMPERATURE MEASUREMENT</b>									
External Pt100 Probe. For monitoring the temperature of an external application 3/16" (4.7 mm) diameter x 6" (15.2 cm)									
Cable length: 2' (0.6 m)	•	•	•		•			1 each	525-876
Cable length: 10' (3 m)	•	•	•		•			1 each	525-870
Cable length: 25' (7.6 m)	•	•	•		•			1 each	525-871
Cable length: 50' (15 m)	•	•	•		•			1 each	525-872
In-line Pt100 Temperature Sensor, brass, 10' (3 m) cable	•	•	•					1 each	510-670
Thermometer (-20° to +150°C) alcohol, non-calibrated		•				•		1 each	099590
Thermometer Holder		•				•		1 each	700-437
<b>COMMUNICATION</b>									
RS232 Cable, 9.8' (3 m)	•	•	•	•	•			1 each	225-173
Ethernet Cable, 7' (2.1 m)	•	•	•	•	•			1 each	225-670
PolyScience-branded Flash Drive, 1 GB	•	•	•	•	•			1 each	250-096
USB-A to Mini-B Cable, 1.8 m (6')	•	•	•	•	•			1 each	225-669
Digital to Analog Adapter, 10 mV	•	•	•	•	•			1 each	215-471
<b>COOLING ACCESSORIES</b>									
Cooling Coil Kit. For Open Bath Circulators with 3.63" diameter access port in bridge (10, 20 and 28 liter stainless steel tanks; 17, 23 and 28 liter polycarbonate tanks) and Coliform bath.		•				•		1 each	510-649
<b>BATH ACCESSORIES</b>									
Histology Immersion Basket, stainless steel mesh							•	1 each	703-023
Sample Rack, stainless steel			•					1 each	510-744
Base with locking casters for 15, 20, 28 L Circulators	•							1 each	505-194









	Open Bath Systems	75 L Circulating Bath	Viscosity Baths	Calibration Baths	Histology Products	Quantity	Part Number
<b>COVERS &amp; LIDS</b>							
Bath Cover, 8 L Polycarbonate Open Bath	•					1 each	510-693
Bath Cover, 11 L Polycarbonate Open Bath	•					1 each	510-694
Bath Cover, 14 L Polycarbonate Open Bath	•					1 each	510-695
Bath Cover, 17 L Polycarbonate Open Bath	•					1 each	510-696
Bath Cover, 23 L Polycarbonate Open Bath	•					1 each	510-697
Bath Cover, 28 L Polycarbonate Open Bath	•					1 each	510-698
Bath Cover, 6 L Stainless Steel Open Bath	•					1 each	510-700
Bath Cover, 10 L Stainless Steel Open Bath	•					1 each	510-701
Bath Cover, 20 L/28 L Stainless Steel Open Bath	•					1 each	510-702
Floating Ball Cover: Covers top of any open tank. Reduces fumes, splashing hazard, and heat loss by 75% and evaporation by 87%. Usable to 110°C. 3/4" (19 mm) diameter, 400/package	•					1 pkg	060301
Histology Freeze Plate Cover					•	1 each	510-526
Viscosity Bath Top with 5 round holes & hole covers, for 29 L viscosity bath			•			1 set	510-707
Viscosity Bath Top with 9 round holes & hole covers, for 29 L viscosity bath			•			1 set	510-708
Viscosity Bath Top with 3 square holes & hole covers, for 29 L viscosity bath			•			1 set	510-709
Viscometer Holder, removable. For viscosity baths with round openings.			•			1 each	300-863
75 L Bath Cover, polycarbonate		•				1 each	300-829
Sleeve Kit for calibration bath lid: 2 mm inserts x (2), 4.0 mm insert x (1)				•		1 kit	510-748
Sleeve Kit for calibration bath lid: 3 mm inserts x (2), 4.0 mm insert x (1)				•		1 kit	510-745
Sleeve Kit for calibration bath lid: 4 mm inserts x (2), 4.0 mm insert x (1)				•		1 kit	510-746
Sleeve Kit for calibration bath lid: 5 mm inserts x (2), 4.0 mm insert x (1)				•		1 kit	510-749
Sleeve Kit for calibration bath lid: 6 mm inserts x (2), 4.0 mm insert x (1)				•		1 kit	510-747
Sleeve Kit for calibration bath lid: 8 mm inserts x (2), 4.0 mm insert x (1)				•		1 kit	510-750
Solid Plug for calibration bath lid, Viton®				•		1 each	300-831
Drain Cap, replacement, for polycarbonate tanks	•					1 each	510-756



# Refrigerated and Heated Circulator and Specialty Product Accessories

## TEST TUBE RACKS

Modular design allows use with multiple tube sizes and different immersion depths with a single rack	Maximum Racks per Tank										Part Number	
	Stainless Steel				Polycarbonate							
Tank Material	6 L	10 L	20 L	28 L	8 L	11 L	14 L	17 L	23 L	28 L		
Stainless Steel Rack 10-13 mm, holds 15 maximum	1										510-672	
Stainless Steel Rack 14-18 mm, holds 15 maximum	1										510-673	
Stainless Steel Rack 10-13 mm, holds 30 maximum		1	2	2							510-674	
Stainless Steel Rack 14-18 mm, holds 30 maximum		1	2	2							510-675	
Polycarbonate Rack 10-18 mm, holds 24 maximum					1	2	3				300-777	
Polycarbonate Rack 10-18 mm, holds 52 maximum								1	2	3	300-778	

## AIR FILTERS







	Quantity	Part Number
For 07R-20 and 07R-40 Circulators	1	305-054
For 7LR-20 Circulator	1	305-057
For 15R-30, 15R-40, 20R-30, and 28R-30 Circulators	1	305-055
For 45R-20 Circulator	1	305-056
For 15 L Refrigerated Calibration Bath	1	305-054
For 75 L Refrigerated Circulating Bath	1	305-056
For Cryoprecipitate Bath	1	750-855
For Histology Bath	1	305-054



## CALIBRATION CERTIFICATES

	Part Number
Calibration Certificate, 1 point	130-346
Calibration for 2 through 10 points (added to original certificate)	130-347



TUBING/FITTINGS/ADAPTERS	Refrigerated & Heated Baths	Open Bath Systems	75 L Circulating Bath	Viscosity Baths	Calibration Baths	Quantity	Part Number	
Tubing. Select by temperature range. Order in continuous length, multiples of 1 m (39").								
Buna N Tubing (synthetic rubber), 1/4" (8 mm) ID, -40 to 120°C	•	•	•	•	•	1 m (39")	060307	
Teflon®-lined Tubing, 1/4" (8 mm), stainless steel overbraid with 1/4" NPT quick connects. -50° to 225°C. Available only in 3' (.9 m) length.	•	•	•	•	•	1 m (39")	060310	
Viton® Tubing, 3/8" (9.5 mm) ID, -32 to 200°C	•	•	•	•	•	1 m (39")	060319	
Insulation for all 1/4" (6.3 mm) tubing above - 1 m (39") lengths	•	•	•	•	•	1 m (39")	060309	
Bypass Kit, replacement, Buna N tubing, 1/2" ID x 6" with spring and 2 hose clamps, -40° to 120°C	•	•	•	•	•	1 kit	510-711	
Bypass Kit for higher temperatures, Viton® tubing, 1/2" ID x 6" with spring and 2 hose clamps, -32 to 200°C	•	•	•	•	•	1 kit	510-495	
Bypass Kit, silicone tubing 1/2" ID x 6", MX Controllers only	•	•				1 kit	510-713	
Tube Clamp for 1/4" (8 mm) and 3/8" (10 mm) tubing, stainless steel	•	•	•		•	1 each	400-881	

# Refrigerated and Heated Circulator and Specialty Product Accessories

	Refrigerated & Heated Baths	Open Bath Systems	75 L Circulating Bath	Calibration Baths	Quantity	Part Number
<b>FITTINGS/ADAPTERS</b>						
Fittings/Adapters: Connect ports on back of Temperature Controller to tubing going to external process. 1/4" NPT to M16 adapter supplied with 50 Hz for connecting metric fittings.						
Fitting, 1/4" male NPT x 1/8" (3 mm) hose barb, brass	•	•	•	•	set of 2	060306
Fitting, 1/4" male NPT x 3/16" (5 mm) hose barb, nylon	•	•	•	•	1 each	300-049
Fitting, 1/4" male NPT to 3/16" (5 mm) hose barb, brass	•	•	•	•	1 each	776-193
Fitting, 1/4" male NPT x 3/16" (5 mm) hose barb, stainless steel	•	•	•	•	1 each	776-204
Fitting, 1/4" male NPT x 1/4" (6 mm) hose barb, nylon	•	•	•	•	1 each	300-048
Fitting, 1/4" male NPT to 1/4" (6 mm) hose barb, brass	•	•	•	•	1 each	776-194
Fitting, 1/4" male NPT x 1/4" (6 mm) hose barb, stainless steel	•	•	•	•	1 each	776-203
Fitting, 1/4" male NPT x 5/16" (8 mm) hose barb, straight, brass, 2 each	•	•	•	•	set of 2	060305-2
Fitting, 1/4" male NPT x 3/8" (9.5 mm) hose barb, nylon	•	•	•	•	1 each	300-047
Fitting, 1/4" male NPT to 3/8" (9.5 mm) hose barb, brass	•	•	•	•	1 each	776-195
Fitting, 1/4" male NPT x 3/8" (9.5 mm) hose barb, stainless steel	•	•	•	•	1 each	776-202
Fitting, 1/4" male NPT x M16x1, stainless steel	•	•	•	•	1 each	775-290
Fitting, M16x1 female to 8 mm (1/4") hose barb, brass	•	•	•	•	1 each	776-191
Fitting, M16x1 female to 12 mm (7/16") hose barb, brass	•	•	•	•	1 each	776-192
Fitting, 1/2" (13 mm) barb x 5/16" (5 mm) barb, glass-filled nylon (for MX Controllers)	•	•			1 each	776-206
Fitting, 1/2" (13 mm) barb x 1/4" (6 mm) barb, glass-filled nylon (for MX Controllers)	•	•			1 each	776-207
Fitting, 1/2" (13 mm) barb x 3/8" (9.5 mm) barb, glass-filled nylon (for MX Controllers)	•	•			1 each	776-205
Fitting, 1/2" Male NPT x 5/8" (16 mm) hose barb, nylon, straight (for integrated cooling coils)	•			•	1 each	300-131
Fitting, 1/2" Male NPT x 1/2" (13 mm) hose barb, nylon, straight (for integrated cooling coils)	•			•	1 each	300-096
Flow adapter, two (2) port with shutoffs, brass 1/4" male NPT x 2 @ 1/4" (6 mm) hose barb	•	•		•	1 each	510-666



BATH FLUIDS <sup>1</sup>			Temperature Range	Quantity	Part Number	Refrigerated Circulating Baths	Heating Circulating Baths	Open Bath Systems	75 L Circulating Bath	Viscosity Baths	Calibration Baths	Cryoprecipitate Bath	Histology Products	Coliform Bath	
Cleaners	polyclean ALGAECIDE	Prevents growth of algae, keeps baths clean and odor-free. Concentrated: 8 oz (237 ml) treats approximately 200 gallons (757 liters).	n/a	8 oz (237 ml)	004-300040	•	•	•	•	•	•	•	•	•	
				case = 12 x 8 oz (237 ml)	004-300041										
	polyclean BATH CLEANER	For cleaning and removing rust and mineral deposits from stainless steel and polycarbonate baths. Concentrated: 8 oz (237 ml) treats approximately 16 gallons (60.5 liters).	n/a	8 oz (237 ml)	004-300050										
				case = 12 x 8 oz (237 ml)	004-300051										
High Temperature Fluids	polytherm S150	Silicone heat transfer fluid. Superior thermal stability over the temperature range. For use in stainless steel tanks. Temperature range not compatible with Buna N or natural rubber.	50° to 150°C (122° to 302°F)	1 gallon (3.8 L)	060326	•	•	•	•	•					
	polytherm S200	High temperature silicone heat transfer fluid. For use in stainless steel tanks. Temperature range not compatible with Buna N or natural rubber.	100° to 200°C (212° to 392°F)	1 gallon (3.8 L)	060327	•	•	•	•	•					
	polytherm S250	High temperature silicone heat transfer fluid. For use in stainless steel tanks. Temperature range not compatible with Buna N or natural rubber.	150° to 250°C (302° to 482°F)	1 gallon (3.8 L)	060328	•	•	•	•	•					
	polytherm M170	Mid-range mineral oil provides cost-effective alternative to silicone oil. For use in stainless steel and polycarbonate tanks.	50° to 170°C (122° to 338°F)	1 gallon (3.8 L)	060321	•	•	•	•	•					
Low Temperature Fluids	polycool HC -50	Excellent low-temperature performance without toxicity or risk to environment, equipment, or personnel. Provides low-temp properties of synthetic organic and silicone fluids with thermal properties of water-based glycols.	-50° to 100°C (-58° to 148°F)	1 gallon (3.8 L)	060330	•			•		•	•	•		
	polycool EG -25	A common circulator antifreeze fluid. Lowers the freezing point of water to allow circulation at below freezing temperatures. High toxicity. Recommend mixing with distilled water for broadest temperature range.	-25° to 100°C (-13° to 212°F) when mixed 50%/50% with distilled water	1 gallon (3.8 L)	060340	•			•		•				
	polycool PG -20	Propylene glycol is a safer alternative to ethylene glycol. Lowers freezing point of water to allow circulation at below freezing temperatures. Mix with distilled water for broadest temperature range.	-20° to 100°C (-4° to 212°F) when mixed 50%/50% with distilled water	1 gallon (3.8 L)	060320	•			•				•		
Fluid Mixes	polycool MIX -25	Optimizes performance in refrigerated products; protects against freezing and algae growth.	-25° to 100°C (-13° to 212°F)	case = 5 x 1/2 gallon (1.9 L)	004-300060	•			•		•				
	polyclear MIX 30	General purpose fluid for routine applications above 15°C; prevents algae growth.	15° to 90°C (59° to 194°F)	case = 5 x 1/2 gallon (1.9 L)	004-300062		•	•	•	•	•			•	

1. For all fluids except polyclean Bath Cleaner, check bath system compatibility before using.

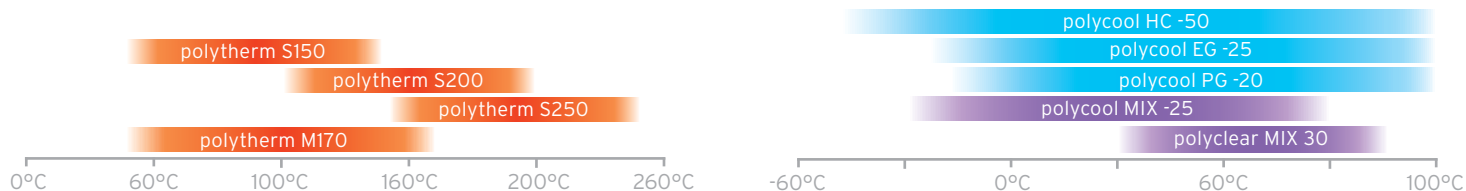

## General Purpose Water Baths

Water Baths. Simplicity and consistency in economy or digital.

Basic lab equipment doesn't have to be rudimentary. PolyScience General Purpose Water Baths are a sleek, cleanly designed addition to your bench offering absolute control, precision and convenience. Operation is totally straightforward. Not only can you set temperatures of up to 100°C, but you can also clearly view the readout on a bright LED display that allows you to recall your set-point temperature with just the press of a button. In addition, you can store up to three temperature set-points that you use most often.

You'll also appreciate the user-friendliness we've built in. Like the steeply gabled, polycarbonate cover that accommodates glassware of varying heights, tilts out of the way when you're loading or unloading samples and allows condensate to drain neatly back into the bath. Not on your work surface.

PolyScience Water Baths, available in a range of capacities from 2 liters to 28 liters in both economy and digital models, provide the perfect blend of scientific accuracy and utility for day-to-day laboratory tasks.



- 
- 86-87 Digital
  - 88-89 Economy
  - 90-91 General Purpose Water Bath Accessories
-



## General Purpose Water Baths – Digital

PolyScience General Purpose Water Baths offer excellent temperature control, range, and uniformity. Easy to use Digital Temperature Controller features three temperature pre-sets for one-touch selection of frequently used set-points plus a user-settable high limit alarm that alerts you if the bath temperature exceeds pre-set limits.

### Key Specifications

Temperature Range: Ambient +5° to 100°C

Temperature Uniformity:  $\pm 0.2^{\circ}\text{C}$

Temperature Stability:  $\pm 0.25^{\circ}\text{C}$



## Features:

- Hinged gable cover
- Digital Temperature Controller with 3 pre-sets for frequently used temperatures
- Calibration capability
- Local lockout helps prevent unauthorized set-point changes
- Reservoir sizes from 2 to 28 liters
- Primary and automatic safety thermostats
- Shaking bath option (20 L and 28 L baths)



Adjustable pre-sets make selecting commonly used temperatures as simple as pressing a button.



See-through gable cover accommodates flasks and other tall sample vessels, tilts out of the way when opened to allow condensate to drain back into the bath.



**Digital 2 Liter: +100°C**

Temperature Range:  
Ambient +5° to +100°C

Working Access (L x W x D):  
3.9 x 4.3 x 5.5"  
9.9 x 10.9 x 14 cm

Overall Dimensions (L x W x H):  
10.2 x 8.0 x 11.8"  
25.9 x 20.3 x 30 cm

**Digital 2 Liter Shallow: +100°C**

Temperature Range:  
Ambient +5° to +100°C

Working Access (L x W x D):  
5 x 10.8 x 1.9"  
12.7 x 27.4 x 4.8 cm

Overall Dimensions (L x W x H):  
10.6 x 13.6 x 12"  
26.9 x 34.5 x 30.4 cm

**Digital 5 Liter: +100°C**

Temperature Range:  
Ambient +5° to +100°C

Working Access (L x W x D):  
5 x 10.8 x 5.5"  
12.7 x 27.4 x 14 cm

Overall Dimensions (L x W x H):  
10.6 x 13.6 x 12"  
26.9 x 34.5 x 30.4 cm

**Digital 10 Liter: +100°C**

Temperature Range:  
Ambient +5° to +100°C

Working Access (L x W x D):  
10.6 x 11.6 x 5.5"  
26.9 x 29.5 x 14 cm

Overall Dimensions (L x W x H):  
16.7 x 14.8 x 11.8"  
42.4 x 37.6 x 30 cm



**Digital 20 Liter: +100°C**

Temperature Range:  
Ambient +5° to +100°C

Working Access (L x W x D):  
9.5 x 17.5 x 5"  
24.1 x 44.5 x 12.7 cm

Overall Dimensions (L x W x H):  
16.4 x 21.6 x 12"  
41.5 x 54.8 x 30.5 cm

**Digital 28 Liter: +100°C**

Temperature Range:  
Ambient +5° to +100°C

Working Access (L x W x D):  
9.5 x 17.5 x 7"  
24.1 x 44.5 x 17.8 cm

Overall Dimensions (L x W x H):  
16.4 x 21.6 x 14.1"  
41.5 x 54.8 x 35.8 cm

Reservoir	2 Liter	2 Liter Shallow	5 Liter	10 Liter	20 Liter	28 Liter	20 Liter Shaker/Bath	28 Liter Shaker/Bath
Temperature Range	Ambient +5° to +100°C							
Heater (50 & 60 Hz)	300 W	300 W	500 W	500 W	1000 W	1000 W	1000 W	1000 W
Part Number 120 VAC/60 Hz	WD02A11B	WD2SA11B	WD05A11B	WD10A11B	WD20A11B	WD28A11B	WDS20A11B	WDS28A11B
Part Number 240 VAC/50 Hz	WD02A12E	WD2SA12E	WD05A12E	WD10A12E	WD20A12E	WD28A12E	WDS20A12E	WDS28A12E

Electrical plugs for the part numbers listed are standard U.S. and European types. See page 128 for additional plug types and part numbers.

## General Purpose Water Baths – Economy

PolyScience General Purpose Water Baths with the Economy Temperature Controller provide economical yet precise heating for laboratory applications which do not require frequent set-point changes.

### Key Specifications

Temperature Range: Ambient +5° to 100°C

Temperature Uniformity:  $\pm 0.2^{\circ}\text{C}$

Temperature Stability:  $\pm 0.25^{\circ}\text{C}$



## Features:

- Economical dial type temperature controller
- Hinged gable cover
- Easy to clean stainless steel tank
- Reservoir sizes from 2 to 28 liters
- Shaking bath option (20 L and 28 L baths)
- Easy, straightforward setup/control

## Shaker Bath Accessory

### Features:

- For 20 and 28 liter PolyScience general purpose water baths
- User-selectable and adjustable orbital (2 to 12 mm diameter) or reciprocal (2 to 12 mm stroke length) motion
- Adjustable agitation speed (30 to 180 rpm)



Fits Bath Size	20 Liter	28 Liter
Platform Dimensions (L x W x H)	17.5 x 26.25 x 16.5" 44.5 x 66.7 x 42 cm	17.5 x 26.25 x 18.5" 44.5 x 66.7 x 47 cm
Part Number 120 VAC/60 Hz	040671	040675
Part Number 240 VAC/50 Hz	040673	040677

Electrical plugs for the part numbers listed are standard U.S. and European types. Contact Customer Service for additional plug types and part numbers.





**Economy 2 Liter: +100°C**

Temperature Range:  
Ambient +5° to +100°C

Working Access (L x W x D):  
3.9 x 4.3 x 5.5"  
9.9 x 10.9 x 14 cm

Overall Dimensions (L x W x H):  
11 x 8 x 11.8"  
27.7 x 20.3 x 30 cm

**Economy 2 Liter Shallow: +100°C**

Temperature Range:  
Ambient +5° to +100°C

Working Access (L x W x D):  
5 x 10.8 x 1.9"  
12.7 x 27.4 x 4.8 cm

Overall Dimensions (L x W x H):  
11.4 x 13.6 x 12"  
28.9 x 34.5 x 30.4 cm

**Economy 5 Liter: +100°C**

Temperature Range:  
Ambient +5° to +100°C

Working Access (L x W x D):  
5 x 10.8 x 5.5"  
12.7 x 27.4 x 14 cm

Overall Dimensions (L x W x H):  
11.4 x 13.6 x 12"  
28.9 x 34.5 x 30.4 cm

**Economy 10 Liter: +100°C**

Temperature Range:  
Ambient +5° to +100°C

Working Access (L x W x D):  
10.6 x 11.6 x 5.5"  
26.9 x 29.5 x 14 cm

Overall Dimensions (L x W x H):  
17.5 x 14.8 x 11.8"  
44.5 x 37.6 x 30 cm



**Economy 20 Liter: +100°C**

Temperature Range:  
Ambient +5° to +100°C

Working Access (L x W x D):  
9.5 x 17.5 x 5"  
24.1 x 44.5 x 12.7 cm

Overall Dimensions (L x W x H):  
17.1 x 21.6 x 12"  
43.4 x 54.8 x 30.5 cm

**Economy 28 Liter: +100°C**

Temperature Range:  
Ambient +5° to +100°C

Working Access (L x W x D):  
9.5 x 17.5 x 7"  
24.1 x 44.5 x 17.8 cm

Overall Dimensions (L x W x H):  
17.1 x 21.6 x 14.1"  
43.4 x 54.8 x 35.8 cm

Reservoir	2 Liter	2 Liter Shallow	5 Liter	10 Liter	20 Liter	28 Liter	20 Liter Shaker/Bath	28 Liter Shaker/Bath
Temperature Range	Ambient +5° to +100°C							
Heater (50 & 60 Hz)	300 W	300 W	500 W	500 W	1000 W	1000 W	1000 W	1000 W
Part Number 120 VAC/60 Hz	WA02A11B	WA2SA11B	WA05A11B	WA10A11B	WA20A11B	WA28A11B	WAS20A11B	WAS28A11B
Part Number 240 VAC/50 Hz	WA02A12E	WA2SA12E	WA05A12E	WA10A12E	WA20A12E	WA28A12E	WAS20A12E	WAS28A12E

Electrical plugs for the part numbers listed are standard U.S. and European types. See page 128 for additional plug types and part numbers.

# General Purpose Water Bath Accessories

	Digital Water Baths	Economy Water Baths	Shaking Water Baths	Quantity	Part Number
Thermometer (-20 to +150°C) alcohol, non-calibrated	•	•	•	1 each	099590
Thermometer Holder	•	•	•	1 each	700-437
<b>Concentric Rings (4 rings per hole): 3/4" (1.9 cm), 1 3/8" (3.5 cm), 2 1/8" (5.4 cm), 3 1/8" (7.8 cm)</b>					
Concentric Ring Cover for 10 L: 4-hole cover with 4 ring sets	•	•		1 set	040678
Concentric Ring Cover for 20/28 L: 6-hole cover with 6 ring sets	•	•		1 set	040679
Concentric Ring Set, replacement (4 rings)	•	•		1 set	040649
Floating Ball Cover: Covers top of tank, reducing heat loss by 75% and evaporation by 87%. Also reduces fumes and splashing hazards. 3/4" (20 mm) diameter, 400/package	•	•		1 package	060301
<b>TEST TUBE RACKS FOR GENERAL PURPOSE BATHS</b>					
	Maximum Racks per Tank				
	5 L	10 L	20 L	28 L	Part Number
Stainless Steel Rack, 10-13 mm, holds 15 maximum	2				510-672
Stainless Steel Rack, 14-18 mm, holds 15 maximum	2				510-673
Stainless Steel Rack, 10-13 mm, holds 30 maximum		3	3	3	510-674
Stainless Steel Rack, 14-18 mm, holds 30 maximum		3	3	3	510-675
<b>FLASK HOLDERS FOR SHAKING BATHS</b>					
	Maximum per Sample Tray				
	20 L	28 L			Part Number
1000 ml	4	4			040810
500 ml	4	4			040808
250 ml	6	6			040806
125 ml	8	8			040804
50 ml	24	24			040802
25 ml	48	32			040800

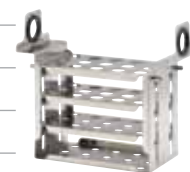

BATH FLUIDS <sup>1</sup>				
Name	Description	Temperature Range	Quantity	Part Number
polyclean ALGAECIDE	Prevents growth of algae, keeps baths clean and odor-free. Cleans existing algae and prevents future outbreak. Concentrated: 8 oz (237 ml) treats approximately 200 gallons (757 L).	n/a	8 oz (237 ml)	004-300040
			case = 12 x 8 oz (237 ml)	004-300041
polyclean BATH CLEANER	For cleaning and removing rust and mineral deposits from stainless steel and polycarbonate tanks. Concentrated: 8 oz (237 ml) treats approximately 16 gallons (60.6 L).	n/a	8 oz (237 ml)	004-300050
			case = 12 x 8 oz (237 ml)	004-300051
polytherm M170	Mid-range oil provides cost-effective alternative to silicone oil. For use in stainless steel and polycarbonate tanks.	50° to 170°C (122° to 338°F)	1 gallon (3.8 L)	060321
polyclear MIX 30	General purpose fluid for routine applications above 15°C; prevents algae growth.	15° to 90°C (59° to 194°F)	case = 5 x 1/2 gallon (1.9 L)	004-300062

1. For all fluids except cleaners, check bath system compatibility before using.

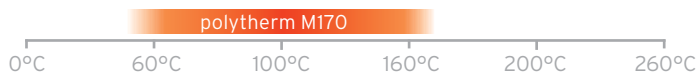

# Chillers and Coolers

PolyScience has the right equipment for virtually any end-user or OEM application.

PolyScience Chillers and Coolers have proven – over several decades and hundreds of thousands of Original Equipment Manufacturer (OEM) installations ranging from lasers to analytical equipment, reactors and manufacturing equipment – that they are the most reliable in the industry. We understand that precise temperature control can make or break a complex piece of machinery. Our Chillers and Coolers provide consistent performance day after day, year after year. And that means they are the smartest choice for clients all over the world.

- **Compact, Benchtop Chillers**

Our powerful, low-temperature chillers are well matched for use with rotary evaporators, vacuum systems, spectrometers, and other analytical instrumentation. They also are available with a mobile cart accessory for convenient placement under a bench.

- **6000 Series Recirculating Chillers**

Why run a fan at its highest speed and noise level when a fraction will do? Typical cooling fans have two speeds – full speed and off. PolyScience's patent-pending WhisperCool™ technology automatically adjusts the cooling fan speed to match the demand put on the system exactly – making these high performance Recirculating Chillers exceptionally quiet and environmentally friendly.

- **DuraChill™ Recirculating Chillers**

Designed for high heat removal in demanding environments, our DuraChill™ Chillers provide robust and reliable temperature control for closed, external systems such as pilot plants, medical diagnostic equipment, metalworking lasers, and plastic molding machines. These chillers are suitable for most applications with their many options and accessories.

- **Recirculating Coolers (Non-Refrigerated)**

Available in both Liquid-to-Air and Liquid-to-Liquid models, PolyScience Recirculating Coolers deliver extremely quiet and energy-efficient heat removal. They provide significant cooling for set-points above ambient, without the energy consumption of refrigerated chillers.

96-106	Chillers	102-106	Portable Chillers	109-110	Factory Installed Chiller Options
96	Selection Guide: Benchtop and 6000 Series	102-103	6000 Series	111-112	Chiller Fluids and Accessories
97	Selection Guide: DuraChill™	104-106	DuraChill™	113-115	Low Temperature Coolers
98-101	Benchtop Chillers	107-108	Recirculating Coolers	114	Immersion Probe
98-99	LS Series	107	Model 3370 Liquid-to-Air Cooler	115	Flow-through
100	LM Series	108	Model 4100 Liquid-to-Liquid Cooler		
101	MM Series				



### Chiller Selection Guide Based On Heat Removal (kW)

Cooling Range	.5 kW	1 kW	2 kW	3 kW	4 kW	5 kW	6 kW	8 kW	10 kW	30 kW	50 kW
<b>Chillers (refrigerated)</b>											
LS, LM, and MM Benchtop Models											
6000 Series Portable Models											
DuraChill™ Portable Models											
<b>Coolers (non-refrigerated)</b>											
Model 3370 Liquid-to-Air											
Model 4100 Liquid-to-Liquid											

PolyScience Recirculating Chillers and Recirculating Coolers provide stable, reliable and quiet temperature control over a broad range of cooling capacities for lasers, analytical instrumentation, biological experiments, and other temperature-sensitive equipment and applications.



## Features:

- **Precise & reliable**

Engineered and field-proven to deliver industry-leading performance, PolyScience Recirculating Chillers and Coolers provide dependable and efficient heat removal day in, day out, year after year.

- **Easy to operate**

Setting temperature and operational parameters is intuitive and straightforward.

- **Globally supported**

PolyScience ensures responsive local support through our global distribution and service network that spans 6 continents and 70 countries.

- **Quiet**

Our commitment to noise reduction in your working environment, including our patent-pending WhisperCool™ technology, helps make your cooling application exceptionally quiet and energy efficient.

- **Informative**

Digital temperature display, digital pressure/flow rate display, and fluid level gauge let you check key process information with just a glance.

- **Secure**

Local lockout prevents unauthorized set-point or operational changes. User-adjustable temperature limits prevent unintended set-point changes, warn you when process temperature rises too high or drops too low.



- **Low maintenance**

Readily accessible, reusable fluid and air filters are easily removed for cleaning, helping simplify maintenance and ensuring energy efficiency.

- **Versatile**

Whether your application calls for high flow at low pressure, low flow at high pressure, or something in between, PolyScience Recirculating Chillers can deliver. Each unit is available with multiple pump options ensuring a good fit for most process requirements.

- **Customizable**

Broad selection of factory installed options – such as remote control, ambient temperature tracking, serial communication, and deionized water packages to name just a few – makes it easy to customize your PolyScience Chiller or Recirculating Cooler to your facility's and application's unique needs.

- **Cool Command™**

Advanced refrigeration technology carefully monitors heat load to deliver the precise amount of cooling needed. The result? Exceptional temperature control – over the entire temperature range – as well as more reliable and energy-efficient cooling.

# Chiller Selection Guide: Benchtop & 6000 Series



Benchtop Chillers



Portable 6000 Series Chillers

	Air-Cooled			Air-Cooled				
	MM	LM	LS	6200	6300	6500	6700	6100
Cooling Capacity @ 20°C <sup>1</sup>	460 W	560 W	1290 W	950 W	1430 W	1800 W	2350 W	2900 W
Temperature Range	-5° to +50°C	-10° to +30°C	-20° to +40°C	-10° to +40°C (-10° to +70°C with heater option) <sup>2</sup>				
Temperature Stability	±0.1°C	±0.1°C	±0.1°C	±0.1°C	±0.1°C	±0.1°C	±0.1°C	±0.1°C
Maximum Pressure psi (bar)	14.5 (1.0)	14.5 (1.0)	14.5 (1.0)	100 (6.9)	100 (6.9)	100 (6.9)	100 (6.9)	100 (6.9)
Maximum Flow gpm (l/min)	3.5 (13.2)	3.5 (13.2)	3.9 (14.8)	4.1 (15.5)	4.1 (15.5)	4.1 (15.5)	4.1 (15.5)	4.1 (15.5)

1. Cooling Capacity based on 20°C (68°F) ambient temperature and a 50%/50% mix of ethylene glycol and distilled water as coolant.
2. Heater option extends cooling range to 50°C, provides heat up to 70°C.
3. Cooling capacity for 5.2 - 10.5 kw chillers based on 20°C (68°F) ambient temperature and a 50%/50% mix of ethylene glycol and distilled water as coolant. Cooling capacity for 16.3 - 33.5 kw chillers based on 35°C/95°F entering air, 49°C/120°F condensing temperature, and 10°C/50°F leaving water. Allowance made for heat gain from pump.
4. Cooling capacity for 3370 based on 11°C temperature differential between ambient air temperature and cooling fluid temperature.
5. Cooling capacity for 4100 given at 30°C using 20°C facility water.



# Chiller Selection Guide: DuraChill™



Portable DuraChill™ Chillers<sup>3</sup>

Non-Refrigerated Coolers

Air-Cooled		Air-Cooled		Air-Cooled		Air-Cooled		Air-Cooled		Water Cooled	Water Cooled	Air-Cooled	Water Cooled
6860	DCA200	DCA300	DA500	DA750	DA1000	6960	DCW300	3370	4100				
5200 W	7000 W	10,500 W	16,384 W	22,361 W	33,436 W	6328 W	10,936 W	4000 W <sup>4</sup>	10,000 W <sup>5</sup>				
5° to 35°C	5° to 35°C	5° to 35°C	0° to 30°C	0° to 30°C	0° to 30°C	5° to 35°C	5° to 35°C	Ambient +5° to 70°C	Facility Water +10° to 60°C				
±0.5°C	±0.5°C	±0.5°C	±1.11°C	±1.11°C	±1.11°C	±0.5°C	±0.5°C	N/A	±0.4°C				
100 (6.9)	20.5 (1.41)	20.5 (1.41)	40 (2.8)	40 (2.8)	55 (3.8)	100 (6.9)	20.5 (1.41)	100 (6.9)	100 (6.9)				
3.5 (13.25)	12 (45.1)	12 (45.1)	50.2 (190)	50.2 (190)	64.7 (245)	3.5 (13.25)	12 (45.1)	5.4 (20.5)	3.5 (13.2)				

Specifications listed are for 60 Hz models. For specifications on 50 Hz models see Technical Specification pages 150 thru 153. Benchtop Chillers, 6000 Series Chillers, DuraChill™ Chillers, and Non-Refrigerated Coolers may have the following wetted parts present: Polypropylene, nylon, SBR rubber, stainless steel, bronze, brass.

## A Variety of Pump Options

### Turbine:

Provide moderate flow but at higher pressures which make them well suited to applications that require higher pressure or experience a higher pressure drop. A robust design makes turbine pumps very reliable and more forgiving to impurities in the fluid stream.

### Positive Displacement Pumps:

Have performance characteristics similar to turbine pumps and are suitable for high viscosity fluids, or pumping higher or further from the cooling product and the application.

### Centrifugal Pumps (Magnetic Drive):

Offer higher relative flow rates at lower pressures and are suitable for applications that are in close proximity to the chiller or require lower pressure. Centrifugal pumps are more sensitive to pressure drops.

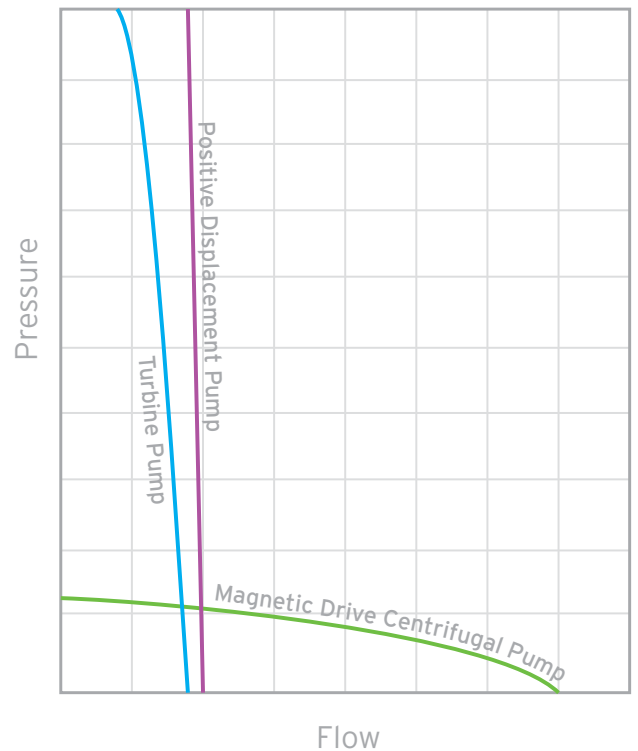

# Benchtop Chillers - LS Series -20° to +40°C

## Key Specifications

Working Temperature: -20° to +40°C

Temperature Stability: ±0.1°C

Cooling Capacity: Up to 1290 W @ 20°C

Reservoir Capacity: 0.7 gallons/2.65 liters

Overall Dimensions (L x W x H): 23.9 x 10 x 19"  
60.7 x 25.4 x 48.3 cm



## Features:

- Optimized for high performance at low temperatures
- Capable of cooling multiple rotary evaporators
- WhisperCool™ Environmental Control System
- Large, easy to read LED display
- Space-saving design
- Cooling at ambient temperatures as high as 35°C
- Low flow shutoff and alarm, high and low temperature alarms
- Simple setup, operation, and maintenance
- Choice of pumps
- Fluid level indicator



Front mounted fluid level gauge lets you quickly determine if coolant needs to be added to the reservoir.

See pages 109 through 112 for LS Series Chiller options and accessories.

Working Temperature Range	-20° to +40°C						
Temperature Stability	±0.1°C						
Pump Type	Centrifugal		Centrifugal		Turbine		
	M1 (60 Hz)	M2 (50 Hz)	MX (60 Hz)	MY (50 Hz)	M1 (60 Hz)	M2 (50 Hz)	
Cooling Capacity <sup>1</sup> @ (W)	-20°C	230	230	260	240	150	140
	-10°C	435	435	475	460	345	330
	0°C	680	680	750	700	540	500
	+10°C	1030	1030	1130	1070	790	750
	+20°C	1160	1160	1290	1190	900	830
	+30°C	1380	1380	1460	1420	1020	990
	+40°C	1550	1545	1610	1580	1140	1105
Maximum Pressure psi (bar)	9.0 (0.6)	5.5 (0.4)	14.5 (1.0)	10.5 (0.7)	43.4 (3.0)	32 (2.2)	
Maximum Flow gpm (l/min)	3.9 (14.8)	3.4 (12.9)	3.5 (13.2)	3.1 (11.7)	2.6 (9.8)	2.2 (8.3)	
Part Number 120 VAC/60 Hz	LS51M11A110C		LS51MX1A110C		LS51TX1A110C		
Part Number 240 VAC/50 Hz	LS52M21A110E		LS52MY1A110E		LS52TY1A110E		

1. Cooling Capacity based on 20°C (68°F) ambient temperature and a 50%/50% mix of ethylene glycol and distilled water as coolant. Electrical plugs for the part numbers listed are standard U.S. and European types. See page 128 for additional plug types and part numbers. See pages 124 and 125 for considerations when choosing a chiller.

## Economical Cooling for Rotary Evaporators

LS Series Chillers are capable of simultaneously cooling two or more benchtop rotary evaporators, and provide particularly efficient and economical cooling at temperatures between 0°C and +10°C. Their powerful heat removal capability, combined with a compact design, makes them ideal for any low temperature cooling application where bench space is limited. They can also be placed on a mobile cart accessory, below a bench.

# Benchtop Chillers – LM Series -10° to +30°C

## Key Specifications

Working Temperature:	-10° to +30°C
Temperature Stability:	±0.1°C
Cooling Capacity:	Up to 560 W @ 20°C
Reservoir Capacity:	0.7 gallons/2.65 liters
Overall Dimensions (L x W x H):	20 x 10 x 17" 50.8 x 25.4 x 43.2 cm



## Features:

- Optimized for high performance at low temperatures
- Ideal for benchtop rotary evaporators
- Large, easy to read LED display
- Space-saving design
- Cooling at ambient temperatures as high as 35°C
- Low flow shutoff and alarm, high and low temperature alarms
- Simple setup, operation, and maintenance
- Choice of pumps
- Fluid level indicator



Large, easy to read temperature display lets you check operation at a glance.



c 155859 US

Working Temperature Range		-10° to +30°C			
Temperature Stability		±0.1°C			
Pump Type		Centrifugal		Centrifugal	
		GX (60 Hz)	GY (50 Hz)	MX (60 Hz)	MY (50 Hz)
Cooling Capacity <sup>1</sup> @ (W)	-10°C	230	140	170	110
	0°C	350	250	250	170
	+10°C	470	390	340	280
	+20°C	560	520	420	390
	+30°C	650	600	540	500
Maximum Pressure psi (bar)		5.1 (0.35)	4.4 (0.3)	14.5 (1.0)	12.5 (0.9)
Maximum Flow gpm (l/min)		2.1 (7.9)	1.8 (6.8)	3.5 (13.2)	3.0 (11.4)
Part Number 120 VAC/60 Hz		LM61GX1A110C		LM61MX1A110C	
Part Number 240 VAC/50 Hz		LM62GY1A110E		LM62MY1A110E	

1. Cooling Capacity based on 20°C (68°F) ambient temperature and a 50%/50% mix of ethylene glycol and distilled water as coolant.

See pages 109 through 112 for LM Series Chiller options and accessories.

See pages 124 and 125 for considerations when choosing a chiller.

Electrical plugs for the part numbers listed are standard U.S. and European types. See page 128 for additional plug types and part numbers.

# Benchtop Chillers – MM Series -5° to +50°C

## Key Specifications

Working Temperature:	From -5° to +50°C
Temperature Stability:	±0.1°C
Cooling Capacity:	Up to 460 W @ 20°C
Reservoir Capacity:	0.7 gallons/2.65 liters
Overall Dimensions (L x W x H):	20 x 10 x 17" 50.8 x 25.4 x 43.2 cm



## Features:

- Precise and stable temperature control at low temperatures
- Large, easy to read LED display
- Space-saving, benchtop design
- Cooling at ambient temperatures as high as 35°C
- Low flow shutoff and alarm, high and low temperature alarms
- Simple setup, operation, and maintenance
- Choice of pumps
- Fluid level indicator



Reusable front-mounted air filter is easily accessible and provides energy efficient cooling.



c 155859 US

Working Temperature Range		-5° to +50°C			
Temperature Stability		±0.1°C			
Pump Type		Centrifugal		Centrifugal	
		GX (60 Hz)	GY (50 Hz)	MX (60 Hz)	MY (50 Hz)
Cooling Capacity <sup>1</sup> @ (W)	-5°C	130	115	115	105
	0°C	215	190	195	175
	+10°C	320	290	305	270
	+20°C	460	410	435	390
	+40°C	520	470	505	450
	+50°C	550	495	535	480
Maximum Pressure psi (bar)		5.1 (0.4)	4.4 (0.3)	14.5 (1.0)	12.5 (0.9)
Maximum Flow gpm (l/min)		2.1 (7.9)	1.8 (6.8)	3.5 (13.2)	3.0 (11.4)
Part Number 120 VAC/60 Hz		MM71GX1A110C		MM71MX1A110C	
Part Number 240 VAC/50 Hz		MM72GY1A110E		MM72MY1A110E	

1. Cooling Capacity based on 20°C (68°F) ambient temperature and a 50%/50% mix of ethylene glycol and distilled water as coolant.

See pages 109 through 112 for MM Series Chiller options and accessories.

See pages 124 and 125 for considerations when choosing a chiller.

Electrical plugs for the part numbers listed are standard U.S. and European types. See page 128 for additional plug types and part numbers.

# Portable Chillers – 6000 Series – ¼ to 1 HP

## Key Specifications

Working Temperature:	-10° to +40°C, -10° to +70°C with heater option
Temperature Stability:	±0.1°C
Cooling Capacity:	Up to 2900 W @ 20°C
Reservoir Capacity:	1.1 gallons/4.2 liters
Overall Dimensions (L x W x H):	27.6 x 14.5 x 22.6" 70.2 x 36.8 x 57.5 cm



## Features:

- Stable and reliable cooling for many common heat removal applications, including laser etching, AA furnaces, ICP, rotary evaporators, vacuum systems, reaction vessels, plasma etching, and condenser cooling
- Large, dual displays present temperature and pressure or flow rate simultaneously
- Compact, portable design takes up less floor space
- Cooling at ambient temperatures as high as 35°C
- Choice of pumps and compressor sizes
- User-adjustable temperature, pressure, and flow rate alarms
- Heater option extends cooling temperature to +50°C, provides the ability to apply heat up to 70°C; ideal for applications, such as lasers, that must be brought to a temperature above ambient before operation can begin
- External temperature tracking and communications capability (optional)
- Cool Command™, WhisperCool™ (3/4 and 1 HP models)



C 155859 US



Large digital readouts provide information on temperature as well as the process flow rate or pressure at a glance.

See pages 124 and 125 for considerations when choosing a chiller.

## 6000 Series Chillers with Turbine Pump

	6200 1/4 HP		6300 1/3 HP		6500 1/2 HP		6700 3/4 HP		6100 1 HP	
Temperature Range	-10° to +40°C (-10° to +70°C with heater option)									
Temperature Stability	±0.1°C									
Cooling Capacity <sup>1</sup> @ (W)	400 600 850	300 500 700	530 990 1400	485 935 1280	750 1150 1700	765 1140 1775	875 1550 2300	975 1500 2200	1000 1925 2900	1200 1900 2650
Maximum Pressure psi (bar)	100 (6.9)	83 (5.7)	100 (6.9)	83 (5.7)	100 (6.9)	83 (5.7)	100 (6.9)	83 (5.7)	100 (6.9)	83 (5.7)
Maximum Flow gpm (l/min)	3.5 (13.2)	2.9 (11)	3.5 (13.2)	2.9 (11)	3.5 (13.2)	2.9 (11)	3.5 (13.2)	2.9 (11)	3.5 (13.2)	2.9 (11)
Power Requirements (V/Hz)	120/60	240/50	120/60	240/50	120/60	240/50	208-230/60	240/50	208-230/60	240/50
Part Number 120 VAC/60 Hz	6260T11A110B		6360T11A120C		6560T11A120C		6760T21A130D		6160T21A130D	
Part Number 240 VAC/50 Hz	6250T21A130E		6350T21A130E		6550T21A130E		6750T21A130E		6150T21A130E	

## 6000 Series Chillers with Positive Displacement Pump

	6200 1/4 HP		6300 1/3 HP		6500 1/2 HP		6700 3/4 HP		6100 1 HP	
Temperature Range	-10° to +40°C (-10° to +70°C with heater option)									
Temperature Stability	±0.1°C									
Cooling Capacity <sup>1</sup> @ (W)	400 600 850	300 500 700	530 990 1400	485 935 1280	750 1150 1700	765 1140 1775	875 1550 2300	975 1500 2200	1000 1925 2900	1200 1900 2650
Maximum Pressure psi (bar)	100 (6.9)	83 (5.7)	100 (6.9)	83 (5.7)	100 (6.9)	83 (5.7)	100 (6.9)	83 (5.7)	100 (6.9)	83 (5.7)
Maximum Flow gpm (l/min)	1.0 (3.8)	0.95 (3.6)	1.0 (3.8)	0.95 (3.6)	1.0 (3.8)	0.95 (3.6)	3.5 (13.2)	2.9 (11)	3.5 (13.2)	2.9 (11)
Power Requirements (V/Hz)	120/60	240/50	120/60	240/50	120/60	240/50	208-230/60	240/50	208-230/60	240/50
Part Number 120 VAC/60 Hz	6260P11A110B		6360P11A120C		6560P11A120C		6760P41A130D		6160P41A130D	
Part Number 240 VAC/50 Hz	6250P21A130E		6350P21A130E		6550P21A130E		6750P41A130E		6150P41A130E	

## 6000 Series Chillers with Magnetic Drive Centrifugal Pump

	6200 1/4 HP		6300 1/3 HP		6500 1/2 HP		6700 3/4 HP		6100 1 HP	
Temperature Range	-10° to +40°C (-10° to +70°C with heater option)									
Temperature Stability	±0.1°C									
Cooling Capacity <sup>1</sup> @ (W)	300 700 950	400 600 800	700 1000 1430	600 960 1180	850 1250 1800	765 1140 1775	975 1550 2350	1075 1600 2250	1100 1835 2900	1400 2050 2750
Maximum Pressure psi (bar)	10 (.69)	9.5 (0.66)	10 (.69)	9.5 (.66)	10 (.69)	9.5 (.66)	10 (.69)	9.5 (.66)	10 (.69)	9.5 (.66)
Maximum Flow gpm (l/min)	4.1 (15.5)	3.9 (14.7)	4.1 (15.5)	3.9 (14.7)	4.1 (15.5)	3.9 (14.7)	4.1 (15.5)	3.9 (14.7)	4.1 (15.5)	3.9 (14.7)
Power Requirements (V/Hz)	120/60	240/50	120/60	240/50	120/60	240/50	208-230/60	240/50	208-230/60	240/50
Part Number 120 VAC/60 Hz	6260M11A110B		6360M11A110B		6560M11A120C		6760M21A130D		6160M21A130D	
Part Number 240 VAC/50 Hz	6250M21A130E		6350M21A130E		6550M21A130E		6750M21A130E		6150M21A130E	

1. Cooling Capacity based on 20°C (68°F) ambient temperature and a 50%/50% mix of ethylene glycol and distilled water as coolant

See pages 109 through 112 for 6000 Series Chiller options and accessories.

Electrical plugs for the part numbers listed are standard U.S. and European types. See page 128 for additional plug types and part numbers.

# Portable Chillers – DuraChill™ 6860 - 1.5 HP

## Key Specifications

Working Temperature: +5° to 35°C

Temperature Stability: ±0.5°C

Cooling Capacity: Up to 6,328 W @ 20°C

Reservoir Capacity: 3.5 gallons/13.25 liters

Overall Dimensions 30.5 x 19 x 26"

(L x W x H): 78 x 48 x 66 cm



## Features:

- High capacity cooling for lasers, electron microscopes, and other laboratory applications
- Small footprint conserves floor space
- Displays temperature and pressure or flow rate simultaneously
- User-adjustable temperature, pressure, and flow rate alarms
- Simple operation and low maintenance
- Wide variety of options available

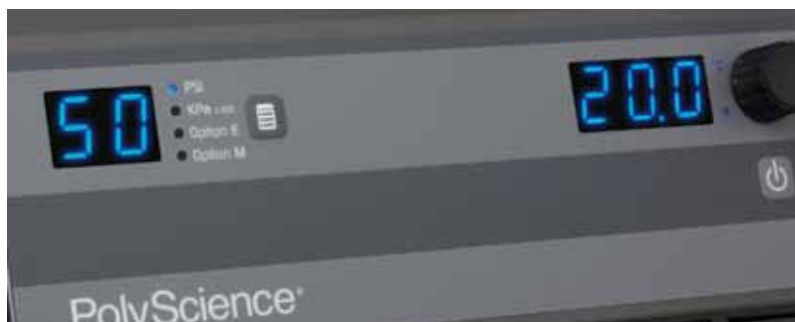

Dual displays provide ready access to both temperature and process pressure/flow rate information.



C 155859 US

	Air Cooled 1.5 HP		Water Cooled 1.5 HP	
Temperature Range	41° to 95°F/5° to 35°C			
Temperature Stability	±0.9°F/±0.5°C			
Power Requirements <sup>1</sup> (VAC/Hz/PH)	230/60/1	240/50/1	230/60/1	240/50/1
Cooling Capacity <sup>2</sup> @ 20°C (W/BTU)	5,200/17,732	4,576/15,604	6,328/21,578	5,569/18,990
Standard Pump	1/4 HP Positive Displacement			
Maximum Pressure psi (bar)	100 (6.9)	83 (5.7)	100 (6.9)	83 (5.7)
Maximum Flow gpm (l/min)	3.5 (13.2)	2.9 (11)	3.5 (13.25)	2.9 (11)
Part Number 230 VAC/60 Hz	6860P46A270D		6960P46A270D	
Part Number 240 VAC/50 Hz	6850P46A270E		6950P46A270E	

1. 220/50/3, 230/60/3, 460/60/3, and 380/50/3 also available.

2. Cooling capacity based on 20°C/68°F entering air and 20°C/68°F leaving water. Allowance made for heat gain from pump. Electrical plugs for the part numbers listed are standard U.S. and European types. See page 128 for additional plug types and part numbers. DuraChill™ Chillers are available with a wide selection of factory installed options. Contact us for help in selecting the chiller size and configuration that best meets your heat removal requirements. See pages 109 through 112 for DuraChill™ options and accessories.



# Portable Chillers – DuraChill™ – 2 to 3 HP

## Key Specifications

Working Temperature: +5° to 35°C

Temperature Stability: ±0.5°C

Cooling Capacity: Up to 10,936 W @ 20°C

Reservoir Capacity: 7 gallons/26.5 liters

Overall Dimensions (L x W x H): 30.5 x 37 x 42"  
78 x 94 x 107 cm



## Features:

- High capacity cooling for lasers, EDM equipment, injection molding, and other heat removal applications
- Displays temperature and pressure or flow rate simultaneously
- User-adjustable temperature, pressure, and flow rate alarms
- Easy to operate and maintain



	Air Cooled 2.0 HP		Air Cooled 3.0 HP		Water Cooled 3.0 HP	
Temperature Range	41° to 95°F/5° to 35°C					
Temperature Stability	±0.9°F/±0.5°C					
Power Requirements <sup>1</sup> (VAC/Hz/PH)	240/60/3	220/50/3	240/60/3	220/50/3	240/60/3	220/50/3
Cooling Capacity <sup>2</sup> @ 20°C (W/BTU)	7,000/ 23,870	6,160/ 21,006	10,500/ 35,805	9,240/ 31,508	10,936/ 37,292	9,624/ 32,817
Standard Pump	1/3 HP Centrifugal					
Maximum Pressure psi (bar)	20.5 (1.41)	17.1 (1.2)	20.5 (1.41)	17.1 (1.2)	20.5 (1.41)	17.1 (1.2)
Maximum Flow gpm (l/min)	12 (45.1)	10 (37.6)	12 (45.1)	10 (37.6)	12 (45.1)	10 (37.6)

1. 230/60/1, 460/60/3, 240/50/1, and 380/50/3 also available.

2. Cooling capacity based on 20°C/68°F entering air and 20°C/68°F leaving water. Allowance made for heat gain from pump. DuraChill™ Chillers are available with a wide selection of factory installed options. Contact us for help in selecting the chiller size and configuration that best meets your heat removal requirements. See pages 109 through 112 for DuraChill™ options and accessories.

# Portable Chiller – DuraChill™ – 5 to 10 HP

## Key Specifications

Working Temperature: 0° to 30°C





Temperature Stability: ±1.11°C

Cooling Capacity: Up to 33,436 W @ 35°C Ambient



## Features:

- High capacity cooling for plasma torch cutting, machine tool hydraulics, high powered lasers, and other high heat generating processes and equipment
- Displays temperature and pressure or flow rate simultaneously
- User-adjustable temperature, pressure, and flow rate alarms
- Easy to operate and maintain
- Wide variety of options available

	 Air Cooled 5.0 HP		Air Cooled 7.5 HP		Air Cooled 10.0 HP	
Temperature Range	32° to 86°F/ 0° to 30°C					
Temperature Stability	±2.0°F/±1.11°C					
Power Requirements <sup>1</sup> (VAC/Hz/PH)	240/60/3	220/50/3	460/60/3	380/50/3	460/60/3	380/50/3
Cooling Capacity <sup>2</sup> @ 35°C ambient (W/BTU)	16,384/ 55,869	14,418/ 50,515	22,361/ 76,251	19,678/ 67,102	33,436/ 114,016	29,424/ 100,336
Standard Pump	1 HP Centrifugal				2 HP Centrifugal	
Maximum Pressure psi (bar)	40 (2.8)	33 (2.3)	40 (2.8)	33 (2.3)	55 (3.8)	46 (3.2)
Maximum Flow gpm (l/min)	50.2 (190)	42 (158)	50.2 (190)	42 (158)	64.7 (245)	53 (200)
Reservoir Capacity (gallons/liters)	16/60.5			45/170		
Overall Dimensions (L x W x H)	56 x 34.5 x 67" (142.2 x 88 x 170.2 cm)				77 x 34.5 x 68.2" (195.5 x 88 x 173.2 cm)	

1. 575/60/3 also available.

2. Cooling capacity based on 35°C/95°F entering air, 49°C/120°F condensing temperature, and 10°C/50°F leaving water. Allowance made for heat gain from pump.

DuraChill™ Chillers are available with a wide selection of factory installed options. Contact us for help in selecting the chiller size and configuration that best meets your heat removal requirements. See pages 109 through 112 for DuraChill™ options and accessories.

# Recirculating Coolers – Model 3370 Liquid-to-Air Cooler

## Key Specifications

Working Temperature Range:	Ambient +5 to 70°C
Maximum Fluid Temperature:	70°C
Cooling Capacity:	4000 W based on 11°C $\Delta T^1$ (water)
Reservoir Capacity:	1.1 gallons/4.2 liters
Overall Dimensions (L x W x H):	20.5 x 15 x 22.3" 52 x 38.1 x 56.6 cm



## Features:

- An economical cooling solution for applications where cooling fluid temperature is higher than ambient and temperature control is not required
- Quiet liquid-to-air cooling
- Positive displacement or turbine pump
- Built-in low liquid level indicator

Liquid-to-air cooling uses ambient air to cool your application. Heated process fluid is pumped through the 3370's fan-cooled heat exchanger and returned to the process.



Front-mounted gauge lets you check process pressure at a glance.



C 155859 US

Temperature Range	Ambient to 70°C			
Cooling Capacity @ 20°C (W)	500 based on 2°C $\Delta T^1$ 1000 based on 4°C $\Delta T^1$ 2000 based on 8°C $\Delta T^1$ 3000 based on 10°C $\Delta T^1$ 4000 based on 11°C $\Delta T^1$			
Power Requirements (V/Hz)	120/60	240/50	120/60	240/50
Pump	1/3 HP Positive Displacement		1/3 HP Turbine Pump	
Maximum Pressure psi (bar)	100 (6.9)	100 (6.9)	62 (4.3)	50 (3.4)
Maximum Flow gpm (l/min)	2.4 (9.1)	2 (7.6)	5.4 (20.5)	4.5 (17.1)
Part Number 120 VAC/60 Hz	3370P9A11B		3370TBA11B	
Part Number 240 VAC/50 Hz	3370P9A12E		3370TBA12E	

1.  $\Delta T$  = Process water temperature – ambient air temperature

See pages 124 and 125 for considerations when choosing a chiller.

Electrical plugs for the part numbers listed are standard U.S. and European types. See page 128 for additional plug types and part numbers.

# Recirculating Coolers – Model 4100 Liquid-to-Liquid Cooler

## Key Specifications

Working Temperature Range:	Facility water +10° to 60°C
Maximum Process Temperature:	60°C
Temperature Stability:	±0.4°C
Cooling Capacity:	10,000 W based on 10°C $\Delta T^1$
Reservoir Capacity:	1.1 gallons/4.2 liters
Overall Dimensions (L x W x H):	27.6 x 14.5 x 22.6" 70.2 x 36.8 x 57.5 cm



## Features:

- Protects precision equipment from facility water contaminants
- Quiet, energy efficient liquid-to-liquid heat removal
- Displays temperature and pressure or flow rate information
- Built-in temperature and low flow alarms

Liquid-to-liquid cooling uses your facility's water, pumped through the 4100, to remove heat from your application without risk of contamination. Heat removal capacity is dependent on the facility water temperature.

Larger capacities are available. Contact PolyScience Customer Service Department for more information.



Extra large digital readouts provide at a glance access to temperature as well as process pressure or flow rate information.



C 155859 US

Temperature Range	Facility water +10° to 60°C
Cooling Capacity (W/BTU)	15,000/52,855 based on 15°C $\Delta T^1$ 10,000/34,100 based on 10°C $\Delta T^1$ 4,500/5,345 based on 5°C $\Delta T^1$
Power Requirements (VAC/Hz)	200-240/ 50/60 (plug for 230V)
Standard Pump	Turbine Pump
Maximum Pressure psi (bar)	100 (6.9)
Maximum Flow gpm (l/min)	3.5 (13.2)
Part Number 200-240 VAC/50/60 Hz	4150T21A330D

1.  $\Delta T$  = Process water temperature – facility water air temperature

Electrical plug for the part number listed is standard U.S. type. See page 128 for additional plug types and part numbers.

Specifications listed are for 60 Hz models. For specifications on 50 Hz models see Technical Specification pages 150 and 151.

# Factory Installed Chiller Options

Description	Benchtop Chillers	6000 Series Chillers	Non-Refrigerated Coolers
Heater		O	
RS232 Communication	O	O	O
RS485 Communication		O	O
Remote On/Off (24 VDC)		O	O
Remote On/Off (Dry Contact)		O	O
External Temperature Tracking		O	O
Deionized Water Compatible		O	
Stainless Steel Reservoir		O	
No Reservoir		O	
External Water Filter	O	O	O
Reservoir Level Switch/Alarm		O	

FACTORY INSTALLED OPTIONS: DURACHILL™ CHILLERS	Air-Cooled				Water-Cooled	
	1.5 HP 6800 Series	2 HP/3 HP DCA200/300	5 HP/7.5 HP DA500/750	10 HP DA1000	1.5 HP 6900 Series	3 HP DCW300
RS232 Communications Port	O	S	S	S	O	S
RS485 Communications Port	O	O	O	O	O	O
Remote On/Off (24 VDC)	O	O	O	O	O	O
Remote On/Off (Dry Contact)	O	S	S	S	O	S
Alarm Output (Dry Contact)	O	S	S	S	O	S
High or Low Ambient Tracking Package	O				O	
Deionized Water Compatibility Package	O	O	O	O	O	O
Process Fluid Shut-Off Valves		O	O	O		O
Low Fluid Level Shut-Off Switch	O	O	O	O	O	O
No Reservoir	O	O	O	O	O	O
Stainless Steel Reservoir	O	O	O	O	O	O
Process Heater	O	O	O	O	O	O
<b>PUMPS</b>						
0.75 HP Stainless Steel or Bronze Turbine	O	O			O	O
1.0 HP Stainless Steel Turbine	O				O	
1.5 HP Bronze Turbine		O	O			O
2.0 HP Bronze Turbine		O	O			O
3.0 HP Bronze Turbine		O	O	O		O
5.0 HP Bronze Turbine				O		
2.33 gpm Brass Positive Displacement	O				O	
3.5 gpm Brass Positive Displacement	S				S	
0.10 gpm GF Polypropylene Magnetic Drive Centrifugal	O				O	
0.75 HP Stainless Steel Centrifugal		S				S
1.0 HP Stainless Steel Centrifugal		O	S			O
2.0 HP Stainless Steel Centrifugal		O	O	S		O
3.0 HP Stainless Steel Centrifugal		O	O	O		O
No Pump	O	O	O	O	O	O

S = Standard

O = Available As Option

Additional options may be available.

These options should be ordered with your chiller. Most cannot be field-installed.  
See page 127 for DuraChill™ Factory Installed Option descriptions.

# Chiller Fluids

Fluid Type	Name	Description	Temperature Range	Benchtop Chillers	6000 Series Chiller	DuraChill™ Chillers	Non-Refrigerated Coolers	Quantity	Part Number
Cleaners	polyclean ALGAECIDE	Prevents growth of algae, keeps reservoir clean and odor-free. Concentrated: 8 oz (237 ml) treats approximately 200 gallons (757 liters)	n/a	•	•	•	•	8 oz (237 ml)	004-300040
								case = 12 x 8 oz (237 ml)	004-300041
Low Temperature Fluids	polycool HC -50	Excellent low-temperature performance without toxicity or risk to environment, equipment, or personnel. Provides low-temp properties of synthetic organic and silicone fluids with thermal properties of water-based glycols.	-50° to 100°C (-58° to 148°F)	•	•	•	•	1 gallon (3.8 L)	060330
	polycool EG -25	A common chiller antifreeze fluid. Lowers the freezing point of water to allow circulation at below freezing temperatures. Recommend mixing with distilled water for broadest temperature range.	-25° to 100°C (-13° to 212°F) when mixed 50%/50% with distilled water	•	•	•	•	1 gallon (3.8 L)	060340
	polycool PG -20	Propylene glycol is a safer alternative to ethylene glycol. Lowers freezing point of water to allow circulation at below freezing temperatures. Mix with distilled water for broadest temperature range.	-20° to 100°C (-4° to 212°F) when mixed 50%/50% with distilled water	•	•	•	•	1 gallon (3.8 L)	060320
Fluid Mixes	polycool MIX -25	Optimizes performance in refrigerated products; protects against freezing and algae growth.	-25° to 100°C (-13° to 212°F)	•	•	•	•	case = 5 x 1/2 gallon (1.9 L)	004-300060
	polyclear MIX 30	General purpose fluid for routine applications above 15°C; prevents algae growth.	15° to 90°C (59° to 194°F)		•		•	case = 5 x 1/2 gallon (1.9 L)	004-300062

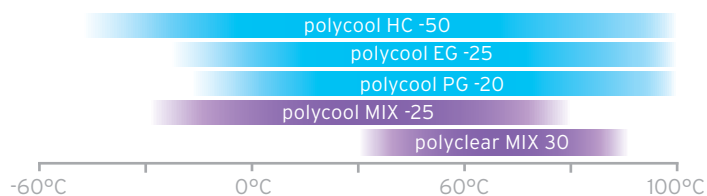

# Chiller Accessories

Description	L-Series Chillers	M-Series Chillers	6000 Series Chillers	DuraChill™ Chillers	Model 4100 Liquid-to-Liquid Coolers	Quantity	Part Number
<b>TEMPERATURE MEASUREMENT</b>							
Ambient Temperature Sensor			•	•	•	1 each	510-299
External PT100 Probe, 10' cable (3 m)			•	•	•	1 each	060101
External PT100 Probe, 25' cable (7.6 m)			•	•	•	1 each	060105
External PT100 Probe, 50' cable (15 m)			•	•	•	1 each	060110
<b>FLUID FILTERS</b>							
Filter Housing with bracket (Sediment Filters sold separately)			•	•		1 each	510-751
30 micron Sediment Filter (package of 2)			•	•		1 pack	775-848
20 micron Sediment Filter (package of 2)			•	•		1 pack	775-719
5 micron Sediment Filter (package of 2)			•	•		1 pack	775-846
50 micron Filter Kit with housing and bypass	•	•				1 each	510-520
50 micron Filter Kit with housing (no bypass)	•	•				1 each	510-519
<b>MOBILITY</b>							
Base with locking casters	•					1 each	505-169
<b>BYPASS VALVE KITS</b>							
External Pressure Reducer for chillers with Positive Displacement or Turbine pumps. Reduces chiller output to adjustable range of 10-45 psi (0.69-3.10 bar)			•			1 each	060302
External bypass for chillers with magnetic drive centrifugal pump. Connects to inlet and outlet, allowing bypass flow when application flow is stopped.			•			1 each	510-147
<b>COMMUNICATION</b>							
RS232 Retrofit Kit: Includes hardware, installation and operation instructions.			•			1 each	510-298



# Chiller Accessories

Description	L-Series Chillers	M-Series Chillers	6000 Series Chillers	Model 4100 Liquid-to-Liquid Cooler	Model 3370 Liquid-to-Air Cooler	Quantity	Part Number
<b>TUBING/INSULATION/CLAMPS/FITTINGS/MANIFOLDS</b>							
Tubing. Select by temperature range. Order in continuous length, multiples of 1 m (39").							
Buna N Tubing (synthetic rubber), 1/2" (13 mm) -40 to 120°C	•	•	•	•	•	1 m (39")	060308
Viton® Tubing, 1/2" (13 mm) -32 to 200°C	•	•	•	•	•	1 m (39")	060316
Viton® Tubing, 5/8" (16 mm) -32 to 200°C			•	•	•	1 m (39")	060317
Viton® Tubing, 3/4" (19 mm) -32 to 200°C			•	•	•	1 m (39")	060318
Viton® Tubing, 3/8" (10 mm) -32 to 200°C	•	•	•	•	•	1 m (39")	060319
Insulation for all 1/2" (13 mm) tubing above, 1 m (39") lengths only	•	•	•	•		1 m (39")	060311
Tube Clamp for 1/2" (13 mm), 5/8" (16 mm), 3/4" (18 mm) OD tubing	•	•	•	•	•	1 each	400-898
<b>FITTINGS/ADAPTERS</b>							
Fitting, 1/2" male NPT to 3/8" (9.5 mm), hose barb, brass, straight	•	•	•	•	•	1 each	776-196
Fitting, 1/2" male NPT to 3/8" (9.5 mm), hose barb, brass, elbow	•	•	•	•	•	1 each	775-047
Fitting, 1/2" male NPT x 5/8" (16 mm) hose barb, nylon, straight	•	•	•	•	•	1 each	300-131
Fitting, 1/2" male NPT x 1/2" (13 mm) hose barb, nylon, straight	•	•	•	•	•	1 each	300-096
Fitting, 1/2" male NPT to 3/4" (19 mm), hose barb, brass, straight	•	•	•	•	•	1 each	776-197
Fitting, 1/2" male NPT to M16x1 13 mm (1/2"), brass, straight	•	•	•	•	•	1 each	775-048
Manifold Kit, 2 ports with shutoffs	•	•	•	•	•	1 each	510-665
Manifold Kit, 4 ports with shutoffs	•	•	•	•	•	1 each	510-664



AIR FILTERS	Quantity	Part Number
For LM and MM Benchtop	1 each	750-798
For LS Benchtop	1 each	750-758
For 6000 Series, Model 3370, IP-100, IP-80	1 each	750-855
For 1.5 HP	1 each	750-387
For 2 and 3 HP	1 each	305-033
For 5 HP	1 each	400-598
For 7.5 HP	1 each	400-599
For 10 HP	1 each	750-264





# Low Temperature Coolers

Two simple ways to chill.

Enhance and simplify your low-temperature laboratory work with a PolyScience Low Temperature Cooler. Available in both immersion probe and flow-through styles, they provide rapid, low-cost cooling of liquids to temperatures as low as  $-100^{\circ}\text{C}$ . Typical applications include the cooling of exothermic reactions, freeze point determinations, freeze drying, impact testing, lyophilization, and vapor and solvent trapping.

- **Immersion Probe Style Coolers**

Excellent for trapping and Dewar-type applications and reduce the expense of using dry ice or liquid nitrogen. A flexible hose allows convenient placement of the cooling probe.

- **Flow-through Style Coolers**

Extend the temperature range of non-refrigerated circulators to below ambient and boost the cooling capacity of refrigerated circulators. These coolers also offer an extremely economic alternative to the tap water cooling of heated circulating baths when rapid cool-downs or operation at or near ambient is needed.



# Low Temperature Coolers – Immersion Probe

## Key Specifications

	IP-100	IP-80	IP-60	IP-35
Temperature Range:	-100° to -60°C	-80° to -40°C	-60° to -20°C	-35° to +40°C
Cooling Capacity:	85 W at -65°C 35 W at -80°C	150 W @ -60°C 85 W @ -80°C	75 W at -20°C 0 W at -60°C	1004 W at 20°C 106 W at -30°C
Temperature Control:	Fixed at -100°C	Fixed at -80°C	Fixed at -60°C	Fixed at -35°C
Temperature Readout:	Yes	Yes	No	No



## Features:





- Continuous cooling to temperatures as low as -100°C
- Designed to run at maximum cooling
- An economical alternative to dry ice or liquid nitrogen
- Excellent for trapping applications, freeze drying, and rapidly cooling small volumes of liquids



### Immersion Probe Dimensions

	Insulated Flexible Hose	Rigid Coil Probe (3")	Rigid Coil Probe (1.5")	Rigid Coil Probe (1.75")	Rigid Cold Finger Probe	Flexible Cold Finger Probe
Model	IP-100, IP-80, IP-60, IP-35	IP-100, IP-35	IP-80, IP-60	IP-35	IP-100	IP-100
Diameter	IP-100, IP-80: 2.83"/7.14 cm IP-60, IP-35: 1.5"/3.81 cm	3"/7.62 cm	1.5"/3.81 cm	1.75"/4.44 cm	0.75"/1.91 cm	0.625"/1.59 cm
Length	IP-100, IP-80: 6'/1.83 m IP-60, IP-35: 4'/1.22 m	Coil: 9"/22.9 cm Exposed: 17"/43.2 cm	Coil: 4"/10.2 cm Exposed: 15"/38.1 cm	Coil: 7"/17.8 cm Exposed: 16.5"/41.9 cm	3.75"/9.53 cm	15 /38.1 cm



IP-100	IP-80	IP-60	IP-35
<p>Temperature Range: -100° to -60°C</p> <p>Probe: Rigid Coil (3"/7.62 cm), Cold Finger, or Flexible</p> <p>Overall Dimensions: (L x W x H) 20.1 x 15 x 22.3" 51.1 x 38.1 x 56.6 cm</p> <p>Rigid Coil Part Number: 120 VAC/60 Hz: P10N6A101B 240 VAC/60 Hz: P10N6A102E</p> <p>Rigid Cold Finger Part Number: 120 VAC/60 Hz: P10N3A101B 240V/60Hz: P10N3A102E</p> <p>Flexible Cold Finger Part Number: 120 VAC/60 Hz: P10N4A101B 240 VAC/60 Hz: P10N4A102E</p>  <p>C 155859 US</p>	<p>Temperature Range: -80° to -40°C</p> <p>Probe: Rigid Coil (1.5"/3.81 cm)</p> <p>Overall Dimensions: (L x W x H) 20.1 x 15 x 22.3" 51.1 x 38.1 x 56.6 cm</p> <p>Part Number: 120 VAC/60 Hz: P80NHA101B 240 VAC/50 Hz: P80NHA102E</p>  <p>C 155859 US</p>	<p>Temperature Range: -60° to -20°C</p> <p>Probe: Rigid Coil (1.5"/3.81 cm)</p> <p>Overall Dimensions: (L x W x H) 11 x 10 x 9" 27.9 x 25.4 x 22.9 cm</p> <p>Part Number: 120 VAC/60 Hz: P60N2A101B 240 VAC/60 Hz: P60N2A102E</p> 	<p>Temperature Range: -35° to +40°C</p> <p>Probe: Rigid Coil (1.75"/4.44 cm or 3"/7.62 cm)</p> <p>Overall Dimensions: (L x W x H) 17 x 14 x 14" 43.2 x 35.6 x 35.6 cm</p> <p>1.75" Rigid Coil Part Number: 120 VAC/60 Hz: P40N7A101B 240 VAC/50 Hz: P40N7A102E</p> <p>3" Rigid Coil Part Number: 120 VAC/60 Hz: P35N5A101B 240 VAC/50 Hz: P35N5A102E</p> 

Electrical plugs for the part numbers listed are standard U.S. and European types. See page 128 for additional plug types and part numbers.

## FT Series Flow Through Cooler

### Key Specifications

Temperature Range: -25° to +40°C

Cooling Capacity: 745 W at 20°C  
260 W at -10°C

Temperature Control: Fixed at -25°C

Inlet and Outlet Size: 3/8"/9.5 mm

Dimensions: 17 x 14 x 14"  
(L x W x H) 43.2 x 35.6 x 35.6 cm

**Part Number:**  
120 VAC/60 Hz **F25NOA101B**  
240 VAC/50 HZ **F25NOA102E**



## Features:

- Continuous cooling to -25°C
- Designed to run at maximum cooling
- Ideal for use with heated and refrigerated circulating baths

Temperature control must be provided by an external circulator; an anti-freeze solution is required in the circulating system.



Electrical plugs for the part numbers listed are standard U.S. and European types. See page 128 for additional plug types and part numbers.

At PolyScience, we believe strongly in providing the very best products and the highest level of service to our customers. While we have tried to provide adequate product descriptions, features and explanations throughout our catalog, we realize that some customers may be interested in more in-depth information than that listed in the product pages. Additionally, some customers may not be familiar with the language and terminology used.

The following pages provide explanations of many of the features that are listed within this catalog along with some guidance on selecting the best product for your application, performance curves, detailed specifications for each product listed, and additional information about our Company's services. If you do not find the information you are seeking please contact our Customer Service and Sales Department; they will be happy to answer any questions you might have, and assist you in selecting the product best suited to the needs of your application.

## Glossary

### Air-Cooled (Chiller)

A type of chiller that exhausts the heat absorbed from the process to the surrounding air. Most of the chillers listed in the catalog are air-cooled (unless otherwise specified). The cooling efficiency of air-cooled chillers is directly related to ambient air temperature.

### Ambient Air Temperature

The temperature of the room in which the Circulator, Chiller, etc., is located. Refrigerated equipment is generally required when the application temperature must be controlled near or below the ambient room temperature.

### Ambient Temperature Range

This represents the highest and lowest ambient air temperatures at which the Circulator or Chiller was designed to operate.

### Calibration Capability

The ability to match the reading of a device to that of a known standard or another device. PolyScience Circulators, Chillers, and Digital General Purpose Water Baths all feature calibration capability.

### Centrifugal Pump (magnetic drive)

Available on many PolyScience Recirculating Chillers, this type of pump provides higher relative flow rates at lower pressures and is suitable for applications that are in close proximity to the chiller or require lower pressure. Centrifugal pumps are generally more sensitive to pressure drops than other types of pumps.

### Chiller/Recirculating Chiller

A closed-loop refrigerated system designed to cool an external device. In general, Chillers have more cooling capacity and are capable of higher flow rates and higher fluid pressures than can be achieved by Refrigerated Circulators.

### Circulator/Circulating Bath

A general term referring to a category of temperature control devices. See Refrigerated/Heated Circulating Bath, Heated Circulating Bath, and Immersion Circulator.

### Closed-Loop Circulation

This is generally used in reference to systems or applications where liquid is pumped from a Chiller or Circulating Bath through an external device such as a laser and then returned directly to the Chiller or Circulating Bath. Such systems are "closed" to the atmosphere. Closed-loop circulation may be achieved with both pressure only Simplex and pressure/suction Duplex pumps. All PolyScience Circulating Baths and Chillers are capable of closed-loop circulation.

### Cool Command™

A modulated refrigeration system that allows refrigeration to be activated at higher temperatures, providing faster cool downs and optimizing energy efficiency.

### Cooling Capacity

This is the amount of heat removal that a refrigerated device, such as a Chiller or Refrigerated Circulator, can provide at a given temperature. It is generally stated in watts or BTUs/hour. It may also be expressed in tons.

### Duplex Pump

A type of pump that provides both pressure and suction, making it suitable for both open-loop and closed-loop applications. PolyScience Circulating Baths with Performance and Advanced Series Controllers are equipped with Duplex pumps.

### DuraTop™

A precision molded phenolic top plate that remains cooler at high temperatures, is highly resistant to all but the strongest laboratory chemicals, and is easily cleaned and/or disinfected. DuraTop™ is standard on all PolyScience Circulating Baths, Open Tank Systems, Viscosity Baths, Calibration Baths, and both the Histology and Coliform Baths.

### **Flow-Through Cooler**

This auxiliary device is often used with open baths or heated Circulators when rapid cool down or operation at or near ambient temperature is required. A Flow-Through Cooler can also serve as a source of supplemental cooling when used in conjunction with a refrigerated Circulator or to add cooling to heated Circulators. Because a Flow-Through Cooler provides refrigeration only, an external pump or other source of circulation is required.

### **Flow Rate**

The volume of fluid pumped in a given amount of time. It is measured using water at a pressure of 0 psi (0.0 bar). Pressure Flow Rate is measured at the outlet port of the unit; Suction Flow Rate is measured at the inlet port.

### **General Purpose Water Bath**

A vessel that can be held at a desired temperature via an integral heater and temperature controller. A General Purpose Water Bath does not incorporate a mechanical means of fluid circulation.

### **Heat Exchanger**

A device used to transfer heat from one material or medium to another. Example: 3370 Liquid-to-Air Recirculator. May also be called a condenser or evaporator when used within a system.

### **Heat Load**

The amount of heat that is being generated by a device. Heat load calculations are generally used to determine the amount of heat removal needed to maintain the device at a desired temperature.

### **Heated Circulating Bath**

A bath with an integral pump, heater, and temperature controller. The circulation of fluid inside the bath reservoir results in better temperature stability and uniformity. All PolyScience Circulating Baths are capable of external circulation.

### **Immersion Circulator**

A combination integral pump, heater, and temperature controller that can be secured to a stand-alone tank or reservoir to form a complete Circulating Bath. The PolyScience MX Immersion Circulator can provide precise temperature control for tanks up to 28 liters.

### **Immersion Cooler**

An auxiliary device used to provide rapid cooling for small quantities of liquids or as a replacement for dry ice. An Immersion Cooler can also be used in conjunction with an open bath or heated Circulator to speed cool down or provide more precise control when operating at or near ambient temperature. Cooling is provided via a probe or cooling coil inserted directly in the liquid.

### **LidDock™**

An innovative design that provides for convenient, no-mess reservoir cover placement when adding liquid or working with samples. Available on PolyScience integrated Circulating Baths, the LidDock™ System allows condensate to drain back into the reservoir, yet doesn't interfere with controller viewing or operation.

### **Liquid-to-Air Recirculator/Heat Exchanger**

A closed-loop, non-refrigerated system designed to cool an external device by transferring its heat to the air via an integrated heat exchanger.

### **Liquid-to-Liquid Recirculator/Heat Exchanger**

A closed-loop, non-refrigerated system designed to cool an external device by transferring its heat to facility cooling water via an integrated heat exchanger.

### **Open-Loop Circulation**

This is generally used in reference to systems or applications where liquid is pumped from a Circulating Bath to an external open tank and then returned to the circulating bath. A Duplex pump (pressure/suction), such as that featured on PolyScience Circulating Baths with Performance and Advanced Series Temperature Controllers, is required for open-loop circulation.

### **OpenMode Programming**

Unique to PolyScience Performance Programmable Controllers, this feature places no restrictions on the number of time/temperature programs that can be stored or the number of steps a program can have. Limit is dependent on controller memory.

### **Operating Temperature Range**

This is the temperature range that the equipment is capable of achieving and may be broader than the Working Temperature Range. This extended temperature range is particularly useful for the cooling of devices – such as lasers – that must be brought up to a temperature above ambient before operation can begin.

# Glossary

## Positive Displacement Pump

Available on select PolyScience Recirculating Chillers, this type of pump generates moderate flow at high pressure. It is best suited for situations where greater head pressure is needed, such as applications where the cooling fluid must be pumped some distance or where in-line pressure is required to activate flow devices.

## Pump Pressure

The force of fluid being pumped. The higher the pressure, the greater the distance that the fluid can travel. Lower pressure is better for fragile fluid paths, such as glass tubing. It is measured using water at a flow rate of 0 gpm (0.0 l/min) at the outlet port of the unit.

## Recirculating Chiller

Interchangeable with Recirculator and Chiller:  
See "Chiller/Recirculating Chiller."

## Recirculating Cooler/Heat Exchanger

A closed-loop, non-refrigerated system designed to cool an external device. Cooling is provided by transferring heat from the external device to either the air (Liquid-to-Air Coolers) or to facility cooling water (Liquid-to-Liquid Coolers).

## Refrigerant

A compound used in a refrigeration unit to extract heat from a process or internal reservoir. All PolyScience Chillers and Refrigerated Circulators use CFC-free refrigerants.

## Refrigerated/Heated Circulating Bath

A bath with an integral pump, heater, refrigeration system, and temperature controller. In addition to low temperature applications, Refrigerated/Heated Circulating Baths offer more precise control for applications that require bath temperatures near or below ambient. All PolyScience Circulating Baths provide internal circulation as well as external circulation capability.

## Reservoir Capacity/Bath Volume

This specification provides information on how much liquid the Circulator, Water Bath, or Tank will hold when filled to maximum capacity. It does not include the volume of liquid in external tubing or equipment.

## Simplex Pump

A type of pump that provides pressure flow only, thus limiting its use to closed-loop applications. PolyScience Circulating Baths with Standard Digital and MX Temperature Controllers are equipped with Simplex pumps.

## SmartTouch Display

An advanced, full-color touch screen display. Featured on PolyScience Performance Programmable, Advanced Programmable, and Performance Digital Temperature Controllers.

## Specific Heat

This is a measure of a fluid's heat capacity (the amount of heat per unit mass required to raise its temperature by 1°). The specific heat of water is 1 BTU/lb °F (4.19 KJ/kg K). PolyScience Circulators with Performance and Advanced Series Temperature Controllers can be tuned for use with specific fluids to enhance performance and temperature control.

## Suction Pressure

This is the pressure generated by the pump at the fluid intake of a Circulator equipped with a Duplex (pressure/suction) pump. It is measured using water at a flow rate of 0 gpm (0.0 l/min).

## Swivel 180™ Rotating Controller

A (patent-pending) PolyScience exclusive that allows independent positioning of the Circulating Bath Temperature Controller, thus allowing the operator to keep the temperature display in sight anywhere within a 180° viewing radius. Swivel 180™ is standard on all Performance, Advanced, and Standard Temperature Controllers.

## Temperature Accuracy

This represents how well the instrument's measured temperature value corresponds to that of a calibrated standard. For example, the displayed bath temperature in a Circulating Bath with a set-point of 25.00°C and a temperature accuracy of ±0.25°C may actually be as low as 24.75°C or as high as 25.25°C. PolyScience Circulators, Digital Water Baths, and Chillers feature a calibration offset that allows the operator to match the displayed temperature to that of an external device or calibrated temperature standard.

### Temperature Stability

This represents how precisely an instrument maintains a set-point temperature and is expressed as a plus/minus value. For example, the actual bath temperature in a circulating bath with a set-point of 23.20°C and a temperature stability of  $\pm 0.01^\circ\text{C}$  may vary from 23.19°C to 23.21°C.

### Temperature Uniformity

This represents how closely liquid temperatures at various locations within the reservoir of the water bath match. In general, Circulating Baths provide better temperature uniformity than General Purpose Water Baths.

### Thermal Conductivity

This is a liquid, gas, or solid's ability to conduct heat. Water (with a thermal conductivity value of 0.6) is a good conductor of heat, while air (TC value of 0.025) is a much poorer heat conductor.

### Time/Temperature Programming

Standard on PolyScience Performance Programmable and Advanced Programmable Temperature Controllers, this feature allows the operator to create and store frequently used test protocols and/or complex ramp and soak profiles for later retrieval and use. The PolyScience Performance Programmable Controller features OpenMode Programming which has no set limits on the number of programs that can be stored or the number of steps in a program. Advanced Programmable Controllers can store up to ten 100-step programs.

### Thermal Loss/Thermal Gain

Also referred to as Heat Loss or Heat Gain, this is the change in temperature that may occur due to ambient temperature or other environmental conditions. Thermal loss/gain can be minimized through the use of a reservoir cover and by insulating external tubing. Select PolyScience Circulators and Chillers also feature external temperature control capability which can be used to compensate for heat loss/gain when circulating to external applications.

### Turbine Pump

Available on many PolyScience Recirculating Chillers, this type of pump provides moderate flow at higher pressures. It is well suited to applications that require higher pressure or experience a higher pressure drop, such as when using high viscosity fluids, smaller tubing diameters, or pumping higher or further from the cooling product and the application.

### Variable-speed Pump

Performance and Advanced Series Temperature Controllers are equipped with variable-speed pumps which allow adjustment of pump speed and flow rate throughout most of the range of the pump motor. This adjustability allows the user to compensate for fluid viscosity and achieve optimal uniformity within the bath. It also provides adjustment of flow rate when pumping to an external application.

### Viscosity

A measure of the resistance of a fluid to flow. The more viscous (thick) a fluid is, the more difficult it is to pump.

### Water Bath

A water bath refers to a heating, bath-style device used to thermoregulate temperature as a water bath, which could include Circulators. PolyScience uses this term to describe a "General Purpose Water Bath."

### Water-Cooled (Chiller)

A type of chiller that transfers heat absorbed from the process fluid to another liquid, such as facility water from a cooling tower, as opposed to transferring the heat to the ambient air. See also "Air-Cooled (Chiller)."

### WhisperCool™ Environmental Control System

Our patent-pending adaptive technology noticeably reduces operational noise, optimizes compressor and evaporator performance, decreases overall energy consumption, and prolongs compressor life. It is standard on select PolyScience Recirculating Chillers as well as  $-40^\circ\text{C}$  7 liter and all 15 liter and larger Refrigerated/Heated Circulating Baths.

### Working Access/Bath Opening

This dimension provides information on the amount of available space within the Circulator or Water Bath for glassware, sample holders, test tube racks, etc.

### Working Temperature Range

This is the temperature range over which the equipment can achieve and control without auxiliary heating or cooling at the stated temperature stability specification.

# Choosing a PolyScience Product

PolyScience produces a broad range of liquid temperature control equipment. In most cases, our products are not designed for a specific application but rather are engineered to provide stable heating or cooling over common operating temperature ranges. If your application requires maintaining a temperature near or below ambient temperature, then a refrigerated product such as a Recirculating Chiller or Circulating Bath is appropriate. The choice will depend on several factors. The following guidelines will help you determine the type of product, and model, best suited to your application:

1. Fluid operating temperature range and set-point
2. Cooling capacity (heat removal if set-point is near/below ambient)
3. Ambient temperature (affects cooling capacity)
4. Temperature stability (we offer choices from  $\pm 0.005^{\circ}\text{C}$  to  $\pm 0.1^{\circ}\text{C}$ )
5. External application (open or closed-loop determines pump type)
6. Reservoir size (if a bath is required)
7. Pump pressure and/or flow rate (if pumping to an external application)
8. External probe/programmability

Because air-cooled, refrigerated products rely on ambient air to remove heat from the refrigeration system, the ambient air temperature will affect a unit's cooling capacity. As a general practice when selecting a refrigerated product, decrease the product's cooling capacity rating 1.3% for every 1° that the ambient air temperature exceeds 20°C. For example, if the ambient temperature where the Circulator or Chiller is located is 22°C, then the cooling capacity of the product will be reduced by 2.6%. At set-points near ambient, heating products that lack refrigeration will have difficulty maintaining temperature and stability.

A typical Circulating Bath uses the ambient air to remove heat from the refrigeration system which, in turn, removes heat from the bath fluid.

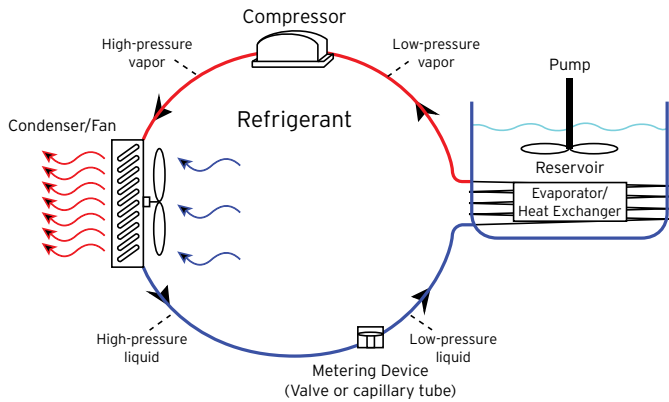

A typical air-cooled Chiller uses the ambient air to remove heat from the refrigeration system which, in turn, removes heat from the process fluid.

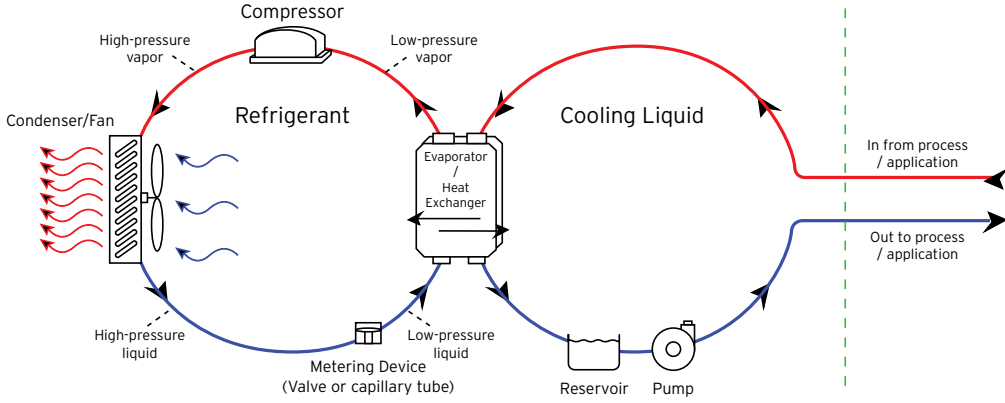



# Application Reference Guide

Understanding your application can assist us in providing you the right product for your needs. Below are some typical uses for PolyScience equipment.

## Refrigerated Circulators

Asphalt Sample Tempering  
Blood Thawing  
CCD Camera Cooling  
Cell Freezing  
Chromatography Column  
Cloud Point Testing  
Condenser Cooling  
Densitometer  
Distillation Apparatus  
Electrophoresis  
Freeze Point Determination  
Fourier Transform Infrared Spectroscopy (FTIR)  
General Lab Cooling  
Impact Testing  
Incubation  
Isoelectric Focusing  
Low Temperature Calibration  
Peltier Devices  
Photographic Solution Tempering  
Plasma Thawing  
Polarimeter  
Pour Point Testing  
Refractometers  
Rotary Evaporators  
Spectrophotometer  
Thermometry Calibration  
Turbo-molecular Pump  
Vacuum Systems and Traps  
Viscosity Measurement

## Immersion Probe and Flow-Through Coolers

Dry Ice Replacement  
Exothermic Reaction Cooling  
Impact Testing  
Liquid Nitrogen Replacement  
Lyophilization  
Quick Cooling  
Solvent Trapping  
Turbo-molecular Pump  
Vacuum System  
Vacuum Traps

## Calibration Baths

Low Temperature Calibration  
RTD Calibration  
Thermistor Calibration  
Thermometry Calibration

## Coliform Bath

Defined Substrate Technology Testing  
*E. coli* Determination  
Fecal Coliform Testing

## 75 L Circulating Bath

Beer Forced-Aging Tests  
Blood Thawing  
Food Stability Testing  
Product Quality Analysis

## Heated Circulators

Cell Culture  
Culture Media Warming  
DNA Melting Curves  
Enzyme Assays  
Incubation  
Kinetic Research  
Petroleum Testing  
Photographic Solution Tempering  
Plasma Thawing  
Polymer Studies  
Refractometer  
Sample Testing  
Temperature Gradients  
Thawing Frozen Samples  
Thermometry Calibration  
Viscosity Measurement  
Warming Culture Media

## MX Immersion Circulators

Bacterial Incubation  
Cell Culture  
Culture Media Warming  
Enzyme Assays  
Kinetic Research  
Sample Testing  
Sous Vide Cooking  
Thawing Frozen Samples  
Thermometry Calibration  
Viscosity Measurement  
Warming Culture Media

## General Purpose Water Baths

Plasma Thawing  
Thawing Frozen Samples  
Warming Culture Media

## Cyroprecipitate Bath

Whole Blood Thawing  
Fresh Frozen Plasma Thawing  
Thawing Frozen Samples

## Benchtop Chillers

CCD Camera Cooling  
Condenser Cooling  
Rotary Evaporators  
Laser Cooling

## Recirculating Coolers

Bioreactor  
CCD Camera Cooling  
Condenser Cooling  
Densitometer  
Electron Microscope  
Gas Chromatography-Mass Spectrometry (GC-MS)  
Inductively Coupled Plasma (ICP)  
Lasers  
Rotary Evaporators  
Spectrophotometer  
Welders

## 6000 & DuraChill™ Series Chillers

Acid Cooling  
Anodizing  
Atomic Absorption (AA) Furnace  
Bacterial Incubation  
Bakeries  
Bioreactor  
Blood Banks  
Blow Molding  
Chemical Processing  
Chromatography Column  
Computed Tomography (CT) Scanning  
Concentrator/Extractor  
Condenser Cooling  
Densitometer  
Diffusion Pump  
Distillation Apparatus  
Electrical Discharge Machining (EDM)  
Electron Microscope  
Fermentation  
Food Processing  
Gas Chromatography-Mass Spectrometry (GC-MS)  
Hydraulics Cooling  
Hydrocooling  
Impact Testing  
Inductively Coupled Plasma (ICP)  
Incubation Water Jacket  
Injection Molding  
Laboratories, General-Use Cooling  
Laminating  
Lasers  
Lithographic Equipment  
Machine Tool  
Milling Machines  
Magnetic Resonance Imaging (MRI)  
Medical Diagnostic Equipment  
Nuclear Magnetic Resonance (NMR)  
PET Scanners  
Pilot Plants  
Plasma Etching  
Plasma Torch Cutting  
Plastic Injection Molding  
Printing  
Reaction Vessel  
Refractometer  
Rotary Evaporators  
Scanning Electron Microscope  
Spectrophotometer  
Sputtering System  
Vacuum Forming  
Vacuum Systems and Traps  
Waterjet Cutting  
Welding  
Wine Fermentation  
X-ray Diffraction

# Selecting a Circulating Bath

The best PolyScience Circulating Bath for your application will depend on a number of factors. Here are some guidelines to help with your selection:

- 1. Working Temperature and Stability** - You will need a Refrigerated/Heated Circulator if your working temperature will ever be near or below ambient. Applications that require maximum temperatures above 160°C or  $\pm 0.01^\circ\text{C}$  temperature stability require Circulators with Performance or Advanced Series Temperature Controllers.
- 2. Cooling/Heating Demand** - A Circulator with a small reservoir is generally suitable if you require external circulation only and the heating/cooling demand is moderate. If the external heating/cooling demand is high or you will be putting samples in the internal reservoir, a Circulator with a larger reservoir will be required.
- 3. External Circulation** - All PolyScience Temperature Controllers can be used for close-loop external circulation. If open-loop external circulation is required or if your application requires a flow rate above 3 gpm (11 l/min), a Circulator with a Performance or Advanced Series Controller is required.

## Circulating Bath Heating and Cooling Performance

### Cooling Capacity

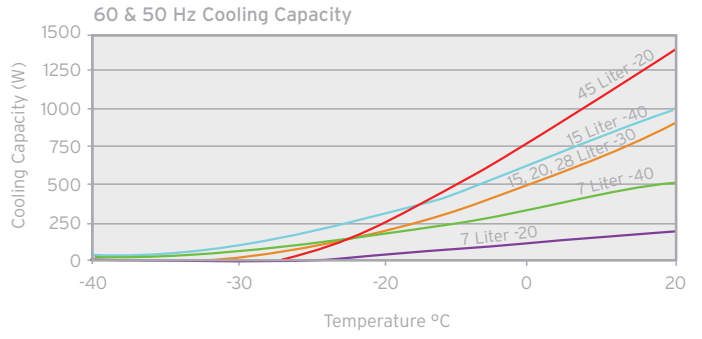

### Heating Rates

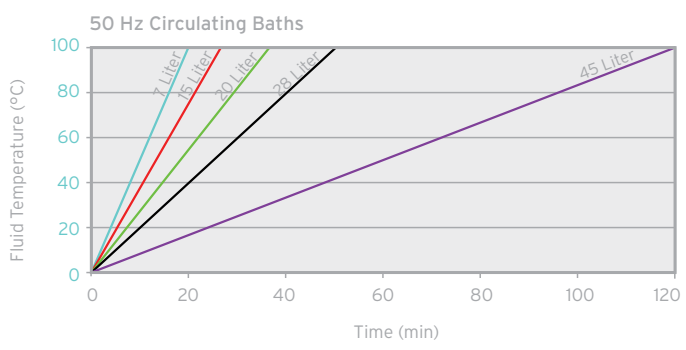
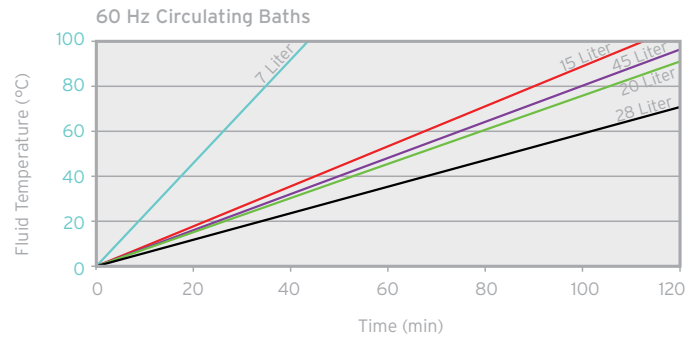

### Cooling Rates

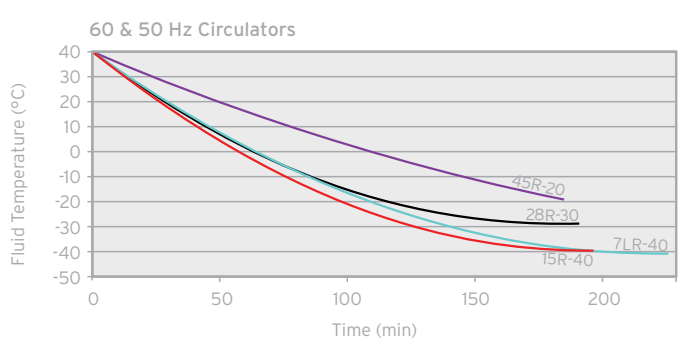
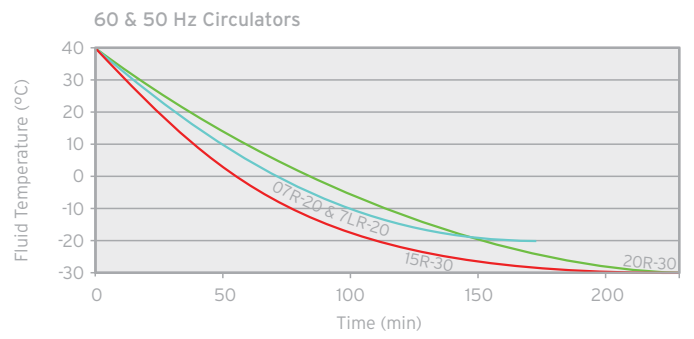

## A Quick Guide to Tubing and Fittings

PolyScience offers a variety of tubing and fittings for use when using your Circulator to control the temperature of an external bath or device. Here are some guidelines for selecting the best tubing and fittings for your application:

### Materials

**Buna N Tubing** – A synthetic (nitrile) rubber, Buna N is able to withstand temperatures from about -40° to +120°C and performs well with ethylene glycol, propylene glycol, mineral oil, and water.

**Viton® Tubing** – A synthetic rubber and fluoropolymer elastomer, Viton® has a broad operating temperature range (-32° to +200°C) and a chemical compatibility similar to Buna N.

**Braided Teflon® Tubing** – This high-strength tubing consists of an extruded Teflon® core with an outer stainless steel braid. It can handle extreme temperatures (-50° to +225°C) and pressures and also offers excellent chemical compatibility. Available in 1 m (39") lengths only, braided Teflon® tubing should be used in applications where the distance between the circulator and external device is relatively short. Each end has a male 1/4" pipe to 1/4" tube connector which can be quickly connected and disconnected.

**Stainless Steel Fittings** – Stainless steel fittings can handle extreme temperatures while also offering good chemical resistance. PolyScience Performance Series Temperature Controllers are shipped with stainless steel fittings.

**Nylon Fittings** – Their somewhat better chemical resistance to low temperature bath fluids than brass fittings make nylon fittings an excellent choice for applications where fluid does not exceed 90°C. Nylon fittings are standard equipment on PolyScience Advanced Programmable, Advanced Digital, and Standard Digital Temperature Controllers.

**Brass Fittings** – Strong and durable, brass fittings offer excellent corrosion resistance. They are best suited for low temperature applications (below 80°C).

### Tubing & Fitting Temperature Ranges

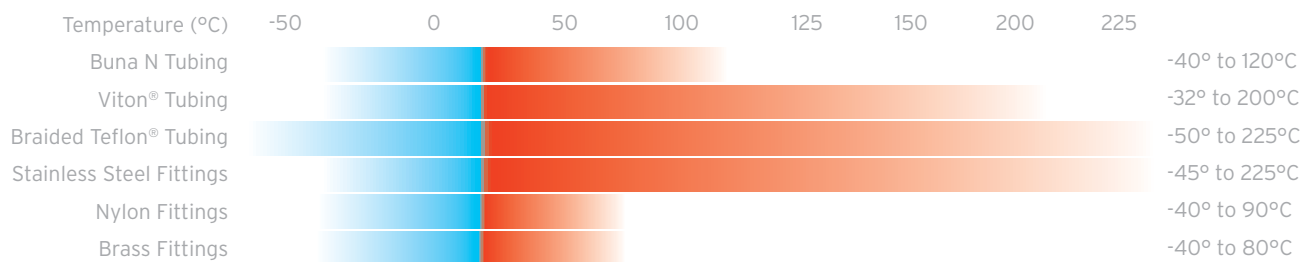

### Bypass Kits

PolyScience Circulating Baths are equipped with a Buna N bypass tubing kit that connects the Temperature Controller's inlet and outlet ports. It improves performance when external circulation is not needed. A Viton® bypass kit is available for high temperature (120°C and above) applications.

### Fluid Compatibility

Material of Construction	Buna N Tubing	Viton® Tubing	Braided Teflon® Tubing	Nylon Fitting	Brass Fittings	Stainless Steel Fittings
polycool EG -25 (ethylene glycol)	A	A	A	A	B	B
polycool PG -20 (propylene glycol)	A	A	A		B	B
polycool HC -50 (water-based heat transfer fluid)	B	B	A	B	B	B
polytherm S150 (silicone oil)	B	B	A		B	B
polytherm S200 (silicone oil)	B	B	A		B	B
polytherm S250 (silicone oil)	B	B	A		B	B
polytherm M170 (mineral oil)	A	A	A		B	A
polycool MIX -25 (glycol-based coolant)	A	A	A	A	B	B
polyclear MIX 30 (distilled water plus algaecide)	A	A	A	A	A	A

A = Excellent; B = Good

# How to Select a Chiller

Chillers provide heat removal for a wide variety of processes and equipment. When properly sized and selected, a chiller increases production speed and accuracy, protects valuable process equipment, and reduces water consumption and related costs. If it is undersized, the chiller will not cool properly; if it is oversized, it will be inefficient due to excessive cycling. In addition to having an adequate cooling capacity, the chiller must deliver the cooling fluid at the proper pressure and flow rate.

Here are the four basic factors that affect chiller sizing and selection:

- 1. Desired coolant temperature** - This is the coolant temperature at the inlet of your process or equipment. It is important to measure the temperature at this point to allow for coolant heating as it travels from the chiller to the process. The longer the distance to be covered, the higher the potential heat gain. This heat gain can be minimized by insulating the cooling line and positioning the chiller as close as practical to the equipment or process being cooled.
- 2. Heat load** - This is the amount of heat that needs to be removed. It is usually expressed in BTUs/hour or watts. The heat load value is often provided by the equipment manufacturer. If not, it can be calculated using the following formula:

$$\text{Heat load} = \text{Flow rate} \times \text{Fluid density} \times \text{Fluid specific heat} \times \text{Constant} \times \Delta T^\circ$$

	=	BTU/hour	Watts
Flow Rate	=	Gallons/minute	Liters/minute
Fluid Density	=	Pounds/gallon	Grams/liter
Fluid Specific Heat	=	BTU/pound °F	Joules/gram °C
Constant	=	60	0.016666667
$\Delta T^\circ$ = The difference between the inlet and outlet temperatures of the equipment being cooled	=	°F	°C

Fluid	Fluid Density		Specific Heat	
	Lbs/gallon	Grams/liter	BTU/lb°F	Joules/gram°C
Water @ 25°C (77°F)	8.333	1000	1	4.181
50% water, 50% propylene glycol @ 10°C (50°F)	8.744	1049.25	0.835	3.493
50% water, 50% ethylene glycol @ 10°C (50°F)	8.992	1078.72	0.776	3.245

- 3. Coolant flow and pressure** - These parameters are normally provided by the equipment manufacturer and are a function of the surface area and the heat transfer characteristics of the process/material being cooled. It is crucial that your chiller deliver coolant at the proper flow rate and pressure. If the flow rate or pressure is too high, the equipment being cooled may be damaged; if it is too low, the heat removal will be inadequate. PolyScience can help you specify the type and size of coolant pump most suitable for your needs.
- 4. Condenser heat dissipation** - The final factor influencing chiller/heat exchanger selection is how the heat removed will be dissipated. Chillers with air-cooled condensers exhaust heat into the surrounding air and require only power and ventilation for operation. Chillers with water-cooled condensers transfer heat to the facility's cooling water supply.

Naturally, there are other factors – such as heating capability, external temperature tracking, deionized water capability, etc. – that affect how a chiller is ultimately configured. PolyScience will take all of these into consideration when helping you select the best chiller for your particular application. Here is a summary of the information you'll need to know to ensure that the chiller you select is the best one for your application:

- Desired coolant temperature at the inlet to your equipment or process
- Anticipated heat load, as calculated or specified by the equipment manufacturer
- Cooling fluid flow rate and pressure requirements
- Maximum room (ambient) temperature where the chiller will be located
- Internal heat dissipation, space, and portability needs
- Special requirements, such as remote temperature tracking or piping for deionized water

It is generally recommended that 20% to 50% be added to the calculated heat load to provide a safety factor if the chiller will be operated at ambient temperatures above 20°C (68°F), at high altitude, or if the heat output of the device is variable. This will also provide a margin of safety for future cooling needs. That said, resist the temptation to build more of a safety margin into your chiller than is necessary; an oversized chiller will not cool your equipment any more effectively but will cost more to purchase and operate.

**Suggested Chiller Fluid.** The most common and acceptable coolant is a mixture of 50% distilled water and 50% ethylene glycol (polycool EG-25). This combination will provide the best results for set-point temperatures between -25°C and +80°C (-13°F and +176°F). Although ethylene glycol is not required for set-point temperatures above freezing (0°C/+32°F), it is highly recommended as glycol helps lubricate pump seals and fluid temperatures inside the chiller may be below freezing.

## Considerations For Pump Selection

**Turbine Pumps** - Provide moderate flow and moderate pressures<sup>1</sup> (90-100 psi, 6.2-6.9 bar) which makes them well suited to applications that require higher pressure or experience a higher system pressure drop, such as long tubing runs or pumping vertically. A robust design makes turbine pumps very reliable and forgiving to impurities in the fluid stream. Bronze turbine pumps are standard, stainless steel pumps are available.

**Positive Displacement Pumps** - Have performance characteristics similar to turbine pumps and are suitable for high viscosity fluids, or pumping higher or further from the cooling product and the application. They produce moderate flow at high pressure<sup>1</sup>; up to 100 psi (6.9 bar). Brass positive displacement pumps are standard, stainless steel positive displacement pumps are available.

**Centrifugal Pumps (Magnetic Drive)** - Offer higher relative flow rates at lower pressures and are suitable for applications that are in close proximity to the chiller or require lower pressure, such as glass condensers. Centrifugal pumps are very quiet and require little maintenance, but they are more sensitive to pressure drops. Chillers with this pump option that are attached to a device with a solenoid valve coolant shut-off, require the external bypass accessory.

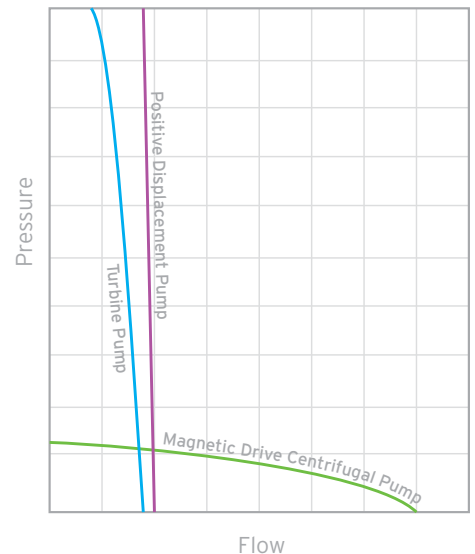

<sup>1</sup>Recirculating Chillers and Heat Exchangers equipped with turbine or positive displacement pumps are supplied with an adjustable pressure regulator to allow output pressure to be set from 20 psi (1.37 bar) to 100 psi (6.90 bar).

# Chiller Cooling Curves

## Benchtop Series Chillers

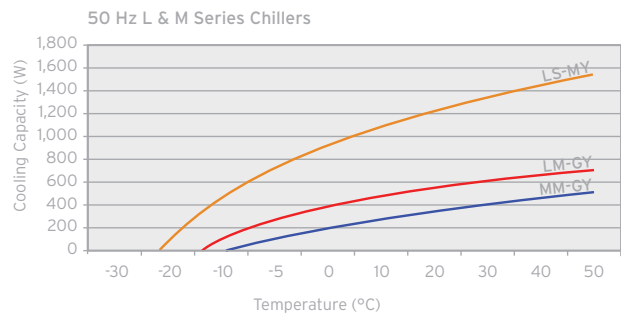
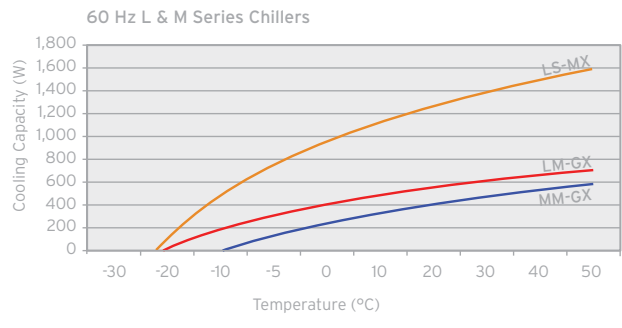

## 6000 Series Chillers

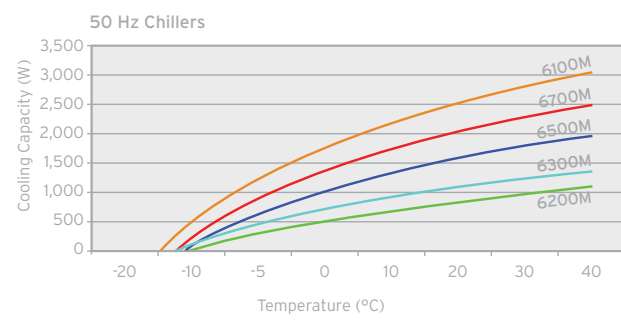
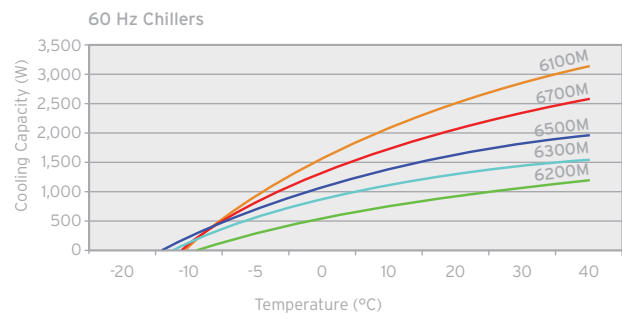

## DuraChill™ Portable Chillers

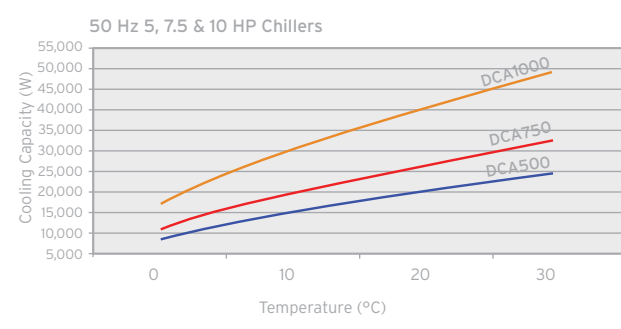
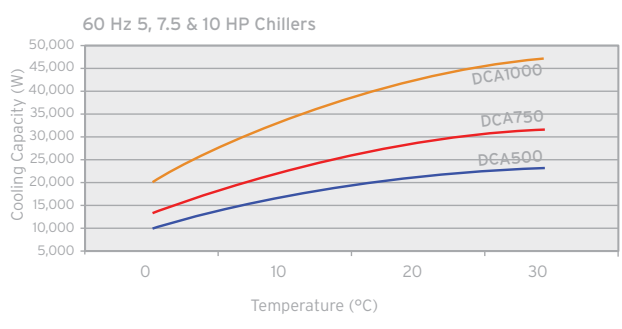
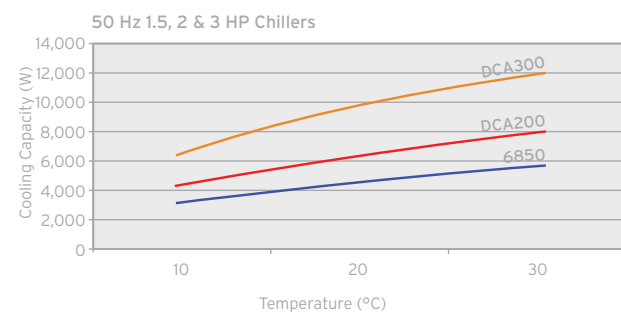
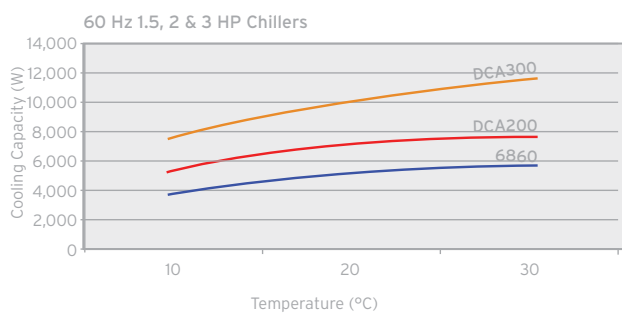

Cooling capacity curves are representative of the model shown and may vary depending on pump type, heat load, and ambient conditions.

# DuraChill™ Factory Installed Options

The following list provides a brief description of the options available on DuraChill™ chillers. Please contact our Sales and Customer Service Departments for assistance in selecting the best options for your application. See Factory Installed Chiller Options, page 109.

**Alarm Output (Dry Contact)** - A dry contact relay that can be used to activate an external alarm when an alarm or fault condition is detected.

**Audible & Visual Alarms** - Local audible and visual signals to alert the operator to alarm or fault conditions.

**Conductivity Control** - Controls the conductivity of the coolant at a preset level. Includes conductivity controller, filter, and flow meter with valve. For use with DI water package, below.

**Deionized Water Package** - All wetted components compatible for use with deionized water.

**External Temperature Tracking** - Allows set-point control based on room, machinery or material temperature. External temperature probe required (see Chiller Accessories, pages 111-112).

**External Water Filter** - Filters particulates and other contaminants from process lines. May be installed on either the Chiller inlet or outlet.

**Full Flow Bypass Valve** - Automatically diverts flow to protect the pump in the event of a blockage in the process or process line.

**Heater** - Extends the upper operating temperature of the Chiller and provides the ability to apply heat above the cooling temperature range. This option is useful when cooling devices that must be brought to a temperature above ambient before operation can begin.

**High Ambient Temperature Package** - Permits Chiller operation at ambient temperatures up to +40°C/+104°F.

**High/Low Pressure Cutout Switches** - Automatically disconnects power to the refrigeration system in the event refrigerant pressure is outside the factory-set values.

**Higher Output Centrifugal Pump** - For high flow/low pressure applications; 0.10 to 3.0 HP stainless steel pumps available.

**Higher Output Positive Displacement Pump** - For low flow/high pressure applications; 2.33 to 3.5 gpm (8.8 to 13.2 l/min) pumps available.

**Higher Output Turbine Pump** - For high flow/high pressure applications; 0.75 and 1.0 HP stainless steel pumps and 0.75 to 5.0 HP bronze pumps available.

**Low Ambient Temperature Package** - Permits Chiller operation at ambient temperatures as low as -28.8°C/-20°F.

**Low Liquid Level Switch Alarm** - Alerts the operator when the fluid level in the reservoir drops too low.

**No Reservoir** - For applications where cooling fluid is contained in an external reservoir.

**Non-standard Process Temperatures** - -9° to +30°C/+15° to +86°F.

**Remote On/Off (24 VDC)** - Allows operator to turn Chiller power on/off via a 24VDC signal from a control room or other remote location.

**Remote On/Off (Dry Contact)** - Allows operator to turn Chiller power on/off via a contact closure from a control room or other remote location.

**RS232/RS485 Communication** - Allows the operator to remotely control the Chiller and/or output temperature readings to an external recorder or other auxiliary device.

**Stainless Steel Reservoir** - For applications with higher process temperatures.

**Tank Sight Glass or Level Indicator** - Serves as a convenient means of checking the fluid level within the reservoir.

**Water Cooled Condenser** - For applications where facility water will be used to cool the Chiller condenser.

# Product Part Numbers and Electrical Plug Options











Most PolyScience part numbers are constructed from the attributes of a product. Each section of the part number has a specific meaning. Example: for part number PP07R-20-A11B,

PP07R-20 represents the model, and:

- PP = Controller Model (Performance Programmable)
- 07 = Reservoir Capacity (7 Liters)
- R = Heating or Refrigerated (Refrigerated Bath)
- 20 = Upper or Lower Temperature Capability (-20°C), depending on model
- A1 = Finish (PolyScience Silver)
  - 1 = Voltage/Frequency (1 = 120 Volts/60 Hertz)
  - B = Electrical Plug Type (B=US-Type, 120 Volts, 13 Amp)

The last character, B, represents the type of electrical plug that will ship with your product. Electrical plugs for the part numbers listed throughout the catalog are for standard U.S. and European types. To accommodate our customers throughout the world, PolyScience provides optional electrical plugs at no additional cost when ordered with the product.

To choose the correct plug for your product, please select from the table below and substitute the appropriate **Plug Designation** for the last character of the part number for the product you have selected. If you are uncertain of which plug type you need, please contact PolyScience for assistance.

Country	PolyScience Plug Designation	
USA (120 VAC)	B or C	
European, standard (240 VAC)	E	
USA (230 VAC)	D	
Argentina, Australia, New Zealand	A	
United Kingdom, Bangladesh, China, Hong Kong, Ireland, Malaysia, Nigeria, Saudi Arabia, Singapore, UAE, Vietnam, Zambia, Zimbabwe	P	
China (similar to A but polarity is reversed)	Y	
Argentina (similar to A but with different pin lengths)	G	
Korea	K	
India, Pakistan, South Africa	M	
Israel	R	
Chile, Italy, Syria	S	
Denmark, Bangladesh	T	
Switzerland	Z	



# Getting the Most from Your PolyScience Circulating Bath or Chiller

While PolyScience Circulators and Chillers are designed to deliver exceptional temperature control and stability in many different applications and environments, there are some simple ways to further ensure optimal performance.

To Improve			Do This
Temperature Stability	Cooling Capacity	Heating Capacity	
•	•	•	Use the fluid most appropriate for the required temperature range
•	•	•	Operate the Circulator with the reservoir cover in place
	•		Use the Circulator's lowest pump speed (this also enhances uniformity since higher pump speeds add more heat to the bath)
•			Operate the Circulator with the bypass tubing (supplied) connected to the inlet and outlet ports
	•	•	<u>When circulating externally:</u> - Use larger diameter fittings and tubing - Use the shortest possible tubing lengths - Insulate all tubing
•	•		Locate the unit out of direct sunlight, away from heat sources, and ideally, in an environment with the lowest possible ambient temperature
	•		Keep the rear and side vents on Refrigerated Circulators and Chillers clear
	•		Keep the air filter on Refrigerated Circulators and Chillers clean

## Regulatory Testing and Compliance

To help ensure the utmost product safety, performance, and reliability, PolyScience temperature control equipment complies with variety of international standards, such as those listed below. Product conformance with a specific standard is dependent on the type of product, electrical configuration, and other factors.

### Compliance Marks

**CE** – The CE mark certifies that a product complies with European Union consumer safety, health, or environmental requirements.

**ETL** – The ETL mark certifies that a product complies with North American electrical and safety standards, including those written by Underwriters Laboratories (UL) and the Canadian Standards Association (CSA).

**CSA** – The CSA mark certifies that a product has been tested and meets applicable North American standards for safety and/or performance, including those of the Canadian Standards Association (CSA) and Underwriters Laboratories (UL).

### Testing Standards

**IEC** – This is the International Electrotechnical Commission. It is the international standards and conformity assessment body for electrical, electronic, and related technologies.

**IEC 61010-1** – The IEC standard specifying the general safety requirements for electrical equipment for measurement, control, and laboratory use.

**IEC 61010-2-010** – Part of IEC 61010, this standard applies to electrically powered laboratory equipment for the heating of materials.

**IEC 61326-1** – This IEC standard specifies requirements for immunity and emissions regarding electromagnetic compatibility (EMC) for electrical equipment.

**DIN 12876** – A standard issued by the German Institute for Standardization that classifies, describes, and sets safety and warning requirements for electrical laboratory equipment.

**CSA C22.2 No. 120-M91** – A standard issued by the Canadian Standards Association (CSA) regarding the safety of refrigerating equipment.

**UL 427** – A standard issued by Underwriters Laboratories (UL) regarding the safety of refrigerating equipment.

**UL 873** – A standard issued by Underwriters Laboratories (UL) regarding the safety requirements for temperature indicating and temperature regulating equipment.

**UL 508C** – A standard issued by Underwriters Laboratories (UL) regarding the safety requirements for power conversion equipment.

### Environmental Standards

**RoHS** – This is the Restriction of Hazardous Substances Directive adopted by the European Union. It restricts the use of lead (Pb), mercury (Hg), cadmium (Cd), hexavalent chromium (Cr6+), polybrominated biphenyls (PBB), and polybrominated diphenyl ether (PBDE) in the manufacture of various types of electronic and electrical equipment.

**WEEE** – This is the Waste Electrical and Electronic Equipment Directive adopted by the European Union. It imposes responsibilities regarding the collection, recycling, and recovery for electrical equipment.

# Technical Specifications

## Refrigerated Circulating Baths, 60 Hz Models

Model	Description	Catalog Page Number	Controller Type	Temperature Range		Temperature Stability		Display Resolution		Reservoir Capacity gal/ltr	Cooling Capacity @ (W)				Heater Wattage	Display/Interface	Pump Type
				°F	°C	°F	°C	Set	Read		100°C	20°C	0°C	-20°C			
				PP07R-20	-20, 7 L Ref. Circulator	34-35	Performance Programmable	-4° to 392°	-20° to 200°		±0.01°	±0.005°	0.01	0.001			
PP07R-40	-40, 7 L Ref. Circulator	34-35	Performance Programmable	-40° to 392°	-40° to 200°	±0.01°	±0.005°	0.01	0.001	1.85/7.0	505	505	375	130	1100	4.3" SmartTouch Touchscreen	Pressure/Suction
PP7LR-20	-20, 7 L Ref. Circulator	34-35	Performance Programmable	-4° to 392°	-20° to 200°	±0.01°	±0.005°	0.01	0.001	1.85/7.0	200	200	120	30	1100	4.3" SmartTouch Touchscreen	Pressure/Suction
PP15R-30	-30, 15 L Ref. Circulator	34-35	Performance Programmable	-22° to 392°	-30° to 200°	±0.01°	±0.005°	0.01	0.001	3.96/15.0	915	915	505	165	1100	4.3" SmartTouch Touchscreen	Pressure/Suction
PP15R-40	-40, 15 L Ref. Circulator	34-35	Performance Programmable	-40° to 392°	-40° to 200°	±0.01°	±0.005°	0.01	0.001	3.96/15.0	1,000	1,000	650	265	1100	4.3" SmartTouch Touchscreen	Pressure/Suction
PP20R-30	-30, 20 L Ref. Circulator	34-35	Performance Programmable	-22° to 392°	-30° to 200°	±0.01°	±0.005°	0.01	0.001	5.28/20.0	915	915	505	165	1100	4.3" SmartTouch Touchscreen	Pressure/Suction
PP28R-30	-30, 28 L Ref. Circulator	34-35	Performance Programmable	-22° to 392°	-30° to 200°	±0.01°	±0.005°	0.01	0.001	7.4/28.0	915	915	505	165	1100	4.3" SmartTouch Touchscreen	Pressure/Suction
PP45R-20	-20, 45 L Ref. Circulator	34-35	Performance Programmable	-13° to 275°	-25° to 135°	±0.01°	±0.005°	0.01	0.001	11.88/45.0	1,400	1,400	800	250	2200	4.3" SmartTouch Touchscreen	Pressure/Suction
AP07R-20	-20, 7 L Ref. Circulator	36-37	Advanced Programmable	-4° to 392°	-20° to 200°	±0.02°	±0.01°	0.01	0.001	1.85/7.0	200	200	120	30	1100	4.3" SmartTouch Touchscreen	Pressure/Suction
AP07R-40	-40, 7 L Ref. Circulator	36-37	Advanced Programmable	-40° to 392°	-40° to 200°	±0.02°	±0.01°	0.01	0.001	1.85/7.0	505	505	375	130	1100	4.3" SmartTouch Touchscreen	Pressure/Suction
AP7LR-20	-20, 7 L Ref. Circulator	36-37	Advanced Programmable	-4° to 392°	-20° to 200°	±0.02°	±0.01°	0.01	0.001	1.85/7.0	200	200	120	30	1100	4.3" SmartTouch Touchscreen	Pressure/Suction
AP15R-30	-30, 15 L Ref. Circulator	36-37	Advanced Programmable	-22° to 392°	-30° to 200°	±0.02°	±0.01°	0.01	0.001	3.96/15.0	915	915	505	165	1100	4.3" SmartTouch Touchscreen	Pressure/Suction
AP15R-40	-40, 15 L Ref. Circulator	36-37	Advanced Programmable	-40° to 392°	-40° to 200°	±0.02°	±0.01°	0.01	0.001	3.96/15.0	1,000	1,000	650	265	1100	4.3" SmartTouch Touchscreen	Pressure/Suction
AP20R-30	-30, 20 L Ref. Circulator	36-37	Advanced Programmable	-22° to 392°	-30° to 200°	±0.02°	±0.01°	0.01	0.001	5.28/20.0	915	915	505	165	1100	4.3" SmartTouch Touchscreen	Pressure/Suction
AP28R-30	-30, 28 L Ref. Circulator	36-37	Advanced Programmable	-22° to 392°	-30° to 200°	±0.02°	±0.01°	0.01	0.001	7.4/28.0	915	915	505	165	1100	4.3" SmartTouch Touchscreen	Pressure/Suction
AP45R-20	-20, 45 L Ref. Circulator	36-37	Advanced Programmable	-13° to 275°	-25° to 135°	±0.02°	±0.01°	0.01	0.001	11.88/45.0	1,400	1,400	800	250	2200	4.3" SmartTouch Touchscreen	Pressure/Suction
PD07R-20	-20, 7 L Ref. Circulator	38-39	Performance Digital	-4° to 392°	-20° to 200°	±0.01°	±0.005°	0.01	0.001	1.85/7.0	200	200	120	30	1100	4.3" SmartTouch Touchscreen	Pressure/Suction
PD07R-40	-40, 7 L Ref. Circulator	38-39	Performance Digital	-40° to 392°	-40° to 200°	±0.01°	±0.005°	0.01	0.001	1.85/7.0	505	505	375	130	1100	4.3" SmartTouch Touchscreen	Pressure/Suction
PD7LR-20	-20, 7 L Ref. Circulator	38-39	Performance Digital	-4° to 392°	-20° to 200°	±0.01°	±0.005°	0.01	0.001	1.85/7.0	200	200	120	30	1100	4.3" SmartTouch Touchscreen	Pressure/Suction
PD15R-30	-30, 15 L Ref. Circulator	38-39	Performance Digital	-22° to 392°	-30° to 200°	±0.01°	±0.005°	0.01	0.001	3.96/15.0	915	915	505	165	1100	4.3" SmartTouch Touchscreen	Pressure/Suction
PD15R-40	-40, 15 L Ref. Circulator	38-39	Performance Digital	-40° to 392°	-40° to 200°	±0.01°	±0.005°	0.01	0.001	3.96/15.0	1,000	1,000	650	265	1100	4.3" SmartTouch Touchscreen	Pressure/Suction
PD20R-30	-30, 20 L Ref. Circulator	38-39	Performance Digital	-22° to 392°	-30° to 200°	±0.01°	±0.005°	0.01	0.001	5.28/20.0	915	915	505	165	1100	4.3" SmartTouch Touchscreen	Pressure/Suction
PD28R-30	-30, 28 L Ref. Circulator	38-39	Performance Digital	-22° to 392°	-30° to 200°	±0.01°	±0.005°	0.01	0.001	7.4/28.0	915	915	505	165	1100	4.3" SmartTouch Touchscreen	Pressure/Suction
PD45R-20	-20, 45 L Ref. Circulator	38-39	Performance Digital	-13° to 275°	-25° to 135°	±0.01°	±0.005°	0.01	0.001	11.88/45.0	1,400	1,400	800	250	2200	4.3" SmartTouch Touchscreen	Pressure/Suction
AD07R-20	-20, 7 L Ref. Circulator	40-41	Advanced Digital	-4° to 392°	-20° to 200°	±0.02°	±0.01°	0.01	0.01	1.85/7.0	200	200	120	30	1100	3.75" Touch-Pad LCD	Pressure/Suction
AD07R-40	-40, 7 L Ref. Circulator	40-41	Advanced Digital	-40° to 392°	-40° to 200°	±0.02°	±0.01°	0.01	0.01	1.85/7.0	505	505	375	130	1100	3.75" Touch-Pad LCD	Pressure/Suction
AD7LR-20	-20, 7 L Ref. Circulator	40-41	Advanced Digital	-4° to 392°	-20° to 200°	±0.02°	±0.01°	0.01	0.01	1.85/7.0	200	200	120	30	1100	3.75" Touch-Pad LCD	Pressure/Suction
AD15R-30	-30, 15 L Ref. Circulator	40-41	Advanced Digital	-22° to 392°	-30° to 200°	±0.02°	±0.01°	0.01	0.01	3.96/15.0	915	915	505	165	1100	3.75" Touch-Pad LCD	Pressure/Suction
AD15R-40	-40, 15 L Ref. Circulator	40-41	Advanced Digital	-40° to 392°	-40° to 200°	±0.02°	±0.01°	0.01	0.01	3.96/15.0	1,000	1,000	650	265	1100	3.75" Touch-Pad LCD	Pressure/Suction
AD20R-30	-30, 20 L Ref. Circulator	40-41	Advanced Digital	-22° to 392°	-30° to 200°	±0.02°	±0.01°	0.01	0.01	5.28/20.0	915	915	505	165	1100	3.75" Touch-Pad LCD	Pressure/Suction
AD28R-30	-30, 28 L Ref. Circulator	40-41	Advanced Digital	-22° to 392°	-30° to 200°	±0.02°	±0.01°	0.01	0.01	7.4/28.0	915	915	505	165	1100	3.75" Touch-Pad LCD	Pressure/Suction
AD45R-20	-20, 45 L Ref. Circulator	40-41	Advanced Digital	-13° to 275°	-25° to 135°	±0.02°	±0.01°	0.01	0.01	11.88/45.0	1,400	1,400	800	250	2200	3.75" Touch-Pad LCD	Pressure/Suction
SD07R-20	-20, 7 L Ref. Circulator	42-43	Standard Digital	-4° to 338°	-20° to 170°	±0.08°	±0.04°	0.1	0.1	1.85/7.0	200	200	120	30	1100	3.75" Touch-Pad LCD	Pressure
SD7LR-20	-20, 7 L Ref. Circulator	42-43	Standard Digital	-4° to 338°	-20° to 170°	±0.08°	±0.04°	0.1	0.1	1.85/7.0	200	200	120	30	1100	3.75" Touch-Pad LCD	Pressure
SD15R-30	-30, 15 L Ref. Circulator	42-43	Standard Digital	-22° to 338°	-30° to 170°	±0.08°	±0.04°	0.1	0.1	3.96/15.0	915	915	505	165	1100	3.75" Touch-Pad LCD	Pressure

Pump Speeds	Maximum Pressure		Maximum Pressure Flow Rate		Maximum Suction Flow Rate		Process Connections	Working Access	Overall Dimensions		Flammability Class	Over-Temperature Protection/ Failsafe Heater Control	Low Level Protection	Reservoir Drain	Maximum Ambient Temperature		Refrigerant	Electrical Requirements		Shipping Weight		Model		
	psi	bar	gpm	l/min	gpm	l/min			L x W x D						L x W x H			DIN 12876-1	°F	°C	VAC/Hz/Ph/A		lb	kg
Variable	4.3	0.30	5.3	20.1	3.9	14.7	1/4" (F) NPT	6.18 x 5.59 x 5" 15.7 x 14.2 x 12.7 cm	21.3 x 8.7 x 24.3" 54.1 x 22.1 x 61.7 cm	III (FL)	•	•	•	95°	35°	R134a	120/60/1/12	90	40.8	PP07R-20				
Variable	4.3	0.30	5.3	20.1	3.9	14.7	1/4" (F) NPT	6.18 x 5.59 x 5" 15.7 x 14.2 x 12.7 cm	21.3 x 8.7 x 24.3" 54.1 x 22.1 x 61.7 cm	III (FL)	•	•	•	95°	35°	R404A	120/60/1/12	90	40.8	PP07R-40				
Variable	4.3	0.30	5.3	20.1	3.9	14.7	1/4" (F) NPT	6.18 x 5.59 x 5" 15.7 x 14.2 x 12.7 cm	23.2 x 16.2 x 16.2" 58.9 x 41.1 x 41.1 cm	III (FL)	•	•	•	95°	35°	R134a	120/60/1/12	90	40.8	PP7LR-20				
Variable	4.3	0.30	5.3	20.1	3.9	14.7	1/4" (F) NPT	8.35 x 10.88 x 5.5" 21.2 x 27.6 x 14 cm	22.4 x 14.5 x 26.9" 56.9 x 36.8 x 68.3 cm	III (FL)	•	•	•	95°	35°	R134a	120/60/1/13	118	53.5	PP15R-30				
Variable	4.3	0.30	5.3	20.1	3.9	14.7	1/4" (F) NPT	8.35 x 10.88 x 5.5" 21.2 x 27.6 x 14 cm	22.4 x 14.5 x 26.9" 56.9 x 36.8 x 68.3 cm	III (FL)	•	•	•	95°	35°	R404A	120/60/1/13	118	53.5	PP15R-40				
Variable	4.3	0.30	5.3	20.1	3.9	14.7	1/4" (F) NPT	9.85 x 12.45 x 5.5" 25 x 31.6 x 14 cm	24 x 16.6 x 26.9" 61 x 41.9 x 68.3 cm	III (FL)	•	•	•	95°	35°	R134a	120/60/1/13	130	58.9	PP20R-30				
Variable	4.3	0.30	5.3	20.1	3.9	14.7	1/4" (F) NPT	12.35 x 14.13 x 5.5" 31.4 x 35.9 x 14 cm	26.5 x 18 x 26.9" 67.2 x 45.7 x 68.3 cm	III (FL)	•	•	•	95°	35°	R134a	120/60/1/13	146	66.1	PP28R-30				
Variable	4.3	0.30	5.3	20.1	3.9	14.7	1/4" (F) NPT	21.6 x 15.68 x 5.5" 54.9 x 39.8 x 14 cm	35.8 x 22.4 x 42.1" 90.9 x 56.8 x 107 cm	III (FL)	•	•	•	95°	35°	R134a	208-240/50-60/1/13	180	81.5	PP45R-20				
Variable	4.3	0.30	5.3	20.1	3.9	14.7	1/4" (F) NPT	6.18 x 5.59 x 5" 15.7 x 14.2 x 12.7 cm	21.3 x 8.7 x 24.3" 54.1 x 22.1 x 61.7 cm	III (FL)	•	•	•	95°	35°	R134a	120/60/1/12	90	40.8	AP07R-20				
Variable	4.3	0.30	5.3	20.1	3.9	14.7	1/4" (F) NPT	6.18 x 5.59 x 5" 15.7 x 14.2 x 12.7 cm	21.3 x 8.7 x 24.3" 54.1 x 22.1 x 61.7 cm	III (FL)	•	•	•	95°	35°	R404A	120/60/1/12	90	40.8	AP07R-40				
Variable	4.3	0.30	5.3	20.1	3.9	14.7	1/4" (F) NPT	6.18 x 5.59 x 5" 15.7 x 14.2 x 12.7 cm	23.2 x 16.2 x 16.2" 58.9 x 41.1 x 41.1 cm	III (FL)	•	•	•	95°	35°	R134a	120/60/1/12	90	40.8	AP7LR-20				
Variable	4.3	0.30	5.3	20.1	3.9	14.7	1/4" (F) NPT	8.35 x 10.88 x 5.5" 21.2 x 27.6 x 14 cm	22.4 x 14.5 x 26.9" 56.9 x 36.8 x 68.3 cm	III (FL)	•	•	•	95°	35°	R134a	120/60/1/13	118	53.5	AP15R-30				
Variable	4.3	0.30	5.3	20.1	3.9	14.7	1/4" (F) NPT	8.35 x 10.88 x 5.5" 21.2 x 27.6 x 14 cm	22.4 x 14.5 x 26.9" 56.9 x 36.8 x 68.3 cm	III (FL)	•	•	•	95°	35°	R404A	120/60/1/13	118	53.5	AP15R-40				
Variable	4.3	0.30	5.3	20.1	3.9	14.7	1/4" (F) NPT	9.85 x 12.45 x 5.5" 25 x 31.6 x 14 cm	24 x 16.6 x 26.9" 61 x 41.9 x 68.3 cm	III (FL)	•	•	•	95°	35°	R134a	120/60/1/13	130	58.9	AP20R-30				
Variable	4.3	0.30	5.3	20.1	3.9	14.7	1/4" (F) NPT	12.35 x 14.13 x 5.5" 31.4 x 35.9 x 14 cm	26.5 x 18 x 26.9" 67.2 x 45.7 x 68.3 cm	III (FL)	•	•	•	95°	35°	R134a	120/60/1/13	146	66.1	AP28R-30				
Variable	4.3	0.30	5.3	20.1	3.9	14.7	1/4" (F) NPT	21.6 x 15.68 x 5.5" 54.9 x 39.8 x 14 cm	35.8 x 22.4 x 42.1" 90.9 x 56.8 x 107 cm	III (FL)	•	•	•	95°	35°	R134a	208-240/50-60/1/13	180	81.5	AP45R-20				
Variable	4.3	0.30	5.3	20.1	3.9	14.7	1/4" (F) NPT	6.18 x 5.59 x 5" 15.7 x 14.2 x 12.7 cm	21.3 x 8.7 x 24.3" 54.1 x 22.1 x 61.7 cm	III (FL)	•	•	•	95°	35°	R134a	120/60/1/12	90	40.8	PD07R-20				
Variable	4.3	0.30	5.3	20.1	3.9	14.7	1/4" (F) NPT	6.18 x 5.59 x 5" 15.7 x 14.2 x 12.7 cm	21.3 x 8.7 x 24.3" 54.1 x 22.1 x 61.7 cm	III (FL)	•	•	•	95°	35°	R404A	120/60/1/12	90	40.8	PD07R-40				
Variable	4.3	0.30	5.3	20.1	3.9	14.7	1/4" (F) NPT	6.18 x 5.59 x 5" 15.7 x 14.2 x 12.7 cm	23.2 x 16.2 x 16.2" 58.9 x 41.1 x 41.1 cm	III (FL)	•	•	•	95°	35°	R134a	120/60/1/12	90	40.8	PD7LR-20				
Variable	4.3	0.30	5.3	20.1	3.9	14.7	1/4" (F) NPT	8.35 x 10.88 x 5.5" 21.2 x 27.6 x 14 cm	22.4 x 14.5 x 26.9" 56.9 x 36.8 x 68.3 cm	III (FL)	•	•	•	95°	35°	R134a	120/60/1/13	118	53.5	PD15R-30				
Variable	4.3	0.30	5.3	20.1	3.9	14.7	1/4" (F) NPT	8.35 x 10.88 x 5.5" 21.2 x 27.6 x 14 cm	22.4 x 14.5 x 26.9" 56.9 x 36.8 x 68.3 cm	III (FL)	•	•	•	95°	35°	R404A	120/60/1/13	118	53.5	PD15R-40				
Variable	4.3	0.30	5.3	20.1	3.9	14.7	1/4" (F) NPT	9.85 x 12.45 x 5.5" 25 x 31.6 x 14 cm	24 x 16.6 x 26.9" 61 x 41.9 x 68.3 cm	III (FL)	•	•	•	95°	35°	R134a	120/60/1/13	130	58.9	PD20R-30				
Variable	4.3	0.30	5.3	20.1	3.9	14.7	1/4" (F) NPT	12.35 x 14.13 x 5.5" 31.4 x 35.9 x 14 cm	26.5 x 18 x 26.9" 67.2 x 45.7 x 68.3 cm	III (FL)	•	•	•	95°	35°	R134a	120/60/1/13	146	66.1	PD28R-30				
Variable	4.3	0.30	5.3	20.1	3.9	14.7	1/4" (F) NPT	21.6 x 15.68 x 5.5" 54.9 x 39.8 x 14 cm	35.8 x 22.4 x 42.1" 90.9 x 56.8 x 107 cm	III (FL)	•	•	•	95°	35°	R134a	208-240/50-60/1/13	180	81.5	PD45R-20				
Variable	4.3	0.30	5.3	20.1	3.9	14.7	1/4" (F) NPT	6.18 x 5.59 x 5" 15.7 x 14.2 x 12.7 cm	21.3 x 8.7 x 24.3" 54.1 x 22.1 x 61.7 cm	III (FL)	•	•	•	95°	35°	R134a	120/60/1/12	90	40.8	AD07R-20				
Variable	4.3	0.30	5.3	20.1	3.9	14.7	1/4" (F) NPT	6.18 x 5.59 x 5" 15.7 x 14.2 x 12.7 cm	21.3 x 8.7 x 24.3" 54.1 x 22.1 x 61.7 cm	III (FL)	•	•	•	95°	35°	R404A	120/60/1/12	90	40.8	AD07R-40				
Variable	4.3	0.30	5.3	20.1	3.9	14.7	1/4" (F) NPT	6.18 x 5.59 x 5" 15.7 x 14.2 x 12.7 cm	23.2 x 16.2 x 16.2" 58.9 x 41.1 x 41.1 cm	III (FL)	•	•	•	95°	35°	R134a	120/60/1/12	90	40.8	AD7LR-20				
Variable	4.3	0.30	5.3	20.1	3.9	14.7	1/4" (F) NPT	8.35 x 10.88 x 5.5" 21.2 x 27.6 x 14 cm	22.4 x 14.5 x 26.9" 56.9 x 36.8 x 68.3 cm	III (FL)	•	•	•	95°	35°	R134a	120/60/1/13	118	53.5	AD15R-30				
Variable	4.3	0.30	5.3	20.1	3.9	14.7	1/4" (F) NPT	8.35 x 10.88 x 5.5" 21.2 x 27.6 x 14 cm	22.4 x 14.5 x 26.9" 56.9 x 36.8 x 68.3 cm	III (FL)	•	•	•	95°	35°	R404A	120/60/1/13	118	53.5	AD15R-40				
Variable	4.3	0.30	5.3	20.1	3.9	14.7	1/4" (F) NPT	9.85 x 12.45 x 5.5" 25 x 31.6 x 14 cm	24 x 16.6 x 26.9" 61 x 41.9 x 68.3 cm	III (FL)	•	•	•	95°	35°	R134a	120/60/1/13	130	58.9	AD20R-30				
Variable	4.3	0.30	5.3	20.1	3.9	14.7	1/4" (F) NPT	12.35 x 14.13 x 5.5" 31.4 x 35.9 x 14 cm	26.5 x 18 x 26.9" 67.2 x 45.7 x 68.3 cm	III (FL)	•	•	•	95°	35°	R134a	120/60/1/13	146	66.1	AD28R-30				
Variable	4.3	0.30	5.3	20.1	3.9	14.7	1/4" (F) NPT	21.6 x 15.68 x 5.5" 54.9 x 39.8 x 14 cm	35.8 x 22.4 x 42.1" 90.9 x 56.8 x 107 cm	III (FL)	•	•	•	95°	35°	R134a	208-240/50-60/1/13	180	81.5	AD45R-20				
Two	3.5	0.24	2.9	11.0			1/4" (F) NPT	6.18 x 5.59 x 5" 15.7 x 14.2 x 12.7 cm	21.3 x 8.7 x 24.3" 54.1 x 22.1 x 61.7 cm	I (NFL)	•	•	•	95°	35°	R134a	120/60/1/12	90	40.8	SD07R-20				
Two	3.5	0.24	2.9	11.0			1/4" (F) NPT	6.18 x 5.59 x 5" 15.7 x 14.2 x 12.7 cm	23.2 x 16.2 x 16.2" 58.9 x 41.1 x 41.1 cm	I (NFL)	•	•	•	95°	35°	R134a	120/60/1/12	90	40.8	SD7LR-20				
Two	3.5	0.24	2.9	11.0			1/4" (F) NPT	8.35 x 10.88 x 5.5" 21.2 x 27.6 x 14 cm	22.4 x 14.5 x 26.9" 56.9 x 36.8 x 68.3 cm	I (NFL)	•	•	•	95°	35°	R134a	120/60/1/13	118	53.5	SD15R-30				

# Technical Specifications

## Refrigerated Circulating Baths, 60 Hz Models

Model	Description	Catalog Page Number	Controller Type	Temperature Range		Temperature Stability		Display Resolution		Reservoir Capacity gal/ltr	Cooling Capacity @ (W)				Heater Wattage	Display/Interface	Pump Type
				°F	°C	°F	°C	Set	Read		100°C	20°C	0°C	-20°C			
SD20R-30	-30, 20 L Ref. Circulator	42-43	Standard Digital	-22° to 338°	-30° to 170°	±0.08°	±0.04°	0.1	0.1	5.28/20.0	915	915	505	165	1100	3.75" Touch-Pad LCD	Pressure
SD28R-30	-30, 28 L Ref. Circulator	42-43	Standard Digital	-22° to 338°	-30° to 170°	±0.08°	±0.04°	0.1	0.1	7.4/28.0	915	915	505	165	1100	3.75" Touch-Pad LCD	Pressure
MX07R-20	-20, 7 L Ref. Circulator	44-45	MX	-4° to 275°	-20° to 135°	±0.13°	±0.07°	0.1	0.1	1.85/7.0	200	200	120	30	1100	3.25" LCD	Pressure
MX7LR-20	-20, 7 L Ref. Circulator	44-45	MX	-4° to 275°	-20° to 135°	±0.13°	±0.07°	0.1	0.1	1.85/7.0	200	200	120	30	1100	3.25" LCD	Pressure
MX15R-30	-30, 15 L Ref. Circulator	44-45	MX	-22° to 275°	-30° to 135°	±0.13°	±0.07°	0.1	0.1	3.96/15.0	915	915	505	165	1100	3.25" LCD	Pressure
MX20R-30	-30, 20 L Ref. Circulator	44-45	MX	-22° to 275°	-30° to 135°	±0.13°	±0.07°	0.1	0.1	5.28/20.0	915	915	505	165	1100	3.25" LCD	Pressure

## Heated Circulating Baths, 60 Hz Models

Model	Description	Catalog Page Number	Controller Type	Temperature Range		Temperature Stability		Display Resolution		Reservoir Capacity gal/ltr	Tank Material	Heater Wattage	Display/Interface	Pump Type
				°F	°C	°F	°C	Set	Read					
PP07H200	200, 7 L Htg. Circulator	50-51	Performance Programmable	Ambient +20° to 392°	Ambient +10° to 200°	±0.01°	±0.005°	0.01	0.001	1.85/7	Stainless Steel	1100	4.3" SmartTouch Touchscreen	Pressure/Suction
PPI5H200	200, 15 L Htg. Circulator	50-51	Performance Programmable	Ambient +20° to 392°	Ambient +10° to 200°	±0.01°	±0.005°	0.01	0.001	3.96/15	Stainless Steel	1100	4.3" SmartTouch Touchscreen	Pressure/Suction
PP20H200	200, 20 L Htg. Circulator	50-51	Performance Programmable	Ambient +20° to 392°	Ambient +10° to 200°	±0.01°	±0.005°	0.01	0.001	5.28/20	Stainless Steel	1100	4.3" SmartTouch Touchscreen	Pressure/Suction
PP28H200	200, 28 L Htg. Circulator	50-51	Performance Programmable	Ambient +20° to 392°	Ambient +10° to 200°	±0.01°	±0.005°	0.01	0.001	7.4/28	Stainless Steel	1100	4.3" SmartTouch Touchscreen	Pressure/Suction
AP07H200	200, 7 L Htg. Circulator	52-53	Advanced Programmable	Ambient +20° to 392°	Ambient +10° to 200°	±0.02°	±0.01°	0.01	0.001	1.85/7	Stainless Steel	1100	4.3" SmartTouch Touchscreen	Pressure/Suction
API5H200	200, 15 L Htg. Circulator	52-53	Advanced Programmable	Ambient +20° to 392°	Ambient +10° to 200°	±0.02°	±0.01°	0.01	0.001	3.96/15	Stainless Steel	1100	4.3" SmartTouch Touchscreen	Pressure/Suction
AP20H200	200, 20 L Htg. Circulator	52-53	Advanced Programmable	Ambient +20° to 392°	Ambient +10° to 200°	±0.02°	±0.01°	0.01	0.001	5.28/20	Stainless Steel	1100	4.3" SmartTouch Touchscreen	Pressure/Suction
AP28H200	200, 28 L Htg. Circulator	52-53	Advanced Programmable	Ambient +20° to 392°	Ambient +10° to 200°	±0.02°	±0.01°	0.01	0.001	7.4/28	Stainless Steel	1100	4.3" SmartTouch Touchscreen	Pressure/Suction
PD07H200	200, 7 L Htg. Circulator	54-55	Performance Digital	Ambient +20° to 392°	Ambient +10° to 200°	±0.01°	±0.005°	0.01	0.001	1.85/7	Stainless Steel	1100	4.3" SmartTouch Touchscreen	Pressure/Suction
PDI5H200	200, 15 L Htg. Circulator	54-55	Performance Digital	Ambient +20° to 392°	Ambient +10° to 200°	±0.01°	±0.005°	0.01	0.001	3.96/15	Stainless Steel	1100	4.3" SmartTouch Touchscreen	Pressure/Suction
PD20H200	200, 20 L Htg. Circulator	54-55	Performance Digital	Ambient +20° to 392°	Ambient +10° to 200°	±0.01°	±0.005°	0.01	0.001	5.28/20	Stainless Steel	1100	4.3" SmartTouch Touchscreen	Pressure/Suction
PD28H200	200, 28 L Htg. Circulator	54-55	Performance Digital	Ambient +20° to 392°	Ambient +10° to 200°	±0.01°	±0.005°	0.01	0.001	7.4/28	Stainless Steel	1100	4.3" SmartTouch Touchscreen	Pressure/Suction
AD07H200	200, 7 L Htg. Circulator	56-57	Advanced Digital	Ambient +20° to 392°	Ambient +10° to 200°	±0.02°	±0.01°	0.01	0.01	1.85/7	Stainless Steel	1100	3.75" Touch-Pad LCD	Pressure/Suction
ADI5H200	200, 15 L Htg. Circulator	56-57	Advanced Digital	Ambient +20° to 392°	Ambient +10° to 200°	±0.02°	±0.01°	0.01	0.01	3.96/15	Stainless Steel	1100	3.75" Touch-Pad LCD	Pressure/Suction
AD20H200	200, 20 L Htg. Circulator	56-57	Advanced Digital	Ambient +20° to 392°	Ambient +10° to 200°	±0.02°	±0.01°	0.01	0.01	5.28/20	Stainless Steel	1100	3.75" Touch-Pad LCD	Pressure/Suction
AD28H200	200, 28 L Htg. Circulator	56-57	Advanced Digital	Ambient +20° to 392°	Ambient +10° to 200°	±0.02°	±0.01°	0.01	0.01	7.4/28	Stainless Steel	1100	3.75" Touch-Pad LCD	Pressure/Suction
SD07H170	170, 7 L Htg. Circulator	58-59	Standard Digital	Ambient +20° to 338°	Ambient +10° to 170°	±0.08°	±0.04°	0.1	0.1	1.85/7	Stainless Steel	1100	3.75" Touch-Pad LCD	Pressure
SD15H170	170, 15 L Htg. Circulator	58-59	Standard Digital	Ambient +20° to 338°	Ambient +10° to 170°	±0.08°	±0.04°	0.1	0.1	3.96/15	Stainless Steel	1100	3.75" Touch-Pad LCD	Pressure
SD20H170	170, 20 L Htg. Circulator	58-59	Standard Digital	Ambient +20° to 338°	Ambient +10° to 170°	±0.08°	±0.04°	0.1	0.1	5.28/20	Stainless Steel	1100	3.75" Touch-Pad LCD	Pressure
SD28H170	170, 28 L Htg. Circulator	58-59	Standard Digital	Ambient +20° to 338°	Ambient +10° to 170°	±0.08°	±0.04°	0.1	0.1	7.4/28	Stainless Steel	1100	3.75" Touch-Pad LCD	Pressure
MX07H135	135, 7 L Htg. Circulator	60-61	MX	Ambient +20° to 275°	Ambient +10° to 135°	±0.13°	±0.07°	0.1	0.1	1.85/7	Stainless Steel	1100	3.25" LCD	Pressure
MX15H135	135, 15 L Htg. Circulator	60-61	MX	Ambient +20° to 275°	Ambient +10° to 135°	±0.13°	±0.07°	0.1	0.1	3.96/15	Stainless Steel	1100	3.25" LCD	Pressure
MX20H135	135, 20 L Htg. Circulator	60-61	MX	Ambient +20° to 275°	Ambient +10° to 135°	±0.13°	±0.07°	0.1	0.1	5.28/20	Stainless Steel	1100	3.25" LCD	Pressure
MX-CA	135, Immersion Circulator	66	MX Immersion	Ambient +20° to 275°	Ambient +10° to 135°	±0.13°	±0.07°	0.1	0.1	7.4/28 max	Stainless Steel	1100	3.25" LCD	Pressure

Pump Speeds	Maximum Pressure		Maximum Pressure Flow Rate		Maximum Suction Flow Rate		Process Connections	Working Access	Overall Dimensions	Flammability Class	Over-Temperature Protection/Failsafe Heater Control	Low Level Protection	Reservoir Drain	Maximum Ambient Temperature		Refrigerant	Electrical Requirements		Shipping Weight		Model
	psi	bar	gpm	l/min	gpm	l/min								°F	°C		VAC/Hz/Ph/A	lb	kg		
	L x W x D		L x W x H		DIN 12876-1																
Two	3.5	0.24	2.9	11.0	1/4" (F) NPT		9.85 x 12.45 x 5.5" 25 x 31.6 x 14 cm	24 x 16.6 x 26.9" 61 x 41.9 x 68.3 cm	I (NFL)	•	•	•	95°	35°	R134a	120/60/1/13	130	58.9	SD20R-30		
Two	3.5	0.24	2.9	11.0	1/4" (F) NPT		12.35 x 14.13 x 5.5" 31.4 x 35.9 x 14 cm	26.5 x 18 x 26.9" 67.2 x 45.7 x 68.3 cm	I (NFL)	•	•	•	95°	35°	R134a	120/60/1/13	146	66.1	SD28R-30		
One	1.8	0.12	3.4	12.8	1/2" O.D. Barbed Tubes		6.18 x 5.59 x 5" 15.7 x 14.2 x 12.7 cm	21.3 x 8.7 x 25.4" 54.1 x 22.1 x 64.5 cm	I (NFL)	•	•	•	95°	35°	R134a	120/60/1/12	84	38.1	MX07R-20		
One	1.8	0.12	3.4	12.8	1/2" O.D. Barbed Tubes		6.18 x 5.59 x 5" 15.7 x 14.2 x 12.7 cm	23.2 x 16.2 x 17.3" 58.9 x 41.1 x 43.9 cm	I (NFL)	•	•	•	95°	35°	R134a	120/60/1/12	84	38.1	MX7LR-20		
One	1.8	0.12	3.4	12.8	1/2" O.D. Barbed Tubes		8.35 x 10.88 x 5.5" 21.2 x 27.6 x 14 cm	22.4 x 14.5 x 28" 56.9 x 36.8 x 71.1 cm	I (NFL)	•	•	•	95°	35°	R134a	120/60/1/13	112	50.7	MX15R-30		
One	1.8	0.12	3.4	12.8	1/2" O.D. Barbed Tubes		9.85 x 12.45 x 5.5" 25 x 31.6 x 14 cm	24 x 16.5 x 28" 61 x 41.9 x 71.1 cm	I (NFL)	•	•	•	95°	35°	R134a	120/60/1/13	124	56.2	MX20R-30		

Pump Speeds	Maximum Pressure		Maximum Pressure Flow Rate		Maximum Suction Flow Rate		Process Connections	Working Access	Overall Dimensions	Flammability Class	Over-Temperature Protection/Failsafe Heater Control	Low Level Protection	Reservoir Drain	Cooling Coil	Maximum Ambient Temperature		Electrical Requirements	Shipping Weight		Model	
	psi	bar	gpm	l/min	gpm	l/min									°F	°C		VAC/Hz/Ph/A	lb		kg
	L x W x D		L x W x H		DIN 12876-1																
Variable	4.3	0.30	5.3	20.1	3.9	14.7	1/4" (F) NPT	6.18 x 5.59 x 5" 15.7 x 14.2 x 12.7 cm	19.6 x 8.7 x 16.1" 49.9 x 22.1 x 40.9 cm	III (FL)	•	•	•	95°	35°	120/60/1/10	45	20.4	PP07H200		
Variable	4.3	0.30	5.3	20.1	3.9	14.7	1/4" (F) NPT	8.35 x 10.88 x 5.5" 21.2 x 27.6 x 14 cm	22.4 x 14.5 x 16.6" 56.9 x 36.8 x 42.2 cm	III (FL)	•	•	•	95°	35°	120/60/1/10	62	28.1	PP15H200		
Variable	4.3	0.30	5.3	20.1	3.9	14.7	1/4" (F) NPT	9.85 x 12.45 x 5.5" 25 x 31.6 x 14 cm	24 x 16.5 x 16.6" 61 x 41.9 x 42.2 cm	III (FL)	•	•	•	95°	35°	120/60/1/10	70	31.7	PP20H200		
Variable	4.3	0.30	5.3	20.1	3.9	14.7	1/4" (F) NPT	12.35 x 14.13 x 5.5" 31.4 x 35.9 x 14 cm	26.5 x 18 x 16.6" 67.2 x 45.7 x 42.2 cm	III (FL)	•	•	•	95°	35°	120/60/1/10	82	37.1	PP28H200		
Variable	4.3	0.30	5.3	20.1	3.9	14.7	1/4" (F) NPT	6.18 x 5.59 x 5" 15.7 x 14.2 x 12.7 cm	19.6 x 8.7 x 16.1" 49.9 x 22.1 x 40.9 cm	III (FL)	•	•	•	95°	35°	120/60/1/10	42	19.0	AP07H200		
Variable	4.3	0.30	5.3	20.1	3.9	14.7	1/4" (F) NPT	8.35 x 10.88 x 5.5" 21.2 x 27.6 x 14 cm	22.4 x 14.5 x 16.6" 56.9 x 36.8 x 42.2 cm	III (FL)	•	•	•	95°	35°	120/60/1/10	62	28.1	AP15H200		
Variable	4.3	0.30	5.3	20.1	3.9	14.7	1/4" (F) NPT	9.85 x 12.45 x 5.5" 25 x 31.6 x 14 cm	24 x 16.5 x 16.6" 61 x 41.9 x 42.2 cm	III (FL)	•	•	•	95°	35°	120/60/1/10	70	31.7	AP20H200		
Variable	4.3	0.30	5.3	20.1	3.9	14.7	1/4" (F) NPT	12.35 x 14.13 x 5.5" 31.4 x 35.9 x 14 cm	26.5 x 18 x 16.6" 67.2 x 45.7 x 42.2 cm	III (FL)	•	•	•	95°	35°	120/60/1/10	82	37.1	AP28H200		
Variable	4.3	0.30	5.3	20.1	3.9	14.7	1/4" (F) NPT	6.18 x 5.59 x 5" 15.7 x 14.2 x 12.7 cm	19.6 x 8.7 x 16.1" 49.9 x 22.1 x 40.9 cm	III (FL)	•	•	•	95°	35°	120/60/1/10	42	19.0	PD07H200		
Variable	4.3	0.30	5.3	20.1	3.9	14.7	1/4" (F) NPT	8.35 x 10.88 x 5.5" 21.2 x 27.6 x 14 cm	22.4 x 14.5 x 16.6" 56.9 x 36.8 x 42.2 cm	III (FL)	•	•	•	95°	35°	120/60/1/10	62	28.1	PD15H200		
Variable	4.3	0.30	5.3	20.1	3.9	14.7	1/4" (F) NPT	9.85 x 12.45 x 5.5" 25 x 31.6 x 14 cm	24 x 16.5 x 16.6" 61 x 41.9 x 42.2 cm	III (FL)	•	•	•	95°	35°	120/60/1/10	70	31.7	PD20H200		
Variable	4.3	0.30	5.3	20.1	3.9	14.7	1/4" (F) NPT	12.35 x 14.13 x 5.5" 31.4 x 35.9 x 14 cm	26.5 x 18 x 16.6" 67.2 x 45.7 x 42.2 cm	III (FL)	•	•	•	95°	35°	120/60/1/10	82	37.1	PD28H200		
Variable	4.3	0.30	5.3	20.1	3.9	14.7	1/4" (F) NPT	6.18 x 5.59 x 5" 15.7 x 14.2 x 12.7 cm	19.6 x 8.7 x 16.1" 49.9 x 22.1 x 40.9 cm	III (FL)	•	•	•	95°	35°	120/60/1/10	42	19.0	AD07H200		
Variable	4.3	0.30	5.3	20.1	3.9	14.7	1/4" (F) NPT	8.35 x 10.88 x 5.5" 21.2 x 27.6 x 14 cm	22.4 x 14.5 x 16.6" 56.9 x 36.8 x 42.2 cm	III (FL)	•	•	•	95°	35°	120/60/1/10	62	28.1	AD15H200		
Variable	4.3	0.30	5.3	20.1	3.9	14.7	1/4" (F) NPT	9.85 x 12.45 x 5.5" 25 x 31.6 x 14 cm	24 x 16.5 x 16.6" 61 x 41.9 x 42.2 cm	III (FL)	•	•	•	95°	35°	120/60/1/10	70	31.7	AD20H200		
Variable	4.3	0.30	5.3	20.1	3.9	14.7	1/4" (F) NPT	12.35 x 14.13 x 5.5" 31.4 x 35.9 x 14 cm	26.5 x 18 x 16.6" 67.2 x 45.7 x 42.2 cm	III (FL)	•	•	•	95°	35°	120/60/1/10	82	37.1	AD28H200		
Two	3.5	0.24	2.9	11	1/4" (F) NPT		6.18 x 5.59 x 5" 15.7 x 14.2 x 12.7 cm	19.6 x 8.7 x 16.1" 49.9 x 22.1 x 40.9 cm	I (NFL)	•	•	•	95°	35°	120/60/1/10	42	19.0	SD07H170			
Two	3.5	0.24	2.9	11	1/4" (F) NPT		8.35 x 10.88 x 5.5" 21.2 x 27.6 x 14 cm	22.4 x 14.5 x 16.6" 56.9 x 36.8 x 42.2 cm	I (NFL)	•	•	•	95°	35°	120/60/1/10	62	28.1	SD15H170			
Two	3.5	0.24	2.9	11	1/4" (F) NPT		9.85 x 12.45 x 5.5" 25 x 31.6 x 14 cm	24 x 16.5 x 16.6" 61 x 41.9 x 42.2 cm	I (NFL)	•	•	•	95°	35°	120/60/1/10	70	31.7	SD20H170			
Two	3.5	0.24	2.9	11	1/4" (F) NPT		12.35 x 14.13 x 5.5" 31.4 x 35.9 x 14 cm	26.5 x 18 x 16.6" 67.2 x 45.7 x 42.2 cm	I (NFL)	•	•	•	95°	35°	120/60/1/10	82	37.1	SD28H170			
One	1.8	0.12	3.4	12.8	1/2" O.D. Barbed Tubes		6.18 x 5.59 x 5" 15.7 x 14.2 x 12.7 cm	19.6 x 8.7 x 17.2" 49.9 x 22.1 x 43.7 cm	I (NFL)	•	•	•	95°	35°	120/60/1/10	36	16.3	MX07H135			
One	1.8	0.12	3.4	12.8	1/2" O.D. Barbed Tubes		8.35 x 10.88 x 5.5" 21.2 x 27.6 x 14 cm	22.4 x 14.5 x 17.8" 56.9 x 36.8 x 45.2 cm	I (NFL)	•	•	•	95°	35°	120/60/1/10	56	25.4	MX15H135			
One	1.8	0.12	3.4	12.8	1/2" O.D. Barbed Tubes		9.85 x 12.45 x 5.5" 25 x 31.6 x 14 cm	24 x 16.5 x 17.8" 61 x 41.9 x 45.2 cm	I (NFL)	•	•	•	95°	35°	120/60/1/10	64	29.0	MX20H135			
One	1.8	0.12	3.4	12.8	1/2" O.D. Barbed Tubes		4.3 x 3.8 x 14.1" 10.9 x 9.7 x 35.8 cm		I (NFL)	•	•	•	95°	35°	120/60/1/10	10	4.5	MX-CA			

# Technical Specifications

## Open Bath Systems, 60 Hz Models

Model	Description	Catalog Page Number	Controller Type	Temperature Range		Temperature Stability		Display Resolution		Reservoir Capacity gal/ltr	Tank Material	Heater Wattage	Display/Interface	Pump Type
				°F	°C	°F	°C	Set	Read					
AP06SI50	6 L Open Bath System	62-63	Advanced Programmable	Ambient +20° to 302°	Ambient +10° to 150°	±0.02°	±0.01°	0.01	0.001	1.58/6	Stainless Steel	1100	4.3" SmartTouch Touchscreen	Pressure/Suction
API0SI50	10 L Open Bath System	62-63	Advanced Programmable	Ambient +20° to 302°	Ambient +10° to 150°	±0.02°	±0.01°	0.01	0.001	2.64/10	Stainless Steel	1100	4.3" SmartTouch Touchscreen	Pressure/Suction
AP20SI50	20 L Open Bath System	62-63	Advanced Programmable	Ambient +20° to 302°	Ambient +10° to 150°	±0.02°	±0.01°	0.01	0.001	5.28/20	Stainless Steel	1100	4.3" SmartTouch Touchscreen	Pressure/Suction
AP28SI50	28 L Open Bath System	62-63	Advanced Programmable	Ambient +20° to 302°	Ambient +10° to 150°	±0.02°	±0.01°	0.01	0.001	7.40/28	Stainless Steel	1100	4.3" SmartTouch Touchscreen	Pressure/Suction
AD06SI50	6 L Open Bath System	62-63	Advanced Digital	Ambient +20° to 302°	Ambient +10° to 150°	±0.02°	±0.01°	0.01	0.01	1.58/6	Stainless Steel	1100	3.75" Touch-Pad LCD	Pressure/Suction
AD10SI50	10 L Open Bath System	62-63	Advanced Digital	Ambient +20° to 302°	Ambient +10° to 150°	±0.02°	±0.01°	0.01	0.01	2.64/10	Stainless Steel	1100	3.75" Touch-Pad LCD	Pressure/Suction
AD20SI50	20 L Open Bath System	62-63	Advanced Digital	Ambient +20° to 302°	Ambient +10° to 150°	±0.02°	±0.01°	0.01	0.01	5.28/20	Stainless Steel	1100	3.75" Touch-Pad LCD	Pressure/Suction
AD28SI50	28 L Open Bath System	62-63	Advanced Digital	Ambient +20° to 302°	Ambient +10° to 150°	±0.02°	±0.01°	0.01	0.01	7.40/28	Stainless Steel	1100	3.75" Touch-Pad LCD	Pressure/Suction
MX06SI35	6 L Open Bath System	62-63	MX	Ambient +20° to 275°	Ambient +10° to 135°	±0.13°	±0.07°	0.1	0.1	1.58/6	Stainless Steel	1100	3.25" LCD	Pressure
MX10SI35	10 L Open Bath System	62-63	MX	Ambient +20° to 275°	Ambient +10° to 135°	±0.13°	±0.07°	0.1	0.1	2.64/10	Stainless Steel	1100	3.25" LCD	Pressure
MX20SI35	20 L Open Bath System	62-63	MX	Ambient +20° to 275°	Ambient +10° to 135°	±0.13°	±0.07°	0.1	0.1	5.28/20	Stainless Steel	1100	3.25" LCD	Pressure
MX28SI35	28 L Open Bath System	62-63	MX	Ambient +20° to 275°	Ambient +10° to 135°	±0.13°	±0.07°	0.1	0.1	7.40/28	Stainless Steel	1100	3.25" LCD	Pressure
AP08PI00	8 L Open Bath System	64-65	Advanced Programmable	Ambient +20° to 185°	Ambient +10° to 85°	±0.02°	±0.01°	0.01	0.001	2.11/8	Polycarbonate	1100	4.3" SmartTouch Touchscreen	Pressure/Suction
AP11PI00	11 L Open Bath System	64-65	Advanced Programmable	Ambient +20° to 185°	Ambient +10° to 85°	±0.02°	±0.01°	0.01	0.001	2.91/11	Polycarbonate	1100	4.3" SmartTouch Touchscreen	Pressure/Suction
AP14PI00	14 L Open Bath System	64-65	Advanced Programmable	Ambient +20° to 185°	Ambient +10° to 85°	±0.02°	±0.01°	0.01	0.001	3.70/14	Polycarbonate	1100	4.3" SmartTouch Touchscreen	Pressure/Suction
AP17PI00	17 L Open Bath System	64-65	Advanced Programmable	Ambient +20° to 185°	Ambient +10° to 85°	±0.02°	±0.01°	0.01	0.001	4.49/17	Polycarbonate	1100	4.3" SmartTouch Touchscreen	Pressure/Suction
AP23PI00	23 L Open Bath System	64-65	Advanced Programmable	Ambient +20° to 185°	Ambient +10° to 85°	±0.02°	±0.01°	0.01	0.001	6.08/23	Polycarbonate	1100	4.3" SmartTouch Touchscreen	Pressure/Suction
AP28PI00	28 L Open Bath System	64-65	Advanced Programmable	Ambient +20° to 185°	Ambient +10° to 85°	±0.02°	±0.01°	0.01	0.001	7.40/28	Polycarbonate	1100	4.3" SmartTouch Touchscreen	Pressure/Suction
MX08PI00	8 L Open Bath System	64-65	MX	Ambient +20° to 185°	Ambient +10° to 85°	±0.13°	±0.07°	0.1	0.1	2.11/8	Polycarbonate	1100	3.25" LCD	Pressure
MX11PI00	11 L Open Bath System	64-65	MX	Ambient +20° to 185°	Ambient +10° to 85°	±0.13°	±0.07°	0.1	0.1	2.91/11	Polycarbonate	1100	3.25" LCD	Pressure
MX14PI00	14 L Open Bath System	64-65	MX	Ambient +20° to 185°	Ambient +10° to 85°	±0.13°	±0.07°	0.1	0.1	3.70/14	Polycarbonate	1100	3.25" LCD	Pressure
MX17PI00	17 L Open Bath System	64-65	MX	Ambient +20° to 185°	Ambient +10° to 85°	±0.13°	±0.07°	0.1	0.1	4.49/17	Polycarbonate	1100	3.25" LCD	Pressure
MX23PI00	23 L Open Bath System	64-65	MX	Ambient +20° to 185°	Ambient +10° to 85°	±0.13°	±0.07°	0.1	0.1	6.08/23	Polycarbonate	1100	3.25" LCD	Pressure
MX28PI00	28 L Open Bath System	64-65	MX	Ambient +20° to 185°	Ambient +10° to 85°	±0.13°	±0.07°	0.1	0.1	7.40/28	Polycarbonate	1100	3.25" LCD	Pressure

Pump Speeds	Maximum Pressure		Maximum Pressure Flow Rate		Maximum Suction Flow Rate		Process Connections	Working Access	Overall Dimensions	Flammability Class	Over-Temperature Protection/Failsafe Heater Control	Low Level Protection	Reservoir Drain	Cooling Coil	Maximum Ambient Temperature		Electrical Requirements	Shipping Weight		Model
	psi	bar	gpm	l/min	gpm	l/min									L x W x D	L x W x H		DIN 12876-1	°F	
Variable	4.3	0.30	5.3	20.1	3.9	14.7	1/4" (F) NPT	3.9 x 4.3 x 6" 10 x 11 x 15.2 cm	13.4 x 8.1 x 14.9" 34 x 20.6 x 37.8 cm	I (NFL)	•	•		95°	35°	120/60/1/1/10	26	11.8	AP06S150	
Variable	4.3	0.30	5.3	20.1	3.9	14.7	1/4" (F) NPT	3.9 x 10.1 x 6" 9.9 x 25.5 x 15.2 cm	13.9 x 13.5 x 14.9" 35.3 x 34.2 x 37.8 cm	I (NFL)	•	•	Acc	95°	35°	120/60/1/1/10	45	20.4	API0S150	
Variable	4.3	0.30	5.3	20.1	3.9	14.7	1/4" (F) NPT	10.4 x 9 x 6" 26.4 x 22.8 x 15.2 cm	20.9 x 13.5 x 14.9" 53.1 x 34.2 x 37.8 cm	I (NFL)	•	•	Acc	95°	35°	120/60/1/1/10	60	27.2	AP20S150	
Variable	4.3	0.30	5.3	20.1	3.9	14.7	1/4" (F) NPT	10.1 x 8.4 x 8" 25.7 x 21.4 x 20.3 cm	20.9 x 13.5 x 16.9" 53.1 x 34.2 x 42.9 cm	I (NFL)	•	•	Acc	95°	35°	120/60/1/1/10	72	32.6	AP28S150	
Variable	4.3	0.30	5.3	20.1	3.9	14.7	1/4" (F) NPT	3.9 x 4.3 x 6" 10 x 11 x 15.2 cm	13.4 x 8.1 x 14.9" 34 x 20.6 x 37.8 cm	I (NFL)	•	•		95°	35°	120/60/1/1/10	26	11.8	AD06S150	
Variable	4.3	0.30	5.3	20.1	3.9	14.7	1/4" (F) NPT	3.9 x 10.1 x 6" 9.9 x 25.5 x 15.2 cm	13.9 x 13.5 x 14.9" 35.3 x 34.2 x 40.6 cm	I (NFL)	•	•	Acc	95°	35°	120/60/1/1/10	45	20.4	AD10S150	
Variable	4.3	0.30	5.3	20.1	3.9	14.7	1/4" (F) NPT	10.4 x 9 x 6" 26.4 x 22.8 x 15.2 cm	20.9 x 13.5 x 14.9" 53.1 x 34.2 x 37.8 cm	I (NFL)	•	•	Acc	95°	35°	120/60/1/1/10	60	27.2	AD20S150	
Variable	4.3	0.30	5.3	20.1	3.9	14.7	1/4" (F) NPT	10.1 x 8.4 x 8" 25.7 x 21.4 x 20.3 cm	20.9 x 13.5 x 16.9" 53.1 x 34.2 x 42.9 cm	I (NFL)	•	•	Acc	95°	35°	120/60/1/1/10	72	32.6	AD28S150	
One	1.8	0.12	3.4	12.8			1/2" O.D. Barbed Tubes	3.9 x 4.3 x 6" 10 x 11 x 15.2 cm	13.4 x 8.1 x 16" 34 x 20.6 x 40.6 cm	I (NFL)	•	•		95°	35°	120/60/1/1/10	20	9.1	MX06S135	
One	1.8	0.12	3.4	12.8			1/2" O.D. Barbed Tubes	3.9 x 10.1 x 6" 9.9 x 25.5 x 15.2 cm	13.9 x 13.5 x 16" 35.3 x 34.2 x 40.6 cm	I (NFL)	•	•	Acc	95°	35°	120/60/1/1/10	39	17.7	MX10S135	
One	1.8	0.12	3.4	12.8			1/2" O.D. Barbed Tubes	10.4 x 9 x 6" 26.4 x 22.8 x 15.2 cm	20.9 x 13.5 x 16" 53.1 x 34.2 x 40.6 cm	I (NFL)	•	•	Acc	95°	35°	120/60/1/1/10	54	24.5	MX20S135	
One	1.8	0.12	3.4	12.8			1/2" O.D. Barbed Tubes	10.1 x 8.4 x 8" 25.7 x 21.4 x 20.3 cm	20.9 x 13.5 x 18" 53.1 x 34.2 x 45.7 cm	I (NFL)	•	•	Acc	95°	35°	120/60/1/1/10	66	29.9	MX28S135	
Variable	4.3	0.30	5.3	20.1	3.9	14.7	1/4" (F) NPT	4.1 x 6.1 x 8" 10.5 x 15.6 x 20.3 cm	12.7 x 8.2 x 16.3" 32.2 x 20.8 x 41.3 cm	I (NFL)	•	•		95°	35°	120/60/1/1/10	22	10.0	AP08P100	
Variable	4.3	0.30	5.3	20.1	3.9	14.7	1/4" (F) NPT	8.3 x 6.1 x 8" 21 x 15.6 x 20.3 cm	16.8 x 8.2 x 16.3" 42.7 x 20.8 x 41.3 cm	I (NFL)	•	•		95°	35°	120/60/1/1/10	27	12.2	AP11P100	
Variable	4.3	0.30	5.3	20.1	3.9	14.7	1/4" (F) NPT	12.4 x 6.1 x 8" 31.4 x 15.6 x 20.3 cm	20.9 x 8.2 x 16.3" 53.2 x 20.8 x 41.3 cm	I (NFL)	•	•		95°	35°	120/60/1/1/10	30	13.6	AP14P100	
Variable	4.3	0.30	5.3	20.1	3.9	14.7	1/4" (F) NPT	4.1 x 12 x 8" 10.5 x 30.5 x 20.3 cm	13.9 x 13.6 x 16.3" 35.3 x 34.5 x 41.3 cm	I (NFL)	•	•	Acc	95°	35°	120/60/1/1/10	38	17.2	AP17P100	
Variable	4.3	0.30	5.3	20.1	3.9	14.7	1/4" (F) NPT	8.3 x 12 x 8" 21 x 30.5 x 20.3 cm	18 x 13.6 x 16.3" 45.7 x 34.5 x 41.3 cm	I (NFL)	•	•	Acc	95°	35°	120/60/1/1/10	51	23.1	AP23P100	
Variable	4.3	0.30	5.3	20.1	3.9	14.7	1/4" (F) NPT	12.4 x 12 x 8" 31.5 x 30.5 x 20.3 cm	22.1 x 13.6 x 16.3" 56.2 x 34.5 x 41.3 cm	I (NFL)	•	•	Acc	95°	35°	120/60/1/1/10	62	28.1	AP28P100	
One	1.8	0.12	3.4	12.8			1/2" O.D. Barbed Tubes	4.1 x 6.1 x 8" 10.5 x 15.6 x 20.3 cm	12.7 x 8.2 x 17.4" 32.2 x 20.8 x 44.1 cm	I (NFL)	•	•		95°	35°	120/60/1/1/10	16	7.2	MX08P100	
One	1.8	0.12	3.4	12.8			1/2" O.D. Barbed Tubes	8.3 x 6.1 x 8" 21 x 15.6 x 20.3 cm	16.8 x 8.2 x 17.4" 42.7 x 20.8 x 44.1 cm	I (NFL)	•	•		95°	35°	120/60/1/1/10	21	9.5	MX11P100	
One	1.8	0.12	3.4	12.8			1/2" O.D. Barbed Tubes	12.4 x 6.1 x 8" 31.4 x 15.6 x 20.3 cm	20.9 x 8.2 x 17.4" 53.2 x 20.8 x 44.1 cm	I (NFL)	•	•		95°	35°	120/60/1/1/10	24	10.9	MX14P100	
One	1.8	0.12	3.4	12.8			1/2" O.D. Barbed Tubes	4.1 x 12 x 8" 10.5 x 30.5 x 20.3 cm	13.9 x 13.6 x 17.4" 35.3 x 34.5 x 44.1 cm	I (NFL)	•	•	Acc	95°	35°	120/60/1/1/10	32	14.5	MX17P100	
One	1.8	0.12	3.4	12.8			1/2" O.D. Barbed Tubes	8.3 x 12 x 8" 21 x 30.5 x 20.3 cm	18 x 13.6 x 17.4" 45.7 x 34.5 x 44.1 cm	I (NFL)	•	•	Acc	95°	35°	120/60/1/1/10	45	20.4	MX23P100	
One	1.8	0.12	3.4	12.8			1/2" O.D. Barbed Tubes	12.4 x 12 x 8" 31.5 x 30.5 x 20.3 cm	22.1 x 13.6 x 17.4" 56.2 x 34.5 x 44.1 cm	I (NFL)	•	•	Acc	95°	35°	120/60/1/1/10	56	25.4	MX28P100	

# Technical Specifications

## Specialty Products, 60 Hz Models

Model	Description	Catalog Page Number	Controller Type	Temperature Range		Temperature Stability		Display Resolution		Reservoir Capacity gal/ltr	Tank Material	Heater Wattage	Display/Interface	Pump Type
				°F	°C	°F	°C	Set	Read					
PP75R-20-A13D	75 L, Ref. Circulator	74	Performance Programmable	-4° to 212°	-20° to 100°	±0.01°	±0.005°	0.01	0.001	19.81/75	Stainless steel	2200	4.3" SmartTouch Touchscreen	Pressure/Suction
AP29VB5R-A11B	Viscosity Bath, 29 L, 5 Round	70-71	Advanced Programmable	Ambient +20° to 185°	Ambient +10° to 85°	±0.02°	±0.01°	0.01	0.001	7.66/29	Polycarbonate	1100	4.3" SmartTouch Touchscreen	Pressure/Suction
AP29VB3S-A11B	Viscosity Bath, 29 L, 3 Square	70-71	Advanced Programmable	Ambient +20° to 185°	Ambient +10° to 85°	±0.02°	±0.01°	0.01	0.001	7.66/29	Polycarbonate	1100	4.3" SmartTouch Touchscreen	Pressure/Suction
AD29VB5R-A11B	Viscosity Bath, 29 L, 5 Round	70-71	Advanced Digital	Ambient +20° to 185°	Ambient +10° to 85°	±0.02°	±0.01°	0.01	0.01	7.66/29	Polycarbonate	1100	3.75" Touch-Pad LCD	Pressure/Suction
AD29VB3S-A11B	Viscosity Bath, 29 L, 3 Square	70-71	Advanced Digital	Ambient +20° to 185°	Ambient +10° to 85°	±0.02°	±0.01°	0.01	0.01	7.66/29	Polycarbonate	1100	3.75" Touch-Pad LCD	Pressure/Suction
SD29VB5R-A11B	Viscosity Bath, 29 L, 5 Round	70-71	Standard Digital	Ambient +20° to 185°	Ambient +10° to 85°	±0.08°	±0.04°	0.01	0.01	7.66/29	Polycarbonate	1100	3.75" Touch-Pad LCD	Pressure
SD29VB3S-A11B	Viscosity Bath, 29 L, 3 Square	70-71	Standard Digital	Ambient +20° to 185°	Ambient +10° to 85°	±0.08°	±0.04°	0.01	0.01	7.66/29	Polycarbonate	1100	3.75" Touch-Pad LCD	Pressure
MX17VB6G-A11B	Viscosity Bath, 17 L, 6 Round	70-71	MX	Ambient +20° to 275°	Ambient +10° to 135°	±0.13°	±0.07°	0.1	0.1	4.49/17	Glass	1100	3.25" LCD	Pressure
MX27VB6G-A11B	Viscosity Bath, 27 L, 6 Round	70-71	MX	Ambient +20° to 275°	Ambient +10° to 135°	±0.13°	±0.07°	0.1	0.1	7.13/27	Glass	1100	3.25" LCD	Pressure
PPI5HCAL-A11B	Calibration Bath, 15 L, Htg.	72-73	Performance Programmable	Ambient + 20° to 392°	Ambient + 10° to 200°	±0.01°	±0.005°	0.01	0.001	3.96/15	Stainless Steel	1100	4.3" SmartTouch Touchscreen	Pressure/Suction
PD15HCAL-A11B	Calibration Bath, 15 L, Htg.	72-73	Performance Digital	Ambient + 20° to 392°	Ambient + 10° to 200°	±0.01°	±0.005°	0.01	0.001	3.96/15	Stainless Steel	1100	4.3" SmartTouch Touchscreen	Pressure/Suction
PPI5RCAL-A11B	Calibration Bath, 15 L, Ref.	72-73	Performance Programmable	-22° to 392°	-30° to 200°	±0.01°	±0.005°	0.01	0.001	3.96/15	Stainless Steel	1100	4.3" SmartTouch Touchscreen	Pressure/Suction
PD15RCAL-A11B	Calibration Bath, 15 L, Ref.	72-73	Performance Digital	-22° to 392°	-30° to 200°	±0.01°	±0.005°	0.01	0.001	3.96/15	Stainless Steel	1100	4.3" SmartTouch Touchscreen	Pressure/Suction
6260BICRY10C	Cryoprecipitate Bath	75	Digital	Set-point Fixed @ 39.2°F	Set-point Fixed @ 4°C	±0.2°	±0.1°C	0.1	0.1	13.8/52	Stainless Steel		Two Digital Readouts	
T13RSA11B	13 L Refrigerated Open Bath	75		32° to 302°F	0° to 150°C					3.4/13	Stainless Steel			
HBATH-60-A11B	Histology Bath	76		Fixed at -76°	Fixed at -60°					0.50/1.9	Stainless Steel			
HPLAT-30-A11B	Histology Freeze Plate	76		Fixed at -30°	Fixed at -34.4°									
MX28C135-A11B	Coliform Bath, 28 L	77	MX	Ambient +20° to 275°	Ambient +10° to 135°	±0.13°	±0.07°	0.1	0.1	7.40/28	Stainless Steel	1100	3.25" LCD	Pressure

## Low Temperature Coolers, 60 Hz Models

Model	Description	Catalog Page Number	Temperature Range		Temperature Control		Temperature Readout	Cooling Capacity @ (W)			
			°F	°C	°F	°C		-100°C	-80°C	-65°C	-40°C
IP-100 (RC)	Immersion Probe 3" Rigid Coil	114-115	-148° to -76°	-100° to -60°	Fixed @ -148°	Fixed @ -100°	•	0	35	85	
IP-100 (CF)	Immersion Probe Rigid Cold Finger	114-115	-148° to -76°	-100° to -60°	Fixed @ -148°	Fixed @ -100°	•	0	35	85	
IP-100 (FP)	Immersion Probe Flexible Cold Finger	114-115	-148° to -76°	-100° to -60°	Fixed @ -148°	Fixed @ -100°	•	0	35	85	
IP-80 (RC)	Immersion Probe 1.5" Rigid Coil	114-115	-112° to -40°	-80° to -40°	Fixed @ -112°	Fixed @ -80°	•		85	150	
IP-60 (RC)	Immersion Probe 3" Rigid Coil	114-115	-76° to -4°	-60° to -20°	Fixed @ -76°	Fixed @ -60°			0	35	
IP-35 (RC)	Immersion Probe 3" Rigid Coil	114-115	-31° to +104°	-35° to +40°	Fixed @ -31°	Fixed @ -35°					
IP-35 (RC)	Immersion Probe 1.75" Rigid Coil	114-115	-31° to +104°	-35° to +40°	Fixed @ -31°	Fixed @ -35°					
FT-25	Flow-Through	115	-13° to +104°	-25° to +40°	Fixed @ -13°	Fixed @ -25°					



Pump Speeds	Maximum Pressure		Maximum Pressure Flow Rate		Maximum Suction Flow Rate		Process Connections	Working Access	Overall Dimensions	Flammability Class	Over-Temperature Protection/Failsafe Heater Control	Low Level Protection	Reservoir Drain Cooling Coil	Maximum Ambient Temperature		Electrical Requirements	Shipping Weight		Model
	psi	bar	gpm	l/min	gpm	l/min								L x W x D	L x W x H		°F	°C	
Variable	4.3	0.30	5.3	20.1	3.9	14.7	1/4" (F) NPT	21.6 x 15.7 x 9.4" 54.9 x 39.8 x 23.9 cm	35.8 x 22.4 x 42.1" 90.9 x 56.9 x 107 cm	III (FL)	•	•	•	95°	35°	208-240/50-60/1/13	200	90.6	PP75R-20-A13D
Variable	4.3	0.30	5.3	20.1	3.9	14.7	1/4" (F) NPT	(5) x 2 Ø x 11.25" (5) x 5.1 Ø x 28.6 cm	21.4 x 9 x 20.7" 54.4 x 22.9 x 52.6 cm	I (NFL)	•	•	•	95°	35°	120/60/1/10	75	34.0	AP29VB5R-A11B
Variable	4.3	0.30	5.3	20.1	3.9	14.7	1/4" (F) NPT	(3) x 3.5 x 3.5 x 11.25" (3) x 8.9 x 8.9 x 28.6 cm	21.4 x 9 x 20.7" 54.4 x 22.9 x 52.6 cm	I (NFL)	•	•	•	95°	35°	120/60/1/10	75	34.0	AP29VB3S-A11B
Variable	4.3	0.30	5.3	20.1	3.9	14.7	1/4" (F) NPT	(5) x 2 Ø x 11.25" (5) x 5.1 Ø x 28.6 cm	21.4 x 9 x 20.7" 54.4 x 22.9 x 52.6 cm	I (NFL)	•	•	•	95°	35°	120/60/1/10	75	34.0	AD29VB5R-A11B
Variable	4.3	0.30	5.3	20.1	3.9	14.7	1/4" (F) NPT	(3) x 3.5 x 3.5 x 11.25" (3) x 8.9 x 8.9 x 28.6 cm	21.4 x 9 x 20.7" 54.4 x 22.9 x 52.6 cm	I (NFL)	•	•	•	95°	35°	120/60/1/10	75	34.0	AD29VB3S-A11B
Two	3.5	0.24	2.9	11			1/4" (F) NPT	(5) x 2 Ø x 11.25" (5) x 5.1 Ø x 28.6 cm	21.4 x 9 x 20.7" 54.4 x 22.9 x 52.6 cm	I (NFL)	•	•	•	95°	35°	120/60/1/10	75	34.0	SD29VB5R-A11B
Two	3.5	0.24	2.9	11			1/4" (F) NPT	(3) x 3.5 x 3.5 x 11.25" (3) x 8.9 x 8.9 x 28.6 cm	21.4 x 9 x 20.7" 54.4 x 22.9 x 52.6 cm	I (NFL)	•	•	•	95°	35°	120/60/1/10	75	34.0	SD29VB3S-A11B
One	1.8	0.12	3.4	12.8			1/2" O.D. Barbed Tubes	(6) x 2 Ø x 11" (6) x 5.1 Ø x 27.9 cm	12.5 Ø x 20.5" 31.8 Ø x 52.1 cm	I (NFL)	•	•	•	95°	35°	120/60/1/10	35	15.9	MX17VB6G-A11B
One	1.8	0.12	3.4	12.8			1/2" O.D. Barbed Tubes	(6) x 2 Ø x 17" (6) x 5.1 Ø x 43.2 cm	12.5 Ø x 26.4" 31.8 Ø x 67.0 cm	I (NFL)	•	•	•	95°	35°	120/60/1/10	45	20.4	MX27VB6G-A11B
Variable	4.3	0.30	5.3	20.1	3.9	14.7	1/4" (F) NPT	4.6 Ø x 11" 11.7 Ø x 28 cm	21.3 x 8.7 x 24.3" 54.1 x 22.1 x 61.7 cm	III (FL)	•	•	•	95°	35°	120/60/1/12	50	22.7	PP15HCAL-A11B
Variable	4.3	0.30	5.3	20.1	3.9	14.7	1/4" (F) NPT	4.6 Ø x 11" 11.7 Ø x 28 cm	21.3 x 8.7 x 24.3" 54.1 x 22.1 x 61.7 cm	III (FL)	•	•	•	95°	35°	120/60/1/12	50	22.7	PD15HCAL-A11B
Variable	4.3	0.30	5.3	20.1	3.9	14.7	1/4" (F) NPT	4.6 Ø x 11" 11.7 Ø x 28 cm	21.3 x 8.7 x 30.5" 54.1 x 22.1 x 77.5 cm	III (FL)	•	•	•	95°	35°	120/60/1/13	100	45.3	PP15RCAL-A11B
Variable	4.3	0.30	5.3	20.1	3.9	14.7	1/4" (F) NPT	4.6 Ø x 11" 11.7 Ø x 28 cm	21.3 x 8.7 x 30.5" 54.1 x 22.1 x 77.5 cm	III (FL)	•	•	•	95°	35°	120/60/1/13	100	45.3	PD15RCAL-A11B
								20.6 x 13 x 12" 52.4 x 33 x 30.5 cm	28 x 14.5 x 36.6" 71.1 x 37 x 93 cm					95°	35°	120/60/1/11.25	200	90.6	6260B1CRY10C
								9 x 11.75 x 7.75" 22.9 x 29.8 x 19.7 cm	13.5 x 22 x 10" 34.3 x 55.9 x 25.4 cm	I (NFL)				95°	35°	120/60/1/3	58	26	T13RSA11B
								4.8 Ø x 6.6" 12.2 Ø x 16.8 cm	22.75 x 11 x 11" 57.8 x 27.9 x 27.9 cm					95°	35°	120/60/1/5	75	34.0	HBATH-60-A11B
								14.5 x 9.4" 36.8 x 23.8 cm	15.9 x 18.4 x 10.5" 40.3 x 46.7 x 26.7 cm					95°	35°	120/60/1/6.5	76	34.4	HPLAT-30-A11B
One	1.8	0.12	3.4	12.8			1/2" O.D. Barbed Tubes	11.8 x 12.9 x 8.3" 30 x 32.8 x 21.1 cm	13.9 x 21.5 x 18" 35.3 x 54.6 x 45.7 cm	I (NFL)	•	•	•	95°	35°	120/60/1/10	66	29.9	MX28C135-A11B

Cooling Capacity @ (W)				Process Connections				Overall Dimensions L x W x H	Maximum Ambient Temperature		Refrigerant	Electrical Requirements VAC/Hz/Ph/A	Shipping Weight		Model
-30°C	-20°C	-10°C	0°C	+10°C	+20°C	+30°C	+40°C		°F	°C			lb	kg	
								20.1 x 15 x 22.3" 51.1 x 38.1 x 56.6 cm	86°	30°	R404A & R508B	120/60/1/11.5	162	73.5	IP-100 (RC)
								20.1 x 15 x 22.3" 51.1 x 38.1 x 56.6 cm	86°	30°	R404A & R508B	120/60/1/11.5	162	73.5	IP-100 (CF)
								20.1 x 15 x 22.3" 51.1 x 38.1 x 56.6 cm	86°	30°	R404A & R508B	120/60/1/11.5	162	73.5	IP-100 (FP)
								20.1 x 15 x 22.3" 51.1 x 38.1 x 56.6 cm	86°	30°	R404A & R508B	120/60/1/11.5	162	73.5	IP-80 (RC)
50	75							11 x 10 x 9" 27.9 x 25.4 x 22.9 cm	86°	30°	R502 & R508B	120/60/1/5	49	22.0	IP-60 (RC)
117	164	273	454	757	1,081	1,298	1,427	17 x 14 x 14" 43.2 x 35.6 x 35.6 cm	86°	30°	R134a	120/60/1/5	76	34.0	IP-35 (RC)
106	152	253	421	703	1,004	1,205	1,326	17 x 14 x 14" 43.2 x 35.6 x 35.6 cm	86°	30°	R134a	120/60/1/5	78	35.4	IP-35 (RC)
	117	260	322	537	745	921	1,012	17 x 14 x 14" 43.2 x 35.6 x 35.6 cm	86°	30°	R134a	120/60/1/5	73	33.1	FT-25

# Technical Specifications

## General Purpose Water Baths, 60 Hz Models

Model	Description	Catalog Page Number	Controller Type	Temperature Range		Temperature Stability		Reservoir Capacity gal/ltr	Tank Material
				°F	°C	°F	°C		
WD02A11B	General Purpose Water Bath, Digital, 2 L	86-87	Digital	Ambient +10° to 212°	Ambient +5° to 100°	±0.5°	±0.25°	0.53/2	Stainless Steel
WD2SA11B	General Purpose Water Bath, Digital, 2 L	86-87	Digital	Ambient +10° to 212°	Ambient +5° to 100°	±0.5°	±0.25°	0.53/2	Stainless Steel
WD05A11B	General Purpose Water Bath, Digital, 5 L	86-87	Digital	Ambient +10° to 212°	Ambient +5° to 100°	±0.5°	±0.25°	1.32/5	Stainless Steel
WD10A11B	General Purpose Water Bath, Digital, 10 L	86-87	Digital	Ambient +10° to 212°	Ambient +5° to 100°	±0.5°	±0.25°	2.64/10	Stainless Steel
WD20A11B	General Purpose Water Bath, Digital, 20 L	86-87	Digital	Ambient +10° to 212°	Ambient +5° to 100°	±0.5°	±0.25°	5.28/20	Stainless Steel
WD28A11B	General Purpose Water Bath, Digital, 28 L	86-87	Digital	Ambient +10° to 212°	Ambient +5° to 100°	±0.5°	±0.25°	7.40/28	Stainless Steel
WAO2A11B	General Purpose Water Bath, Economy, 2 L	88-89	Dial	Ambient +10° to 212°	Ambient +5° to 100°	±0.5°	±0.25°	0.53/2	Stainless Steel
WA2SA11B	General Purpose Water Bath, Economy, 2 L	88-89	Dial	Ambient +10° to 212°	Ambient +5° to 100°	±0.5°	±0.25°	0.53/2	Stainless Steel
WAO5A11B	General Purpose Water Bath, Economy, 5 L	88-89	Dial	Ambient +10° to 212°	Ambient +5° to 100°	±0.5°	±0.25°	1.32/5	Stainless Steel
WA10A11B	General Purpose Water Bath, Economy, 10 L	88-89	Dial	Ambient +10° to 212°	Ambient +5° to 100°	±0.5°	±0.25°	2.64/10	Stainless Steel
WA20A11B	General Purpose Water Bath, Economy, 20 L	88-89	Dial	Ambient +10° to 212°	Ambient +5° to 100°	±0.5°	±0.25°	5.28/20	Stainless Steel
WA28A11B	General Purpose Water Bath, Economy, 28 L	88-89	Dial	Ambient +10° to 212°	Ambient +5° to 100°	±0.5°	±0.25°	7.40/28	Stainless Steel

## Recirculating Coolers, 60 Hz Models

Model	Description	Catalog Page Number	Temperature Range		Temperature Stability		Reservoir Capacity gal/ltr	Cooling Capacity @ 10-11°C ΔT (W)	Facility Water In @ 20°C (W)	Pump Type
			°F	°C	°F	°C				
3370P9A11B	Liquid-to-Air Cooler, Positive Displacement	107	Ambient +10° to 158°	Ambient +5° to 70°C	N/A	N/A	1.11/4.2	4,000		Positive Displacement
3370TBA11B	Liquid-to-Air Cooler, Turbine	107	Ambient +10° to 158°	Ambient +5° to 70°C	N/A	N/A	1.11/4.2	4,000		Turbine
4150T21A330D	Liquid-to-Liquid Cooler	108	Facility water +20° to 140°	Facility water +10° to 60°	±0.8°	±0.4°	1.11/4.2	10,000	10 lpm	Turbine

Heater Wattage	Working Access		Overall Dimensions		Over-Temperature Protection	Maximum Ambient Temperature		Electrical Requirements VAC/Hz/Ph/A	Shipping Weight		Model
	L x W x D	L x W x H	L x W x H	°F		°C	lb		kg		
300	3.9 x 4.3 x 5.5" 9.9 x 10.9 x 14 cm	10.2 x 8 x 11.8" 25.9 x 20.3 x 30 cm	•	86°	30°	120/60/1/2.5	10	4.5	WD02A11B		
300	5 x 10.8 x 1.9" 12.7 x 27.4 x 4.8 cm	10.6 x 13.6 x 12" 26.9 x 34.5 x 30.4 cm	•	86°	30°	120/60/1/2.5	10	4.5	WD2SA11B		
500	5 x 10.8 x 5.5" 12.7 x 27.4 x 14 cm	10.6 x 13.6 x 12" 26.9 x 34.5 x 30.4 cm	•	86°	30°	120/60/1/4.2	14	6.3	WD05A11B		
500	10.6 x 11.6 x 5.5" 26.9 x 29.5 x 14 cm	16.7 x 14.8 x 11.8" 42.4 x 37.6 x 30 cm	•	86°	30°	120/60/1/4.2	19	8.6	WD10A11B		
1000	9.5 x 17.5 x 5" 24.1 x 44.5 x 12.7 cm	16.4 x 21.6 x 12" 41.5 x 54.8 x 30.5 cm	•	86°	30°	120/60/1/8.3	26	11.8	WD20A11B		
1000	9.5 x 17.5 x 7" 24.1 x 44.5 x 17.8 cm	16.4 x 21.6 x 14.1" 41.5 x 54.8 x 35.8 cm	•	86°	30°	120/60/1/8.3	29	13.1	WD28A11B		
300	3.9 x 4.3 x 5.5" 9.9 x 10.9 x 14 cm	11 x 8 x 11.8" 27.7 x 20.3 x 30 cm	•	86°	30°	120/60/1/2.5	10	4.5	WA02A11B		
300	5 x 10.8 x 1.9" 12.7 x 27.4 x 4.8 cm	11.4 x 13.6 x 12" 28.9 x 34.5 x 30.4 cm	•	86°	30°	120/60/1/2.5	10	4.5	WA2SA11B		
500	5 x 10.8 x 5.5" 12.7 x 27.4 x 14 cm	11.4 x 13.6 x 12" 28.9 x 34.5 x 30.4 cm	•	86°	30°	120/60/1/4.2	14	6.3	WA05A11B		
500	10.6 x 11.6 x 5.5" 26.9 x 29.5 x 14 cm	17.5 x 14.8 x 11.8" 44.5 x 37.6 x 30 cm	•	86°	30°	120/60/1/4.2	19	8.6	WA10A11B		
1000	9.5 x 17.5 x 5" 24.1 x 44.5 x 12.7 cm	17.1 x 21.6 x 12" 43.4 x 54.8 x 30.5 cm	•	86°	30°	120/60/1/8.3	26	11.8	WA20A11B		
1000	9.5 x 17.5 x 7" 24.1 x 44.5 x 17.8 cm	17.1 x 21.6 x 14.1" 43.4 x 54.8 x 35.8 cm	•	86°	30°	120/60/1/8.3	29	13.1	WA28A11B		

Maximum Pump Pressure		Maximum Pump Flow		Process Connections	Overall Dimensions L x W x H	Maximum Ambient Temperature		Refrigerant	Electrical Requirements VAC/Hz/Ph/A	Shipping Weight		Model
psi	bar	gpm	l/min			°F	°C			lb	kg	
100	6.9	2.4	9.1	1/2" (F) NPT	20.5 x 15 x 22.3" 52 x 38.1 x 54.6 cm	95°	35°		120/60/1/5.5	132	59.9	3370P9A11B
62	4.3	5.4	20.5	1/2" (F) NPT	20.5 x 15 x 22.3" 52 x 38.1 x 54.6 cm	95°	35°		120/60/1/5.5	132	59.9	3370TBA11B
100	6.9	3.5	13.2	1/2" (F) NPT	27.6 x 14.5 x 22.6" 70.2 x 36.8 x 57.5 cm	95°	35°		208-240/50-60/1/3	175	79.5	4150T21A330D

# Technical Specifications

## Chillers: Benchtop, 6000 Series and DuraChill™, 60 Hz Models

Model	Description	Catalog Page Number	Temperature Range		Temperature Stability		Reservoir Capacity gal/ltr	Cooling Capacity @ (W)							
			°F	°C	°F	°C		50°C	40°C	30°C	20°C	10°C	0°C	-5°C	-10°C
LS51TX1A110C	Chiller, 1/2 HP, Recirculating	98-99	-4° to 104°	-20° to 40°	±0.2°	±0.1°	0.70/2.65	1,140	1,020	900	790	540	395	345	150
LS51MX1A110C	Chiller, 1/2 HP, Recirculating	98-99	-4° to 104°	-20° to 40°	±0.2°	±0.1°	0.70/2.65	1,610	1,460	1,290	1,130	750	600	475	260
LS51M11A110C	Chiller, 1/2 HP, Recirculating	98-99	-4° to 104°	-20° to 40°	±0.2°	±0.1°	0.70/2.65	1,550	1,380	1,160	1,030	680	510	435	230
LM61MX1A110C	Chiller, 1/3 HP, Recirculating	100	14 to 86°	-10° to 30°	±0.2°	±0.1°	0.70/2.65		540	420	340	250	210	170	
LM61GX1A110C	Chiller, 1/3 HP, Recirculating	100	14 to 86°	-10° to 30°	±0.2°	±0.1°	0.70/2.65		650	560	470	350	295	230	
MM71MX1A110C	Chiller, 1/10 HP, Recirculating	101	23 to 122°	-5° to 50°	±0.2°	±0.1°	0.70/2.65	535	505	465	435	305	195	115	
MM71GX1A110C	Chiller, 1/10 HP, Recirculating	101	23 to 122°	-5° to 50°	±0.2°	±0.1°	0.70/2.65	550	520	490	460	320	215	130	
6260T11A110B	Chiller, 1/4 HP, Recirculating	102-103	14° to 104°	-10° to 40°	±0.2°	±0.1°	1.1/4.2	1,175	1,025	850	600	400	230	65	
6360T11A120C	Chiller, 1/3 HP, Recirculating	102-103	14° to 104°	-10° to 40°	±0.2°	±0.1°	1.1/4.2	1,543	1,498	1,400	990	530	375	220	
6560T11A120C	Chiller, 1/2 HP, Recirculating	102-103	14° to 104°	-10° to 40°	±0.2°	±0.1°	1.1/4.2	1,874	1,819	1,700	1,150	750	525	300	
6760T21A130D	Chiller, 3/4 HP, Recirculating	102-103	14° to 104°	-10° to 40°	±0.2°	±0.1°	1.1/4.2	2,535	2,461	2,300	1,550	875	625	375	
6160T21A130D	Chiller, 1 HP, Recirculating	102-103	14° to 104°	-10° to 40°	±0.2°	±0.1°	1.1/4.2	3,196	3,103	2,900	1,925	1,000	725	450	
6260P11A110B	Chiller, 1/4 HP, Recirculating	102-103	14° to 104°	-10° to 40°	±0.2°	±0.1°	1.1/4.2	1,175	1,025	850	600	400	230	65	
6360P11A120C	Chiller, 1/3 HP, Recirculating	102-103	14° to 104°	-10° to 40°	±0.2°	±0.1°	1.1/4.2	1,543	1,498	1,400	990	530	375	220	
6560P11A120C	Chiller, 1/2 HP, Recirculating	102-103	14° to 104°	-10° to 40°	±0.2°	±0.1°	1.1/4.2	1,874	1,819	1,700	1,150	750	525	300	
6760P41A130D	Chiller, 3/4 HP, Recirculating	102-103	14° to 104°	-10° to 40°	±0.2°	±0.1°	1.1/4.2	2,535	2,461	2,300	1,550	875	625	375	
6160P41A130D	Chiller, 1 HP, Recirculating	102-103	14° to 104°	-10° to 40°	±0.2°	±0.1°	1.1/4.2	3,196	3,103	2,900	1,925	1,000	725	450	
6260M11A110B	Chiller, 1/4 HP, Recirculating	102-103	14° to 104°	-10° to 40°	±0.2°	±0.1°	1.1/4.2	1,275	1,125	950	700	300	225	150	
6360M11A110B	Chiller, 1/3 HP, Recirculating	102-103	14° to 104°	-10° to 40°	±0.2°	±0.1°	1.1/4.2	1,576	1,530	1,430	1,000	700	500	300	
6560M11A120C	Chiller, 1/2 HP, Recirculating	102-103	14° to 104°	-10° to 40°	±0.2°	±0.1°	1.1/4.2	1,984	1,926	1,800	1,250	850	625	400	
6760M21A130D	Chiller, 3/4 HP, Recirculating	102-103	14° to 104°	-10° to 40°	±0.2°	±0.1°	1.1/4.2	2,590	2,515	2,350	1,550	975	675	375	
6160M21A130D	Chiller, 1 HP, Recirculating	102-103	14° to 104°	-10° to 40°	±0.2°	±0.1°	1.1/4.2	3,196	3,103	2,900	1,835	1,100	775	450	
6880 (460V/3PH)	Chiller, 1.5 HP, Recirculating	104	41° to 95°	5° to 35°	±0.9°	±0.5°	3.5/13.25		5,564	5,200	3,640				
6870 (240V/3PH)	Chiller, 1.5 HP, Recirculating	104	41° to 95°	5° to 35°	±0.9°	±0.5°	3.5/13.25		5,564	5,200	3,640				
6860P46A270D	Chiller, 1.5 HP, Recirculating	104	41° to 95°	5° to 35°	±0.9°	±0.5°	3.5/13.25		5,564	5,200	3,640				
6960P46A270D	Chiller, 1.5 HP, Recirculating	104	41° to 95°	5° to 35°	±0.9°	±0.5°	3.5/13.25		6,771	6,328	4,430				
DCA200 (460V/3PH)	Chiller, 2 HP, Recirculating	105	41° to 95°	5° to 35°	±0.9°	±0.5°	7.00/26.5		7,490	7,000	4,900				
DCA200 (240V/3PH)	Chiller, 2 HP, Recirculating	105	41° to 95°	5° to 35°	±0.9°	±0.5°	7.00/26.5		7,490	7,000	4,900				
DCA200 (230V/1PH)	Chiller, 2 HP, Recirculating	105	41° to 95°	5° to 35°	±0.9°	±0.5°	7.00/26.5		7,490	7,000	4,900				
DCA300 (460V/3PH)	Chiller, 3 HP, Recirculating	105	41° to 95°	5° to 35°	±0.9°	±0.5°	7.00/26.5		11,235	10,500	7,350				
DCA300 (240V/3PH)	Chiller, 3 HP, Recirculating	105	41° to 95°	5° to 35°	±0.9°	±0.5°	7.00/26.5		11,235	10,500	7,350				
DCA300 (230V/1PH)	Chiller, 3 HP, Recirculating	105	41° to 95°	5° to 35°	±0.9°	±0.5°	7.00/26.5		11,235	10,500	7,350				
DCW300 (240V/3PH)	Chiller, 3 HP, Recirculating	105	41° to 95°	5° to 35°	±0.9°	±0.5°	7.00/26.5		11,702	10,936	7,655				
DA500 (460V/3PH)	Chiller, 5 HP, Recirculating	106	32° to 86°	0° to 30°	±2.0°	±1.11°	16.00/60.5		22,789	21,299	16,384	9,830			
DA500 (240V/3PH)	Chiller, 5 HP, Recirculating	106	32° to 86°	0° to 30°	±2.0°	±1.11°	16.00/60.5		22,789	21,299	16,384	9,830			
DA750 (460V/3PH)	Chiller, 7.5 HP, Recirculating	106	32° to 86°	0° to 30°	±2.0°	±1.11°	45.00/170		31,103	29,069	22,361	13,417			
DA750 (575V/3PH)	Chiller, 7.5 HP, Recirculating	106	32° to 86°	0° to 30°	±2.0°	±1.11°	45.00/170		31,103	29,069	22,361	13,417			
DA1000 (460V/3PH)	Chiller, 10 HP, Recirculating	106	32° to 86°	0° to 30°	±2.0°	±1.11°	45.00/170		46,509	43,467	33,436	20,062			
DA1000 (575V/3PH)	Chiller, 10 HP, Recirculating	106	32° to 86°	0° to 30°	±2.0°	±1.11°	45.00/170		46,509	43,467	33,436	20,062			

Compressor Size	Heater Option	Pump Type	Maximum Pump Pressure		Maximum Pump Flow		Process Connections	Overall Dimensions	Maximum Ambient Temperature		Refrigerant	Electrical Requirements	Shipping Weight		Model
			psi	bar	gpm	l/min			°F	°C			lb	kg	
1/2	No	Turbine	43.4	3	2.6	9.8	1/2" (F) NPT	L x W x H 23.9 x 10 x 19" 60.7 x 25.4 x 48.3 cm	95°	35°	R404A	120/60/1/12	102	46.3	LS51TX1A110C
1/2	No	Centrifugal	14.5	1.0	3.5	13.2	1/2" (F) NPT	L x W x H 23.9 x 10 x 19" 60.7 x 25.4 x 48.3 cm	95°	35°	R404A	120/60/1/12	102	46.3	LS51MX1A110C
1/2	No	Centrifugal	9	0.62	3.9	14.8	1/2" (F) NPT	L x W x H 23.9 x 10 x 19" 60.7 x 25.4 x 48.3 cm	95°	35°	R404A	120/60/1/12	102	46.3	LS51M1A110C
1/3	No	Centrifugal	14.5	1.0	3.5	13.2	1/2" (F) NPT	L x W x H 20 x 10 x 17" 50.8 x 25.4 x 43.2 cm	95°	35°	R404A	120/60/1/12	75	34.5	LM61MX1A110C
1/3	No	Centrifugal	5.1	0.35	2.1	7.9	1/2" (F) NPT	L x W x H 20 x 10 x 17" 50.8 x 25.4 x 43.2 cm	95°	35°	R404A	120/60/1/12	75	34.5	LM61GX1A110C
1/10	No	Centrifugal	14.5	1.0	3.5	13.2	1/2" (F) NPT	L x W x H 20 x 10 x 17" 50.8 x 25.4 x 43.2 cm	95°	35°	R134a	120/60/1/12	75	34.5	MM71MX1A110C
1/10	No	Centrifugal	5.1	0.35	2.1	7.9	1/2" (F) NPT	L x W x H 20 x 10 x 17" 50.8 x 25.4 x 43.2 cm	95°	35°	R134a	120/60/1/12	75	34.5	MM71GX1A110C
1/4	Yes	Turbine	100	6.90	3.5	13.2	1/2" (F) NPT	L x W x H 27.6 x 14.5 x 22.6" 70.2 x 36.8 x 57.5 cm	95°	35°	R134a	120/60/1/12.2	143	64.8	6260T11A110B
1/3	Yes	Turbine	100	6.90	3.5	13.2	1/2" (F) NPT	L x W x H 27.6 x 14.5 x 22.6" 70.2 x 36.8 x 57.5 cm	95°	35°	R134a	120/60/1/13.1	156	71.0	6360T11A120C
1/2	Yes	Turbine	100	6.90	3.5	13.2	1/2" (F) NPT	L x W x H 27.6 x 14.5 x 22.6" 70.2 x 36.8 x 57.5 cm	95°	35°	R134a	120/60/1/16	181	82.0	6560T11A120C
3/4	Yes	Turbine	100	6.90	3.5	13.2	1/2" (F) NPT	L x W x H 27.6 x 14.5 x 22.6" 70.2 x 36.8 x 57.5 cm	95°	35°	R134a	230/60/1/11.9	197	89.0	6760T21A130D
1	Yes	Turbine	100	6.90	3.5	13.2	1/2" (F) NPT	L x W x H 27.6 x 14.5 x 22.6" 70.2 x 36.8 x 57.5 cm	95°	35°	R134a	230/60/1/12.2	199	90.0	6160T21A130D
1/4	Yes	Positive Displacement	100	6.90	1	3.8	1/2" (F) NPT	L x W x H 27.6 x 14.5 x 22.6" 70.2 x 36.8 x 57.5 cm	95°	35°	R134a	120/60/1/12.2	141	64.0	6260P11A110B
1/3	Yes	Positive Displacement	100	6.90	1	3.8	1/2" (F) NPT	L x W x H 27.6 x 14.5 x 22.6" 70.2 x 36.8 x 57.5 cm	95°	35°	R134a	120/60/1/13.1	153	69.0	6360P11A120C
1/2	Yes	Positive Displacement	100	6.90	1	3.8	1/2" (F) NPT	L x W x H 27.6 x 14.5 x 22.6" 70.2 x 36.8 x 57.5 cm	95°	35°	R134a	120/60/1/16	178	81.0	6560P11A120C
3/4	Yes	Positive Displacement	100	6.90	3.5	13.2	1/2" (F) NPT	L x W x H 27.6 x 14.5 x 22.6" 70.2 x 36.8 x 57.5 cm	95°	35°	R134a	230/60/1/11.9	197	89.0	6760P41A130D
1	Yes	Positive Displacement	100	6.90	3.5	13.2	1/2" (F) NPT	L x W x H 27.6 x 14.5 x 22.6" 70.2 x 36.8 x 57.5 cm	95°	35°	R134a	230/60/1/12.2	199	90.0	6160P41A130D
1/4	Yes	Centrifugal	10	0.69	4.1	15.5	1/2" (F) NPT	L x W x H 27.6 x 14.5 x 22.6" 70.2 x 36.8 x 57.5 cm	95°	35°	R134a	120/60/1/9.5	131	59.4	6260M11A110B
1/3	Yes	Centrifugal	10	0.69	4.1	15.5	1/2" (F) NPT	L x W x H 27.6 x 14.5 x 22.6" 70.2 x 36.8 x 57.5 cm	95°	35°	R134a	120/60/1/10.4	143	64.8	6360M11A110B
1/2	Yes	Centrifugal	10	0.69	4.1	15.5	1/2" (F) NPT	L x W x H 27.6 x 14.5 x 22.6" 70.2 x 36.8 x 57.5 cm	95°	35°	R134a	120/60/1/13.5	168	76.2	6560M11A120C
3/4	Yes	Centrifugal	10	0.69	4.1	15.5	1/2" (F) NPT	L x W x H 27.6 x 14.5 x 22.6" 70.2 x 36.8 x 57.5 cm	95°	35°	R134a	230/60/1/9.2	187	85.0	6760M21A130D
1	Yes	Centrifugal	10	0.69	4.1	15.5	1/2" (F) NPT	L x W x H 27.6 x 14.5 x 22.6" 70.2 x 36.8 x 57.5 cm	95°	35°	R134a	230/60/1/9.5	189	85.7	6160M21A130D
1.5	Yes	Positive Displacement	100	6.90	3.5	13.2	1/2" (F) NPT	L x W x H 30.5 x 19 x 26" 78 x 48 x 66 cm	95°	35°	R134a	460/60/3/5.8	340	154.0	6880 (460V/3PH)
1.5	Yes	Positive Displacement	100	6.90	3.5	13.2	1/2" (F) NPT	L x W x H 30.5 x 19 x 26" 78 x 48 x 66 cm	95°	35°	R134a	240/60/3/11.5	340	154.0	6870 (240V/3PH)
1.5	Yes	Positive Displacement	100	6.90	3.5	13.2	1/2" (F) NPT	L x W x H 30.5 x 19 x 26" 78 x 48 x 66 cm	95°	35°	R134a	230/50-60/3/11.5	340	154.0	6860P46A270D
1.5	Yes	Positive Displacement	100	6.90	3.5	13.2	1/2" (F) NPT	L x W x H 30.5 x 19 x 26" 78 x 48 x 66 cm	95°	35°	R134a	230/60/1/13	340	154.0	6960P46A270D
2	Yes	Centrifugal	20.5	1.41	12	45.1	3/4" (F) NPT	L x W x H 30.5 x 37 x 42" 78 x 94 x 107 cm	95°	35°	R134a	460/60/3/12	520	236.0	DCA200 (460V/3PH)
2	Yes	Centrifugal	20.5	1.41	12	45.1	3/4" (F) NPT	L x W x H 30.5 x 37 x 42" 78 x 94 x 107 cm	95°	35°	R134a	240/60/3/14	520	236.0	DCA200 (240V/3PH)
2	Yes	Centrifugal	20.5	1.41	12	45.1	3/4" (F) NPT	L x W x H 30.5 x 37 x 42" 78 x 94 x 107 cm	95°	35°	R134a	230/60/1/22	520	236.0	DCA200 (230V/1PH)
3	Yes	Centrifugal	20.5	1.41	12	45.1	3/4" (F) NPT	L x W x H 30.5 x 37 x 42" 78 x 94 x 107 cm	95°	35°	R134a	460/60/3/15	570	259.0	DCA300 (460V/3PH)
3	Yes	Centrifugal	20.5	1.41	12	45.1	3/4" (F) NPT	L x W x H 30.5 x 37 x 42" 78 x 94 x 107 cm	95°	35°	R134a	240/60/3/26	570	259.0	DCA300 (240V/3PH)
3	Yes	Centrifugal	20.5	1.41	12	45.1	3/4" (F) NPT	L x W x H 30.5 x 37 x 42" 78 x 94 x 107 cm	95°	35°	R134a	230/60/1/29	570	259.0	DCA300 (230V/1PH)
3	Yes	Centrifugal	20.5	1.41	12	45.1	3/4" (F) NPT	L x W x H 30.5 x 37 x 42" 78 x 94 x 107 cm	95°	35°	R134a	240/60/3/22	570	259.0	DCW300 (240V/3PH)
5	No	Centrifugal	40	2.80	50.2	190	1.5" (F) NPT	L x W x H 56 x 34.5 x 67" 142.2 x 88 x 170.2 cm	104°	40°	R410a	460/60/3/15	990	449.0	DA500 (460V/3PH)
5	No	Centrifugal	40	2.80	50.2	190	1.5" (F) NPT	L x W x H 56 x 34.5 x 67" 142.2 x 88 x 170.2 cm	104°	40°	R410a	240/60/3/27.6	990	449.0	DA500 (240V/3PH)
7.5	No	Centrifugal	40	2.80	50.2	190	1.5" (F) NPT	L x W x H 56 x 34.5 x 67" 142.2 x 88 x 170.2 cm	104°	40°	R410a	460/60/3/20	1,080	490.0	DA750 (460V/3PH)
7.5	No	Centrifugal	40	2.80	50.2	190	1.5" (F) NPT	L x W x H 56 x 34.5 x 67" 142.2 x 88 x 170.2 cm	104°	40°	R410a	575/60/3/25	1,080	490.0	DA750 (575V/3PH)
10	No	Centrifugal	55	3.80	64.7	245	1.5" (F) NPT	L x W x H 77 x 34.5 x 68.2" 195.6 x 88 x 173.2 cm	104°	40°	R410a	460/60/3/30	1,525	692.0	DA1000 (460V/3PH)
10	No	Centrifugal	55	3.80	64.7	245	1.5" (F) NPT	L x W x H 77 x 34.5 x 68.2" 195.6 x 88 x 173.2 cm	104°	40°	R410a	575/60/3/27	1,525	692.0	DA1000 (575V/3PH)

# Technical Specifications

## Refrigerated Circulating Baths, 50 Hz Models

Model	Description	Catalog Page Number	Controller Type	Temperature Range		Temperature Stability		Display Resolution		Reservoir Capacity	Cooling Capacity @ (W)				Heater Wattage	Display/Interface	Pump Type	
				°F	°C	°F	°C	Set	Read		gal/ltr	100°C	20°C	0°C				-20°C
PP07R-20	-20, 7 L Ref. Circulator	34-35	Performance Programmable	-4° to 392°	-20° to 200°	±0.01°	±0.005°	0.01	0.001	1.85/7.0	200	200	120	30	2200	4.3" SmartTouch Touchscreen	Pressure/Suction	
PP07R-40	-40, 7 L Ref. Circulator	34-35	Performance Programmable	-40° to 392°	-40° to 200°	±0.01°	±0.005°	0.01	0.001	1.85/7.0	505	505	375	130	2200	4.3" SmartTouch Touchscreen	Pressure/Suction	
PP7LR-20	-20, 7 L Ref. Circulator	34-35	Performance Programmable	-4° to 392°	-20° to 200°	±0.01°	±0.005°	0.01	0.001	1.85/7.0	200	200	120	30	2200	4.3" SmartTouch Touchscreen	Pressure/Suction	
PP15R-30	-30, 15 L Ref. Circulator	34-35	Performance Programmable	-22° to 392°	-30° to 200°	±0.01°	±0.005°	0.01	0.001	3.96/15.0	915	915	505	165	2200	4.3" SmartTouch Touchscreen	Pressure/Suction	
PP15R-40	-40, 15 L Ref. Circulator	34-35	Performance Programmable	-40° to 392°	-40° to 200°	±0.01°	±0.005°	0.01	0.001	3.96/15.0	1,000	1,000	650	265	2200	4.3" SmartTouch Touchscreen	Pressure/Suction	
PP20R-30	-30, 20 L Ref. Circulator	34-35	Performance Programmable	-22° to 392°	-30° to 200°	±0.01°	±0.005°	0.01	0.001	5.28/20.0	915	915	505	165	2200	4.3" SmartTouch Touchscreen	Pressure/Suction	
PP28R-30	-30, 28 L Ref. Circulator	34-35	Performance Programmable	-22° to 392°	-30° to 200°	±0.01°	±0.005°	0.01	0.001	7.4/28.0	915	915	505	165	2200	4.3" SmartTouch Touchscreen	Pressure/Suction	
PP45R-20	-20, 45 L Ref. Circulator	34-35	Performance Programmable	-13° to 275°	-25° to 135°	±0.01°	±0.005°	0.01	0.001	11.88/45.0	1,400	1,400	800	250	2200	4.3" SmartTouch Touchscreen	Pressure/Suction	
AP07R-20	-20, 7 L Ref. Circulator	36-37	Advanced Programmable	-4° to 392°	-20° to 200°	±0.02°	±0.01°	0.01	0.001	1.85/7.0	200	200	120	30	2200	4.3" SmartTouch Touchscreen	Pressure/Suction	
AP07R-40	-40, 7 L Ref. Circulator	36-37	Advanced Programmable	-40° to 392°	-40° to 200°	±0.02°	±0.01°	0.01	0.001	1.85/7.0	505	505	375	130	2200	4.3" SmartTouch Touchscreen	Pressure/Suction	
AP7LR-20	-20, 7 L Ref. Circulator	36-37	Advanced Programmable	-4° to 392°	-20° to 200°	±0.02°	±0.01°	0.01	0.001	1.85/7.0	200	200	120	30	2200	4.3" SmartTouch Touchscreen	Pressure/Suction	
API5R-30	-30, 15 L Ref. Circulator	36-37	Advanced Programmable	-22° to 392°	-30° to 200°	±0.02°	±0.01°	0.01	0.001	3.96/15.0	915	915	505	165	2200	4.3" SmartTouch Touchscreen	Pressure/Suction	
API5R-40	-40, 15 L Ref. Circulator	36-37	Advanced Programmable	-40° to 392°	-40° to 200°	±0.02°	±0.01°	0.01	0.001	3.96/15.0	1,000	1,000	650	265	2200	4.3" SmartTouch Touchscreen	Pressure/Suction	
AP20R-30	-30, 20 L Ref. Circulator	36-37	Advanced Programmable	-22° to 392°	-30° to 200°	±0.02°	±0.01°	0.01	0.001	5.28/20.0	915	915	505	165	2200	4.3" SmartTouch Touchscreen	Pressure/Suction	
AP28R-30	-30, 28 L Ref. Circulator	36-37	Advanced Programmable	-22° to 392°	-30° to 200°	±0.02°	±0.01°	0.01	0.001	7.4/28.0	915	915	505	165	2200	4.3" SmartTouch Touchscreen	Pressure/Suction	
AP45R-20	-20, 45 L Ref. Circulator	36-37	Advanced Programmable	-13° to 275°	-25° to 135°	±0.02°	±0.01°	0.01	0.001	11.88/45.0	1,400	1,400	800	250	2200	4.3" SmartTouch Touchscreen	Pressure/Suction	
PD07R-20	-20, 7 L Ref. Circulator	38-39	Performance Digital	-4° to 392°	-20° to 200°	±0.01°	±0.005°	0.01	0.001	1.85/7.0	200	200	120	30	2200	4.3" SmartTouch Touchscreen	Pressure/Suction	
PD07R-40	-40, 7 L Ref. Circulator	38-39	Performance Digital	-40° to 392°	-40° to 200°	±0.01°	±0.005°	0.01	0.001	1.85/7.0	505	505	375	130	2200	4.3" SmartTouch Touchscreen	Pressure/Suction	
PD7LR-20	-20, 7 L Ref. Circulator	38-39	Performance Digital	-4° to 392°	-20° to 200°	±0.01°	±0.005°	0.01	0.001	1.85/7.0	200	200	120	30	2200	4.3" SmartTouch Touchscreen	Pressure/Suction	
PDI5R-30	-30, 15 L Ref. Circulator	38-39	Performance Digital	-22° to 392°	-30° to 200°	±0.01°	±0.005°	0.01	0.001	3.96/15.0	915	915	505	165	2200	4.3" SmartTouch Touchscreen	Pressure/Suction	
PDI5R-40	-40, 15 L Ref. Circulator	38-39	Performance Digital	-40° to 392°	-40° to 200°	±0.01°	±0.005°	0.01	0.001	3.96/15.0	1,000	1,000	650	265	2200	4.3" SmartTouch Touchscreen	Pressure/Suction	
PD20R-30	-30, 20 L Ref. Circulator	38-39	Performance Digital	-22° to 392°	-30° to 200°	±0.01°	±0.005°	0.01	0.001	5.28/20.0	915	915	505	165	2200	4.3" SmartTouch Touchscreen	Pressure/Suction	
PD28R-30	-30, 28 L Ref. Circulator	38-39	Performance Digital	-22° to 392°	-30° to 200°	±0.01°	±0.005°	0.01	0.001	7.4/28.0	915	915	505	165	2200	4.3" SmartTouch Touchscreen	Pressure/Suction	
PD45R-20	-20, 45 L Ref. Circulator	38-39	Performance Digital	-13° to 275°	-25° to 135°	±0.01°	±0.005°	0.01	0.001	11.88/45.0	1,400	1,400	800	250	2200	4.3" SmartTouch Touchscreen	Pressure/Suction	
AD07R-20	-20, 7 L Ref. Circulator	40-41	Advanced Digital	-4° to 392°	-20° to 200°	±0.02°	±0.01°	0.01	0.01	1.85/7.0	200	200	120	30	2200	3.75" Touch-Pad LCD	Pressure/Suction	
AD07R-40	-40, 7 L Ref. Circulator	40-41	Advanced Digital	-40° to 392°	-40° to 200°	±0.02°	±0.01°	0.01	0.01	1.85/7.0	505	505	375	130	2200	3.75" Touch-Pad LCD	Pressure/Suction	
AD7LR-20	-20, 7 L Ref. Circulator	40-41	Advanced Digital	-4° to 392°	-20° to 200°	±0.02°	±0.01°	0.01	0.01	1.85/7.0	200	200	120	30	2200	3.75" Touch-Pad LCD	Pressure/Suction	
ADI5R-30	-30, 15 L Ref. Circulator	40-41	Advanced Digital	-22° to 392°	-30° to 200°	±0.02°	±0.01°	0.01	0.01	3.96/15.0	915	915	505	165	2200	3.75" Touch-Pad LCD	Pressure/Suction	
ADI5R-40	-40, 15 L Ref. Circulator	40-41	Advanced Digital	-40° to 392°	-40° to 200°	±0.02°	±0.01°	0.01	0.01	3.96/15.0	1,000	1,000	650	265	2200	3.75" Touch-Pad LCD	Pressure/Suction	
AD20R-30	-30, 20 L Ref. Circulator	40-41	Advanced Digital	-22° to 392°	-30° to 200°	±0.02°	±0.01°	0.01	0.01	5.28/20.0	915	915	505	165	2200	3.75" Touch-Pad LCD	Pressure/Suction	
AD28R-30	-30, 28 L Ref. Circulator	40-41	Advanced Digital	-22° to 392°	-30° to 200°	±0.02°	±0.01°	0.01	0.01	7.4/28.0	915	915	505	165	2200	3.75" Touch-Pad LCD	Pressure/Suction	
AD45R-20	-20, 45 L Ref. Circulator	40-41	Advanced Digital	-13° to 275°	-25° to 135°	±0.02°	±0.01°	0.01	0.01	11.88/45.0	1,400	1,400	800	250	2200	3.75" Touch-Pad LCD	Pressure/Suction	
SD07R-20	-20, 7 L Ref. Circulator	42-43	Standard Digital	-4° to 338°	-20° to 170°	±0.08°	±0.04°	0.1	0.1	1.85/7.0	200	200	120	30	2200	3.75" Touch-Pad LCD	Pressure	
SD7LR-20	-20, 7 L Ref. Circulator	42-43	Standard Digital	-4° to 338°	-20° to 170°	±0.08°	±0.04°	0.1	0.1	1.85/7.0	200	200	120	30	2200	3.75" Touch-Pad LCD	Pressure	
SDI5R-30	-30, 15 L Ref. Circulator	42-43	Standard Digital	-22° to 338°	-30° to 170°	±0.08°	±0.04°	0.1	0.1	3.96/15.0	915	915	505	165	2200	3.75" Touch-Pad LCD	Pressure	

Pump Speeds	Maximum Pressure		Maximum Pressure Flow Rate		Maximum Suction Flow Rate		Process Connections	Working Access	Overall Dimensions	Flammability Class	Over-Temperature Protection/Failsafe Heater Control	Low Level Protection	Reservoir Drain	Maximum Ambient Temperature	Refrigerant	Electrical Requirements		Shipping Weight		Model	
	psi	bar	gpm	l/min	gpm	l/min										L x W x D	L x W x H	VAC/Hz/Ph/A	lb		kg
																		DIN 12876-1	°F		°C
Variable	3.6	0.25	4.4	16.7	3.2	12.2	1/4" (F) NPT	6.18 x 5.59 x 5" 15.7 x 14.2 x 12.7 cm	21.3 x 8.7 x 24.3" 54.1 x 22.1 x 61.7 cm	III (FL)	•	•	•	95°	35°	R134a	240/50/1/12	90	40.8	PP07R-20	
Variable	3.6	0.25	4.4	16.7	3.2	12.2	1/4" (F) NPT	6.18 x 5.59 x 5" 15.7 x 14.2 x 12.7 cm	21.3 x 8.7 x 24.3" 54.1 x 22.1 x 61.7 cm	III (FL)	•	•	•	95°	35°	R404A	240/50/1/12	90	40.8	PP07R-40	
Variable	3.6	0.25	4.4	16.7	3.2	12.2	1/4" (F) NPT	6.18 x 5.59 x 5" 15.7 x 14.2 x 12.7 cm	23.2 x 16.2 x 16.2" 58.9 x 41.1 x 41.1 cm	III (FL)	•	•	•	95°	35°	R134a	240/50/1/12	90	40.8	PP7LR-20	
Variable	3.6	0.25	4.4	16.7	3.2	12.2	1/4" (F) NPT	8.35 x 10.88 x 5.5" 21.2 x 27.6 x 14 cm	22.4 x 14.5 x 26.9" 56.9 x 36.8 x 68.3 cm	III (FL)	•	•	•	95°	35°	R134a	240/50/1/13	118	53.5	PP15R-30	
Variable	3.6	0.25	4.4	16.7	3.2	12.2	1/4" (F) NPT	8.35 x 10.88 x 5.5" 21.2 x 27.6 x 14 cm	22.4 x 14.5 x 26.9" 56.9 x 36.8 x 68.3 cm	III (FL)	•	•	•	95°	35°	R404A	240/50/1/13	118	53.5	PP15R-40	
Variable	3.6	0.25	4.4	16.7	3.2	12.2	1/4" (F) NPT	9.85 x 12.45 x 5.5" 25 x 31.6 x 14 cm	24 x 16.6 x 26.9" 61 x 41.9 x 68.3 cm	III (FL)	•	•	•	95°	35°	R134a	240/50/1/13	130	58.9	PP20R-30	
Variable	3.6	0.25	4.4	16.7	3.2	12.2	1/4" (F) NPT	12.35 x 14.13 x 5.5" 31.4 x 35.9 x 14 cm	26.5 x 18 x 26.9" 67.2 x 45.7 x 68.3 cm	III (FL)	•	•	•	95°	35°	R134a	240/50/1/13	146	66.1	PP28R-30	
Variable	3.6	0.25	4.4	16.7	3.2	12.2	1/4" (F) NPT	21.6 x 15.68 x 5.5" 54.9 x 39.8 x 14 cm	35.8 x 22.4 x 42.1" 90.9 x 56.8 x 107 cm	III (FL)	•	•	•	95°	35°	R134a	208-240/50-60/1/13	180	81.5	PP45R-20	
Variable	3.6	0.25	4.4	16.7	3.2	12.2	1/4" (F) NPT	6.18 x 5.59 x 5" 15.7 x 14.2 x 12.7 cm	21.3 x 8.7 x 24.3" 54.1 x 22.1 x 61.7 cm	III (FL)	•	•	•	95°	35°	R134a	240/50/1/12	90	40.8	AP07R-20	
Variable	3.6	0.25	4.4	16.7	3.2	12.2	1/4" (F) NPT	6.18 x 5.59 x 5" 15.7 x 14.2 x 12.7 cm	21.3 x 8.7 x 24.3" 54.1 x 22.1 x 61.7 cm	III (FL)	•	•	•	95°	35°	R404A	240/50/1/12	90	40.8	AP07R-40	
Variable	3.6	0.25	4.4	16.7	3.2	12.2	1/4" (F) NPT	6.18 x 5.59 x 5" 15.7 x 14.2 x 12.7 cm	23.2 x 16.2 x 16.2" 58.9 x 41.1 x 41.1 cm	III (FL)	•	•	•	95°	35°	R134a	240/50/1/12	90	40.8	AP7LR-20	
Variable	3.6	0.25	4.4	16.7	3.2	12.2	1/4" (F) NPT	8.35 x 10.88 x 5.5" 21.2 x 27.6 x 14 cm	22.4 x 14.5 x 26.9" 56.9 x 36.8 x 68.3 cm	III (FL)	•	•	•	95°	35°	R134a	240/50/1/13	118	53.5	AP15R-30	
Variable	3.6	0.25	4.4	16.7	3.2	12.2	1/4" (F) NPT	8.35 x 10.88 x 5.5" 21.2 x 27.6 x 14 cm	22.4 x 14.5 x 26.9" 56.9 x 36.8 x 68.3 cm	III (FL)	•	•	•	95°	35°	R404A	240/50/1/13	118	53.5	AP15R-40	
Variable	3.6	0.25	4.4	16.7	3.2	12.2	1/4" (F) NPT	9.85 x 12.45 x 5.5" 25 x 31.6 x 14 cm	24 x 16.6 x 26.9" 61 x 41.9 x 68.3 cm	III (FL)	•	•	•	95°	35°	R134a	240/50/1/13	130	58.9	AP20R-30	
Variable	3.6	0.25	4.4	16.7	3.2	12.2	1/4" (F) NPT	12.35 x 14.13 x 5.5" 31.4 x 35.9 x 14 cm	26.5 x 18 x 26.9" 67.2 x 45.7 x 68.3 cm	III (FL)	•	•	•	95°	35°	R134a	240/50/1/13	146	66.1	AP28R-30	
Variable	3.6	0.25	4.4	16.7	3.2	12.2	1/4" (F) NPT	21.6 x 15.68 x 5.5" 54.9 x 39.8 x 14 cm	35.8 x 22.4 x 42.1" 90.9 x 56.8 x 107 cm	III (FL)	•	•	•	95°	35°	R134a	208-240/50-60/1/13	180	81.5	AP45R-20	
Variable	3.6	0.25	4.4	16.7	3.2	12.2	1/4" (F) NPT	6.18 x 5.59 x 5" 15.7 x 14.2 x 12.7 cm	21.3 x 8.7 x 24.3" 54.1 x 22.1 x 61.7 cm	III (FL)	•	•	•	95°	35°	R134a	240/50/1/12	90	40.8	PD07R-20	
Variable	3.6	0.25	4.4	16.7	3.2	12.2	1/4" (F) NPT	6.18 x 5.59 x 5" 15.7 x 14.2 x 12.7 cm	21.3 x 8.7 x 24.3" 54.1 x 22.1 x 61.7 cm	III (FL)	•	•	•	95°	35°	R404A	240/50/1/12	90	40.8	PD07R-40	
Variable	3.6	0.25	4.4	16.7	3.2	12.2	1/4" (F) NPT	6.18 x 5.59 x 5" 15.7 x 14.2 x 12.7 cm	23.2 x 16.2 x 16.2" 58.9 x 41.1 x 41.1 cm	III (FL)	•	•	•	95°	35°	R134a	240/50/1/12	90	40.8	PD7LR-20	
Variable	3.6	0.25	4.4	16.7	3.2	12.2	1/4" (F) NPT	8.35 x 10.88 x 5.5" 21.2 x 27.6 x 14 cm	22.4 x 14.5 x 26.9" 56.9 x 36.8 x 68.3 cm	III (FL)	•	•	•	95°	35°	R134a	240/50/1/13	118	53.5	PD15R-30	
Variable	3.6	0.25	4.4	16.7	3.2	12.2	1/4" (F) NPT	8.35 x 10.88 x 5.5" 21.2 x 27.6 x 14 cm	22.4 x 14.5 x 26.9" 56.9 x 36.8 x 68.3 cm	III (FL)	•	•	•	95°	35°	R404A	240/50/1/13	118	53.5	PD15R-40	
Variable	3.6	0.25	4.4	16.7	3.2	12.2	1/4" (F) NPT	9.85 x 12.45 x 5.5" 25 x 31.6 x 14 cm	24 x 16.6 x 26.9" 61 x 41.9 x 68.3 cm	III (FL)	•	•	•	95°	35°	R134a	240/50/1/13	130	58.9	PD20R-30	
Variable	3.6	0.25	4.4	16.7	3.2	12.2	1/4" (F) NPT	12.35 x 14.13 x 5.5" 31.4 x 35.9 x 14 cm	26.5 x 18 x 26.9" 67.2 x 45.7 x 68.3 cm	III (FL)	•	•	•	95°	35°	R134a	240/50/1/13	146	66.1	PD28R-30	
Variable	3.6	0.25	4.4	16.7	3.2	12.2	1/4" (F) NPT	21.6 x 15.68 x 5.5" 54.9 x 39.8 x 14 cm	35.8 x 22.4 x 42.1" 90.9 x 56.8 x 107 cm	III (FL)	•	•	•	95°	35°	R134a	208-240/50-60/1/13	180	81.5	PD45R-20	
Variable	3.6	0.25	4.4	16.7	3.2	12.2	1/4" (F) NPT	6.18 x 5.59 x 5" 15.7 x 14.2 x 12.7 cm	21.3 x 8.7 x 24.3" 54.1 x 22.1 x 61.7 cm	III (FL)	•	•	•	95°	35°	R134a	240/50/1/12	90	40.8	AD07R-20	
Variable	3.6	0.25	4.4	16.7	3.2	12.2	1/4" (F) NPT	6.18 x 5.59 x 5" 15.7 x 14.2 x 12.7 cm	21.3 x 8.7 x 24.3" 54.1 x 22.1 x 61.7 cm	III (FL)	•	•	•	95°	35°	R404A	240/50/1/12	90	40.8	AD07R-40	
Variable	3.6	0.25	4.4	16.7	3.2	12.2	1/4" (F) NPT	6.18 x 5.59 x 5" 15.7 x 14.2 x 12.7 cm	23.2 x 16.2 x 16.2" 58.9 x 41.1 x 41.1 cm	III (FL)	•	•	•	95°	35°	R134a	240/50/1/12	90	40.8	AD7LR-20	
Variable	3.6	0.25	4.4	16.7	3.2	12.2	1/4" (F) NPT	8.35 x 10.88 x 5.5" 21.2 x 27.6 x 14 cm	22.4 x 14.5 x 26.9" 56.9 x 36.8 x 68.3 cm	III (FL)	•	•	•	95°	35°	R134a	240/50/1/13	118	53.5	AD15R-30	
Variable	3.6	0.25	4.4	16.7	3.2	12.2	1/4" (F) NPT	8.35 x 10.88 x 5.5" 21.2 x 27.6 x 14 cm	22.4 x 14.5 x 26.9" 56.9 x 36.8 x 68.3 cm	III (FL)	•	•	•	95°	35°	R404A	240/50/1/13	118	53.5	AD15R-40	
Variable	3.6	0.25	4.4	16.7	3.2	12.2	1/4" (F) NPT	9.85 x 12.45 x 5.5" 25 x 31.6 x 14 cm	24 x 16.6 x 26.9" 61 x 41.9 x 68.3 cm	III (FL)	•	•	•	95°	35°	R134a	240/50/1/13	130	58.9	AD20R-30	
Variable	3.6	0.25	4.4	16.7	3.2	12.2	1/4" (F) NPT	12.35 x 14.13 x 5.5" 31.4 x 35.9 x 14 cm	26.5 x 18 x 26.9" 67.2 x 45.7 x 68.3 cm	III (FL)	•	•	•	95°	35°	R134a	240/50/1/13	146	66.1	AD28R-30	
Variable	3.6	0.25	4.4	16.7	3.2	12.2	1/4" (F) NPT	21.6 x 15.68 x 5.5" 54.9 x 39.8 x 14 cm	35.8 x 22.4 x 42.1" 90.9 x 56.8 x 107 cm	III (FL)	•	•	•	95°	35°	R134a	208-240/50-60/1/13	180	81.5	AD45R-20	
Two	2.9	0.20	2.7	10.2			1/4" (F) NPT	6.18 x 5.59 x 5" 15.7 x 14.2 x 12.7 cm	21.3 x 8.7 x 24.3" 54.1 x 22.1 x 61.7 cm	I (NFL)	•	•	•	95°	35°	R134a	240/50/1/12	90	40.8	SD07R-20	
Two	2.9	0.20	2.7	10.2			1/4" (F) NPT	6.18 x 5.59 x 5" 15.7 x 14.2 x 12.7 cm	23.2 x 16.2 x 16.2" 58.9 x 41.1 x 41.1 cm	I (NFL)	•	•	•	95°	35°	R134a	240/50/1/12	90	40.8	SD7LR-20	
Two	2.9	0.20	2.7	10.2			1/4" (F) NPT	8.35 x 10.88 x 5.5" 21.2 x 27.6 x 14 cm	22.4 x 14.5 x 26.9" 56.9 x 36.8 x 68.3 cm	I (NFL)	•	•	•	95°	35°	R134a	240/50/1/13	118	53.5	SD15R-30	

# Technical Specifications

## Refrigerated Circulating Baths, 50 Hz Models

Model	Description	Catalog Page Number	Controller Type	Temperature Range		Temperature Stability		Display Resolution		Reservoir Capacity	Cooling Capacity @ (W)				Heater Wattage	Display/Interface	Pump Type	
				°F	°C	°F	°C	Set	Read		gal/ltr	100°C	20°C	0°C				-20°C
				SD20R-30	-30, 20 L Ref. Circulator	42-43	Standard Digital	-22° to 338°	-30° to 170°		±0.08°	±0.04°	0.1	0.1				5.28/20.0
SD28R-30	-30, 28 L Ref. Circulator	42-43	Standard Digital	-22° to 338°	-30° to 170°	±0.08°	±0.04°	0.1	0.1	7.4/28.0	915	915	505	165	2200	3.75" Touch-Pad LCD	Pressure	
MX07R-20	-20, 7 L Ref. Circulator	44-45	MX	-4° to 275°	-20° to 135°	±0.13°	±0.07°	0.1	0.1	1.85/7.0	200	200	120	30	1100	3.25" LCD	Pressure	
MX7LR-20	-20, 7 L Ref. Circulator	44-45	MX	-4° to 275°	-20° to 135°	±0.13°	±0.07°	0.1	0.1	1.85/7.0	200	200	120	30	1100	3.25" LCD	Pressure	
MX15R-30	-30, 15 L Ref. Circulator	44-45	MX	-22° to 275°	-30° to 135°	±0.13°	±0.07°	0.1	0.1	3.96/15.0	915	915	505	165	1100	3.25" LCD	Pressure	
MX20R-30	-30, 20 L Ref. Circulator	44-45	MX	-22° to 275°	-30° to 135°	±0.13°	±0.07°	0.1	0.1	5.28/20.0	915	915	505	165	1100	3.25" LCD	Pressure	

## Heated Circulating Baths, 50 Hz Models

Model	Description	Catalog Page Number	Controller Type	Temperature Range		Temperature Stability		Display Resolution		Reservoir Capacity	Tank Material	Heater Wattage	Display/Interface	Pump Type	
				°F	°C	°F	°C	Set	Read						gal/ltr
				PP07H200	200, 7 L Htg. Circulator	50-51	Performance Programmable	Ambient + 20° to 392°	Ambient +10° to 200°						±0.01°
PPI5H200	200, 15 L Htg. Circulator	50-51	Performance Programmable	Ambient + 20° to 392°	Ambient +10° to 200°	±0.01°	±0.005°	0.01	0.001	3.96/15	Stainless Steel	2200	4.3" SmartTouch Touchscreen	Pressure/Suction	
PP20H200	200, 20 L Htg. Circulator	50-51	Performance Programmable	Ambient + 20° to 392°	Ambient +10° to 200°	±0.01°	±0.005°	0.01	0.001	5.28/20	Stainless Steel	2200	4.3" SmartTouch Touchscreen	Pressure/Suction	
PP28H200	200, 28 L Htg. Circulator	50-51	Performance Programmable	Ambient + 20° to 392°	Ambient +10° to 200°	±0.01°	±0.005°	0.01	0.001	7.4/28	Stainless Steel	2200	4.3" SmartTouch Touchscreen	Pressure/Suction	
AP07H200	200, 7 L Htg. Circulator	52-53	Advanced Programmable	Ambient + 20° to 392°	Ambient +10° to 200°	±0.02°	±0.01°	0.01	0.001	1.85/7	Stainless Steel	2200	4.3" SmartTouch Touchscreen	Pressure/Suction	
API5H200	200, 15 L Htg. Circulator	52-53	Advanced Programmable	Ambient + 20° to 392°	Ambient +10° to 200°	±0.02°	±0.01°	0.01	0.001	3.96/15	Stainless Steel	2200	4.3" SmartTouch Touchscreen	Pressure/Suction	
AP20H200	200, 20 L Htg. Circulator	52-53	Advanced Programmable	Ambient + 20° to 392°	Ambient +10° to 200°	±0.02°	±0.01°	0.01	0.001	5.28/20	Stainless Steel	2200	4.3" SmartTouch Touchscreen	Pressure/Suction	
AP28H200	200, 28 L Htg. Circulator	52-53	Advanced Programmable	Ambient + 20° to 392°	Ambient +10° to 200°	±0.02°	±0.01°	0.01	0.001	7.4/28	Stainless Steel	2200	4.3" SmartTouch Touchscreen	Pressure/Suction	
PD07H200	200, 7 L Htg. Circulator	54-55	Performance Digital	Ambient + 20° to 392°	Ambient +10° to 200°	±0.01°	±0.005°	0.01	0.001	1.85/7	Stainless Steel	2200	4.3" SmartTouch Touchscreen	Pressure/Suction	
PDI5H200	200, 15 L Htg. Circulator	54-55	Performance Digital	Ambient + 20° to 392°	Ambient +10° to 200°	±0.01°	±0.005°	0.01	0.001	3.96/15	Stainless Steel	2200	4.3" SmartTouch Touchscreen	Pressure/Suction	
PD20H200	200, 20 L Htg. Circulator	54-55	Performance Digital	Ambient + 20° to 392°	Ambient +10° to 200°	±0.01°	±0.005°	0.01	0.001	5.28/20	Stainless Steel	2200	4.3" SmartTouch Touchscreen	Pressure/Suction	
PD28H200	200, 28 L Htg. Circulator	54-55	Performance Digital	Ambient + 20° to 392°	Ambient +10° to 200°	±0.01°	±0.005°	0.01	0.001	7.4/28	Stainless Steel	2200	4.3" SmartTouch Touchscreen	Pressure/Suction	
AD07H200	200, 7 L Htg. Circulator	56-57	Advanced Digital	Ambient + 20° to 392°	Ambient +10° to 200°	±0.02°	±0.01°	0.01	0.01	1.85/7	Stainless Steel	2200	3.75" Touch-Pad LCD	Pressure/Suction	
ADI5H200	200, 15 L Htg. Circulator	56-57	Advanced Digital	Ambient + 20° to 392°	Ambient +10° to 200°	±0.02°	±0.01°	0.01	0.01	3.96/15	Stainless Steel	2200	3.75" Touch-Pad LCD	Pressure/Suction	
AD20H200	200, 20 L Htg. Circulator	56-57	Advanced Digital	Ambient + 20° to 392°	Ambient +10° to 200°	±0.02°	±0.01°	0.01	0.01	5.28/20	Stainless Steel	2200	3.75" Touch-Pad LCD	Pressure/Suction	
AD28H200	200, 28 L Htg. Circulator	56-57	Advanced Digital	Ambient + 20° to 392°	Ambient +10° to 200°	±0.02°	±0.01°	0.01	0.01	7.4/28	Stainless Steel	2200	3.75" Touch-Pad LCD	Pressure/Suction	
SD07H170	170, 7 L Htg. Circulator	58-59	Standard Digital	Ambient + 20° to 338°	Ambient +10° to 170°	±0.08°	±0.04°	0.1	0.1	1.85/7	Stainless Steel	2200	3.75" Touch-Pad LCD	Pressure	
SD15H170	170, 15 L Htg. Circulator	58-59	Standard Digital	Ambient + 20° to 338°	Ambient +10° to 170°	±0.08°	±0.04°	0.1	0.1	3.96/15	Stainless Steel	2200	3.75" Touch-Pad LCD	Pressure	
SD20H170	170, 20 L Htg. Circulator	58-59	Standard Digital	Ambient + 20° to 338°	Ambient +10° to 170°	±0.08°	±0.04°	0.1	0.1	5.28/20	Stainless Steel	2200	3.75" Touch-Pad LCD	Pressure	
SD28H170	170, 28 L Htg. Circulator	58-59	Standard Digital	Ambient + 20° to 338°	Ambient +10° to 170°	±0.08°	±0.04°	0.1	0.1	7.4/28	Stainless Steel	2200	3.75" Touch-Pad LCD	Pressure	
MX07H135	135, 7 L Htg. Circulator	60-61	MX	Ambient + 20° to 275°	Ambient +10° to 135°	±0.13°	±0.07°	0.1	0.1	1.85/7	Stainless Steel	1100	3.25" LCD	Pressure	
MX15H135	135, 15 L Htg. Circulator	60-61	MX	Ambient + 20° to 275°	Ambient +10° to 135°	±0.13°	±0.07°	0.1	0.1	3.96/15	Stainless Steel	1100	3.25" LCD	Pressure	
MX20H135	135, 20 L Htg. Circulator	60-61	MX	Ambient + 20° to 275°	Ambient +10° to 135°	±0.13°	±0.07°	0.1	0.1	5.28/20	Stainless Steel	1100	3.25" LCD	Pressure	
MX-CA	135, Immersion Circulator	66	MX Immersion	Ambient + 20° to 275°	Ambient +10° to 135°	±0.13°	±0.07°	0.1	0.1	7.4/28 max		1100	3.25" LCD	Pressure	



Pump Speeds	Maximum Pressure		Maximum Pressure Flow Rate		Maximum Suction Flow Rate		Process Connections	Working Access	Overall Dimensions	Flammability Class	Over-Temperature Protection/Failsafe Heater Control	Low Level Protection	Reservoir Drain	Maximum Ambient Temperature	Refrigerant	Electrical Requirements		Shipping Weight		Model
	psi	bar	gpm	l/min	gpm	l/min										L x W x D	L x W x H	DIN 12876-1	°F	
Two	2.9	0.20	2.7	10.2			1/4" (F) NPT	9.85 x 12.45 x 5.5" 25 x 31.6 x 14 cm	24 x 16.6 x 26.9" 61 x 41.9 x 68.3 cm	I (NFL)	•	•	•	95°	35°	R134a	240/50/1/13	130	58.9	SD20R-30
Two	2.9	0.20	2.7	10.2			1/4" (F) NPT	12.35 x 14.13 x 5.5" 31.4 x 35.9 x 14 cm	26.5 x 18 x 26.9" 67.2 x 45.7 x 68.3 cm	I (NFL)	•	•	•	95°	35°	R134a	240/50/1/13	146	66.1	SD28R-30
One	1.5	0.10	2.8	10.6			1/2" O.D. Barbed Tubes	6.18 x 5.59 x 5" 15.7 x 14.2 x 12.7 cm	21.3 x 8.7 x 25.4" 54.1 x 22.1 x 64.5 cm	I (NFL)	•	•	•	95°	35°	R134a	240/50/1/8	84	38.1	MX07R-20
One	1.5	0.10	2.8	10.6			1/2" O.D. Barbed Tubes	6.18 x 5.59 x 5" 15.7 x 14.2 x 12.7 cm	23.2 x 16.2 x 17.3" 58.9 x 41.1 x 43.9 cm	I (NFL)	•	•	•	95°	35°	R134a	240/50/1/8	84	38.1	MX7LR-20
One	1.5	0.10	2.8	10.6			1/2" O.D. Barbed Tubes	8.35 x 10.88 x 5.5" 21.2 x 27.6 x 14 cm	22.4 x 14.5 x 28" 56.9 x 36.8 x 71.1 cm	I (NFL)	•	•	•	95°	35°	R134a	240/50/1/10	112	50.7	MX15R-30
One	1.5	0.10	2.8	10.6			1/2" O.D. Barbed Tubes	9.85 x 12.45 x 5.5" 25 x 31.6 x 14 cm	24 x 16.5 x 28" 61 x 41.9 x 71.1 cm	I (NFL)	•	•	•	95°	35°	R134a	240/50/1/10	124	56.2	MX20R-30

Pump Speeds	Maximum Pressure		Maximum Pressure Flow Rate		Maximum Suction Flow Rate		Process Connections	Working Access	Overall Dimensions	Flammability Class	Over-Temperature Protection/Failsafe Heater Control	Low Level Protection	Reservoir Drain	Cooling Coil	Maximum Ambient Temperature	Electrical Requirements	Shipping Weight		Model	
	psi	bar	gpm	l/min	gpm	l/min											L x W x D	L x W x H		DIN 12876-1
Variable	3.6	0.25	4.4	16.7	3.2	12.2	1/4" (F) NPT	6.18 x 5.59 x 5" 15.7 x 14.2 x 12.7 cm	19.6 x 8.7 x 16.1" 49.9 x 22.1 x 40.9 cm	III (FL)	•	•	•	•	95°	35°	240/50/1/10	45	20.4	PP07H200
Variable	3.6	0.25	4.4	16.7	3.2	12.2	1/4" (F) NPT	8.35 x 10.88 x 5.5" 21.2 x 27.6 x 14 cm	22.4 x 14.5 x 16.6" 56.9 x 36.8 x 42.2 cm	III (FL)	•	•	•	•	95°	35°	240/50/1/10	62	28.1	PP15H200
Variable	3.6	0.25	4.4	16.7	3.2	12.2	1/4" (F) NPT	9.85 x 12.45 x 5.5" 25 x 31.6 x 14 cm	24 x 16.5 x 16.6" 61 x 41.9 x 42.2 cm	III (FL)	•	•	•	•	95°	35°	240/50/1/10	70	31.7	PP20H200
Variable	3.6	0.25	4.4	16.7	3.2	12.2	1/4" (F) NPT	12.35 x 14.13 x 5.5" 31.4 x 35.9 x 14 cm	26.5 x 18 x 16.6" 67.2 x 45.7 x 42.2 cm	III (FL)	•	•	•	•	95°	35°	240/50/1/10	82	37.1	PP28H200
Variable	3.6	0.25	4.4	16.7	3.2	12.2	1/4" (F) NPT	6.18 x 5.59 x 5" 15.7 x 14.2 x 12.7 cm	19.6 x 8.7 x 16.1" 49.9 x 22.1 x 40.9 cm	III (FL)	•	•	•	•	95°	35°	240/50/1/10	42	19.0	AP07H200
Variable	3.6	0.25	4.4	16.7	3.2	12.2	1/4" (F) NPT	8.35 x 10.88 x 5.5" 21.2 x 27.6 x 14 cm	22.4 x 14.5 x 16.6" 56.9 x 36.8 x 42.2 cm	III (FL)	•	•	•	•	95°	35°	240/50/1/10	62	28.1	AP15H200
Variable	3.6	0.25	4.4	16.7	3.2	12.2	1/4" (F) NPT	9.85 x 12.45 x 5.5" 25 x 31.6 x 14 cm	24 x 16.5 x 16.6" 61 x 41.9 x 42.2 cm	III (FL)	•	•	•	•	95°	35°	240/50/1/10	70	31.7	AP20H200
Variable	3.6	0.25	4.4	16.7	3.2	12.2	1/4" (F) NPT	12.35 x 14.13 x 5.5" 31.4 x 35.9 x 14 cm	26.5 x 18 x 16.6" 67.2 x 45.7 x 42.2 cm	III (FL)	•	•	•	•	95°	35°	240/50/1/10	82	37.1	AP28H200
Variable	3.6	0.25	4.4	16.7	3.2	12.2	1/4" (F) NPT	6.18 x 5.59 x 5" 15.7 x 14.2 x 12.7 cm	19.6 x 8.7 x 16.1" 49.9 x 22.1 x 40.9 cm	III (FL)	•	•	•	•	95°	35°	240/50/1/10	42	19.0	AD07H200
Variable	3.6	0.25	4.4	16.7	3.2	12.2	1/4" (F) NPT	8.35 x 10.88 x 5.5" 21.2 x 27.6 x 14 cm	22.4 x 14.5 x 16.6" 56.9 x 36.8 x 42.2 cm	III (FL)	•	•	•	•	95°	35°	240/50/1/10	62	28.1	AD15H200
Variable	3.6	0.25	4.4	16.7	3.2	12.2	1/4" (F) NPT	9.85 x 12.45 x 5.5" 25 x 31.6 x 14 cm	24 x 16.5 x 16.6" 61 x 41.9 x 42.2 cm	III (FL)	•	•	•	•	95°	35°	240/50/1/10	70	31.7	AD20H200
Variable	3.6	0.25	4.4	16.7	3.2	12.2	1/4" (F) NPT	12.35 x 14.13 x 5.5" 31.4 x 35.9 x 14 cm	26.5 x 18 x 16.6" 67.2 x 45.7 x 42.2 cm	III (FL)	•	•	•	•	95°	35°	240/50/1/10	82	37.1	AD28H200
Two	2.9	0.2	2.7	10.2			1/4" (F) NPT	6.18 x 5.59 x 5" 15.7 x 14.2 x 12.7 cm	19.6 x 8.7 x 16.1" 49.9 x 22.1 x 40.9 cm	I (NFL)	•	•	•	•	95°	35°	240/50/1/10	42	19.0	SD07H170
Two	2.9	0.2	2.7	10.2			1/4" (F) NPT	8.35 x 10.88 x 5.5" 21.2 x 27.6 x 14 cm	22.4 x 14.5 x 16.6" 56.9 x 36.8 x 42.2 cm	I (NFL)	•	•	•	•	95°	35°	240/50/1/10	62	28.1	SD15H170
Two	2.9	0.2	2.7	10.2			1/4" (F) NPT	9.85 x 12.45 x 5.5" 25 x 31.6 x 14 cm	24 x 16.5 x 16.6" 61 x 41.9 x 42.2 cm	I (NFL)	•	•	•	•	95°	35°	240/50/1/10	70	31.7	SD20H170
Two	2.9	0.2	2.7	10.2			1/4" (F) NPT	12.35 x 14.13 x 5.5" 31.4 x 35.9 x 14 cm	26.5 x 18 x 16.6" 67.2 x 45.7 x 42.2 cm	I (NFL)	•	•	•	•	95°	35°	240/50/1/10	82	37.1	SD28H170
One	1.5	0.1	2.8	10.6			1/2" O.D. Barbed Tubes	6.18 x 5.59 x 5" 15.7 x 14.2 x 12.7 cm	19.6 x 8.7 x 17.2" 49.9 x 22.1 x 43.7 cm	I (NFL)	•	•	•	•	95°	35°	240/50/1/6	36	16.3	MX07H135
One	1.5	0.1	2.8	10.6			1/2" O.D. Barbed Tubes	8.35 x 10.88 x 5.5" 21.2 x 27.6 x 14 cm	22.4 x 14.5 x 17.8" 56.9 x 36.8 x 45.2 cm	I (NFL)	•	•	•	•	95°	35°	240/50/1/6	56	25.4	MX15H135
One	1.5	0.1	2.8	10.6			1/2" O.D. Barbed Tubes	9.85 x 12.45 x 5.5" 25 x 31.6 x 14 cm	24 x 16.5 x 17.8" 61 x 41.9 x 45.2 cm	I (NFL)	•	•	•	•	95°	35°	240/50/1/6	64	29.0	MX20H135
One	1.5	0.1	2.8	10.6				4.3 x 3.8 x 14.1" 10.9 x 9.7 x 35.8 cm		I (NFL)	•	•	•	•	95°	35°	240/50/1/6	10	4.5	MX-CA

# Technical Specifications

## Open Bath Systems, 50 Hz Models

Model	Description	Catalog Page Number	Controller Type	Temperature Range		Temperature Stability		Display Resolution		Reservoir Capacity gal/ltr	Tank Material	Heater Wattage	Display/Interface	Pump Type
				°F	°C	°F	°C	Set	Read					
AP06S150	6 L Open Bath System	62-63	Advanced Programmable	Ambient +20° to 302°	Ambient +10° to 150°	±0.02°	±0.01°	0.01	0.001	1.58/6	Stainless Steel	2200	4.3" SmartTouch Touchscreen	Pressure/Suction
API0S150	10 L Open Bath System	62-63	Advanced Programmable	Ambient +20° to 302°	Ambient +10° to 150°	±0.02°	±0.01°	0.01	0.001	2.64/10	Stainless Steel	2200	4.3" SmartTouch Touchscreen	Pressure/Suction
AP20S150	20 L Open Bath System	62-63	Advanced Programmable	Ambient +20° to 302°	Ambient +10° to 150°	±0.02°	±0.01°	0.01	0.001	5.28/20	Stainless Steel	2200	4.3" SmartTouch Touchscreen	Pressure/Suction
AP28S150	28 L Open Bath System	62-63	Advanced Programmable	Ambient +20° to 302°	Ambient +10° to 150°	±0.02°	±0.01°	0.01	0.001	7.40/28	Stainless Steel	2200	4.3" SmartTouch Touchscreen	Pressure/Suction
AD06S150	6 L Open Bath System	62-63	Advanced Digital	Ambient +20° to 302°	Ambient +10° to 150°	±0.02°	±0.01°	0.01	0.01	1.58/6	Stainless Steel	2200	3.75" Touch-Pad LCD	Pressure/Suction
AD10S150	10 L Open Bath System	62-63	Advanced Digital	Ambient +20° to 302°	Ambient +10° to 150°	±0.02°	±0.01°	0.01	0.01	2.64/10	Stainless Steel	2200	3.75" Touch-Pad LCD	Pressure/Suction
AD20S150	20 L Open Bath System	62-63	Advanced Digital	Ambient +20° to 302°	Ambient +10° to 150°	±0.02°	±0.01°	0.01	0.01	5.28/20	Stainless Steel	2200	3.75" Touch-Pad LCD	Pressure/Suction
AD28S150	28 L Open Bath System	62-63	Advanced Digital	Ambient +20° to 302°	Ambient +10° to 150°	±0.02°	±0.01°	0.01	0.01	7.40/28	Stainless Steel	2200	3.75" Touch-Pad LCD	Pressure/Suction
MX06S135	6 L Open Bath System	62-63	MX	Ambient +20° to 275°	Ambient +10° to 135°	±0.13°	±0.07°	0.1	0.1	1.58/6	Stainless Steel	1100	3.25" LCD	Pressure
MX10S135	10 L Open Bath System	62-63	MX	Ambient +20° to 275°	Ambient +10° to 135°	±0.13°	±0.07°	0.1	0.1	2.64/10	Stainless Steel	1100	3.25" LCD	Pressure
MX20S135	20 L Open Bath System	62-63	MX	Ambient +20° to 275°	Ambient +10° to 135°	±0.13°	±0.07°	0.1	0.1	5.28/20	Stainless Steel	1100	3.25" LCD	Pressure
MX28S135	28 L Open Bath System	62-63	MX	Ambient +20° to 275°	Ambient +10° to 135°	±0.13°	±0.07°	0.1	0.1	7.40/28	Stainless Steel	1100	3.25" LCD	Pressure
AP08P100	8 L Open Bath System	64-65	Advanced Programmable	Ambient +20° to 185°	Ambient +10° to 85°	±0.02°	±0.01°	0.01	0.001	2.11/8	Polycarbonate	2200	4.3" SmartTouch Touchscreen	Pressure/Suction
API1P100	11 L Open Bath System	64-65	Advanced Programmable	Ambient +20° to 185°	Ambient +10° to 85°	±0.02°	±0.01°	0.01	0.001	2.91/11	Polycarbonate	2200	4.3" SmartTouch Touchscreen	Pressure/Suction
API4P100	14 L Open Bath System	64-65	Advanced Programmable	Ambient +20° to 185°	Ambient +10° to 85°	±0.02°	±0.01°	0.01	0.001	3.70/14	Polycarbonate	2200	4.3" SmartTouch Touchscreen	Pressure/Suction
API7P100	17 L Open Bath System	64-65	Advanced Programmable	Ambient +20° to 185°	Ambient +10° to 85°	±0.02°	±0.01°	0.01	0.001	4.49/17	Polycarbonate	2200	4.3" SmartTouch Touchscreen	Pressure/Suction
AP23P100	23 L Open Bath System	64-65	Advanced Programmable	Ambient +20° to 185°	Ambient +10° to 85°	±0.02°	±0.01°	0.01	0.001	6.08/23	Polycarbonate	2200	4.3" SmartTouch Touchscreen	Pressure/Suction
AP28P100	28 L Open Bath System	64-65	Advanced Programmable	Ambient +20° to 185°	Ambient +10° to 85°	±0.02°	±0.01°	0.01	0.001	7.40/28	Polycarbonate	2200	4.3" SmartTouch Touchscreen	Pressure/Suction
MX08P100	8 L Open Bath System	64-65	MX	Ambient +20° to 185°	Ambient +10° to 85°	±0.13°	±0.07°	0.1	0.1	2.11/8	Polycarbonate	1100	3.25" LCD	Pressure
MX11P100	11 L Open Bath System	64-65	MX	Ambient +20° to 185°	Ambient +10° to 85°	±0.13°	±0.07°	0.1	0.1	2.91/11	Polycarbonate	1100	3.25" LCD	Pressure
MX14P100	14 L Open Bath System	64-65	MX	Ambient +20° to 185°	Ambient +10° to 85°	±0.13°	±0.07°	0.1	0.1	3.70/14	Polycarbonate	1100	3.25" LCD	Pressure
MX17P100	17 L Open Bath System	64-65	MX	Ambient +20° to 185°	Ambient +10° to 85°	±0.13°	±0.07°	0.1	0.1	4.49/17	Polycarbonate	1100	3.25" LCD	Pressure
MX23P100	23 L Open Bath System	64-65	MX	Ambient +20° to 185°	Ambient +10° to 85°	±0.13°	±0.07°	0.1	0.1	6.08/23	Polycarbonate	1100	3.25" LCD	Pressure
MX28P100	28 L Open Bath System	64-65	MX	Ambient +20° to 185°	Ambient +10° to 85°	±0.13°	±0.07°	0.1	0.1	7.40/28	Polycarbonate	1100	3.25" LCD	Pressure

Pump Speeds	Maximum Pressure		Maximum Pressure Flow Rate		Maximum Suction Flow Rate		Process Connections	Working Access	Overall Dimensions	Flammability Class	Over-Temperature Protection/Failsafe Heater Control	Low Level Protection	Reservoir Drain	Cooling Coil	Maximum Ambient Temperature		Electrical Requirements	Shipping Weight		Model
	psi	bar	gpm	l/min	gpm	l/min									L x W x D	L x W x H		°F	°C	
Variable	3.6	0.25	4.4	16.7	3.2	12.2	1/4" (F) NPT	3.9 x 4.3 x 6" 10 x 11 x 15.2 cm	13.4 x 8.1 x 14.9" 34 x 20.6 x 37.8 cm	I (NFL)	•	•			95°	35°	240/50/1/10	26	11.8	AP06S150
Variable	3.6	0.25	4.4	16.7	3.2	12.2	1/4" (F) NPT	3.9 x 10.1 x 6" 9.9 x 25.5 x 15.2 cm	13.9 x 13.5 x 14.9" 35.3 x 34.2 x 37.8 cm	I (NFL)	•	•	Acc		95°	35°	240/50/1/10	45	20.4	API0S150
Variable	3.6	0.25	4.4	16.7	3.2	12.2	1/4" (F) NPT	10.4 x 9 x 6" 26.4 x 22.8 x 15.2 cm	20.9 x 13.5 x 14.9" 53.1 x 34.2 x 37.8 cm	I (NFL)	•	•	Acc		95°	35°	240/50/1/10	60	27.2	AP20S150
Variable	3.6	0.25	4.4	16.7	3.2	12.2	1/4" (F) NPT	10.1 x 8.4 x 8" 25.7 x 21.4 x 20.3 cm	20.9 x 13.5 x 16.9" 53.1 x 34.2 x 42.9 cm	I (NFL)	•	•	Acc		95°	35°	240/50/1/10	72	32.6	AP28S150
Variable	3.6	0.25	4.4	16.7	3.2	12.2	1/4" (F) NPT	3.9 x 4.3 x 6" 10 x 11 x 15.2 cm	13.4 x 8.1 x 14.9" 34 x 20.6 x 37.8 cm	I (NFL)	•	•			95°	35°	240/50/1/10	26	11.8	AD06S150
Variable	3.6	0.25	4.4	16.7	3.2	12.2	1/4" (F) NPT	3.9 x 10.1 x 6" 9.9 x 25.5 x 15.2 cm	13.9 x 13.5 x 14.9" 35.3 x 34.2 x 37.8 cm	I (NFL)	•	•	Acc		95°	35°	240/50/1/10	45	20.4	AD10S150
Variable	3.6	0.25	4.4	16.7	3.2	12.2	1/4" (F) NPT	10.4 x 9 x 6" 26.4 x 22.8 x 15.2 cm	20.9 x 13.5 x 14.9" 53.1 x 34.2 x 37.8 cm	I (NFL)	•	•	Acc		95°	35°	240/50/1/10	60	27.2	AD20S150
Variable	3.6	0.25	4.4	16.7	3.2	12.2	1/4" (F) NPT	10.1 x 8.4 x 8" 25.7 x 21.4 x 20.3 cm	20.9 x 13.5 x 16.9" 53.1 x 34.2 x 42.9 cm	I (NFL)	•	•	Acc		95°	35°	240/50/1/10	72	32.6	AD28S150
One	1.5	0.1	2.8	10.6			1/2" O.D. Barbed Tubes	3.9 x 4.3 x 6" 10 x 11 x 15.2 cm	13.4 x 8.1 x 16" 34 x 20.6 x 40.6 cm	I (NFL)	•	•			95°	35°	240/50/1/6	20	9.1	MX06S135
One	1.5	0.1	2.8	10.6			1/2" O.D. Barbed Tubes	3.9 x 10.1 x 6" 9.9 x 25.5 x 15.2 cm	13.9 x 13.5 x 16" 35.3 x 34.2 x 40.6 cm	I (NFL)	•	•	Acc		95°	35°	240/50/1/6	39	17.7	MX10S135
One	1.5	0.1	2.8	10.6			1/2" O.D. Barbed Tubes	10.4 x 9 x 6" 26.4 x 22.8 x 15.2 cm	20.9 x 13.5 x 16" 53.1 x 34.2 x 40.6 cm	I (NFL)	•	•	Acc		95°	35°	240/50/1/6	54	24.5	MX20S135
One	1.5	0.1	2.8	10.6			1/2" O.D. Barbed Tubes	10.1 x 8.4 x 8" 25.7 x 21.4 x 20.3 cm	20.9 x 13.5 x 18" 53.1 x 34.2 x 45.7 cm	I (NFL)	•	•	Acc		95°	35°	240/50/1/6	66	29.9	MX28S135
Variable	3.6	0.25	4.4	16.7	3.2	12.2	1/4" (F) NPT	4.1 x 6.1 x 8" 10.5 x 15.6 x 20.3 cm	12.7 x 8.2 x 16.3" 32.2 x 20.8 x 41.3 cm	I (NFL)	•	•			95°	35°	240/50/1/10	22	10.0	AP08P100
Variable	3.6	0.25	4.4	16.7	3.2	12.2	1/4" (F) NPT	8.3 x 6.1 x 8" 21 x 15.6 x 20.3 cm	16.8 x 8.2 x 16.3" 42.7 x 20.8 x 41.3 cm	I (NFL)	•	•			95°	35°	240/50/1/10	27	12.2	AP11P100
Variable	3.6	0.25	4.4	16.7	3.2	12.2	1/4" (F) NPT	12.4 x 6.1 x 8" 31.4 x 15.6 x 20.3 cm	20.9 x 8.2 x 16.3" 53.2 x 20.8 x 41.3 cm	I (NFL)	•	•			95°	35°	240/50/1/10	30	13.6	AP14P100
Variable	3.6	0.25	4.4	16.7	3.2	12.2	1/4" (F) NPT	4.1 x 12 x 8" 10.5 x 30.5 x 20.3 cm	13.9 x 13.6 x 16.3" 35.3 x 34.5 x 41.3 cm	I (NFL)	•	•	Acc		95°	35°	240/50/1/10	38	17.2	AP17P100
Variable	3.6	0.25	4.4	16.7	3.2	12.2	1/4" (F) NPT	8.3 x 12 x 8" 21 x 30.5 x 20.3 cm	18 x 13.6 x 16.3" 45.7 x 34.5 x 41.3 cm	I (NFL)	•	•	Acc		95°	35°	240/50/1/10	51	23.1	AP23P100
Variable	3.6	0.25	4.4	16.7	3.2	12.2	1/4" (F) NPT	12.4 x 12 x 8" 31.5 x 30.5 x 20.3 cm	22.1 x 13.6 x 16.3" 56.2 x 34.5 x 41.3 cm	I (NFL)	•	•	Acc		95°	35°	240/50/1/10	62	28.1	AP28P100
One	1.5	0.1	2.8	10.6			1/2" O.D. Barbed Tubes	4.1 x 6.1 x 8" 10.5 x 15.6 x 20.3 cm	12.7 x 8.2 x 17.4" 32.2 x 20.8 x 44.1 cm	I (NFL)	•	•			95°	35°	240/50/1/6	16	7.2	MX08P100
One	1.5	0.1	2.8	10.6			1/2" O.D. Barbed Tubes	8.3 x 6.1 x 8" 21 x 15.6 x 20.3 cm	16.8 x 8.2 x 17.4" 42.7 x 20.8 x 44.1 cm	I (NFL)	•	•			95°	35°	240/50/1/6	21	9.5	MX11P100
One	1.5	0.1	2.8	10.6			1/2" O.D. Barbed Tubes	12.4 x 6.1 x 8" 31.4 x 15.6 x 20.3 cm	20.9 x 8.2 x 17.4" 53.2 x 20.8 x 44.1 cm	I (NFL)	•	•			95°	35°	240/50/1/6	24	10.9	MX14P100
One	1.5	0.1	2.8	10.6			1/2" O.D. Barbed Tubes	4.1 x 12 x 8" 10.5 x 30.5 x 20.3 cm	13.9 x 13.6 x 17.4" 35.3 x 34.5 x 44.1 cm	I (NFL)	•	•	Acc		95°	35°	240/50/1/6	32	14.5	MX17P100
One	1.5	0.1	2.8	10.6			1/2" O.D. Barbed Tubes	8.3 x 12 x 8" 21 x 30.5 x 20.3 cm	18 x 13.6 x 17.4" 45.7 x 34.5 x 44.1 cm	I (NFL)	•	•	Acc		95°	35°	240/50/1/6	45	20.4	MX23P100
One	1.5	0.1	2.8	10.6			1/2" O.D. Barbed Tubes	12.4 x 12 x 8" 31.5 x 30.5 x 20.3 cm	22.1 x 13.6 x 17.4" 56.2 x 34.5 x 44.1 cm	I (NFL)	•	•	Acc		95°	35°	240/50/1/6	56	25.4	MX28P100

# Technical Specifications

## Specialty Products, 50 Hz Models

Model	Description	Catalog Page Number	Controller Type	Temperature Range		Temperature Stability		Display Resolution		Reservoir Capacity gal/ltr	Tank Material	Heater Wattage	Display/Interface	Pump Type
				°F	°C	°F	°C	Set	Read					
PP75R-20-A12E	75 L, Ref. Circulator	74	Performance Programmable	-4° to 212°	-20° to 100°	±0.01°	±0.005°	0.01	0.001	19.81/75	Stainless steel	2200	4.3" SmartTouch Touchscreen	Pressure/Suction
AP29VB5R-A12E	Viscosity Bath, 29 L, 5 Round	70-71	Advanced Programmable	Ambient +20° to 185°	Ambient +10° to 85°	±0.02°	±0.01°	0.01	0.001	7.66/29	Polycarbonate	2200	4.3" SmartTouch Touchscreen	Pressure/Suction
AP29VB3S-A12E	Viscosity Bath, 29 L, 3 Square	70-71	Advanced Programmable	Ambient +20° to 185°	Ambient +10° to 85°	±0.02°	±0.01°	0.01	0.001	7.66/29	Polycarbonate	2200	4.3" SmartTouch Touchscreen	Pressure/Suction
AD29VB5R-A12E	Viscosity Bath, 29 L, 5 Round	70-71	Advanced Digital	Ambient +20° to 185°	Ambient +10° to 85°	±0.02°	±0.01°	0.01	0.01	7.66/29	Polycarbonate	2200	3.75" Touch-Pad LCD	Pressure/Suction
AD29VB3S-A12E	Viscosity Bath, 29 L, 3 Square	70-71	Advanced Digital	Ambient +20° to 185°	Ambient +10° to 85°	±0.02°	±0.01°	0.01	0.01	7.66/29	Polycarbonate	2200	3.75" Touch-Pad LCD	Pressure/Suction
SD29VB5R-A12E	Viscosity Bath, 29 L, 5 Round	70-71	Standard Digital	Ambient +20° to 185°	Ambient +10° to 85°	±0.08°	±0.04°	0.01	0.01	7.66/29	Polycarbonate	2200	3.75" Touch-Pad LCD	Pressure
SD29VB3S-A12E	Viscosity Bath, 29 L, 3 Square	70-71	Standard Digital	Ambient +20° to 185°	Ambient +10° to 85°	±0.08°	±0.04°	0.01	0.01	7.66/29	Polycarbonate	2200	3.75" Touch-Pad LCD	Pressure
MX17VB6G-A12E	Viscosity Bath, 17 L, 6 Round	70-71	MX	Ambient +20° to 275°	Ambient +10° to 135°	±0.13°	±0.07°	0.1	0.1	4.49/17	Glass	1100	3.25" LCD	Pressure
MX27VB6G-A12E	Viscosity Bath, 27 L, 6 Round	70-71	MX	Ambient +20° to 275°	Ambient +10° to 135°	±0.13°	±0.07°	0.1	0.1	7.13/27	Glass	1100	3.25" LCD	Pressure
PPI5HCAL-A12E	Calibration Bath, 15 L, Htg.	72-73	Performance Programmable	Ambient + 20° to 392°	Ambient + 10° to 200°	±0.01°	±0.005°	0.01	0.001	3.96/15	Stainless Steel	2200	4.3" SmartTouch Touchscreen	Pressure/Suction
PD15HCAL-A12E	Calibration Bath, 15 L, Htg.	72-73	Performance Digital	Ambient + 20° to 392°	Ambient + 10° to 200°	±0.01°	±0.005°	0.01	0.001	3.96/15	Stainless Steel	2200	4.3" SmartTouch Touchscreen	Pressure/Suction
PPI5RCAL-A12E	Calibration Bath, 15 L, Ref.	72-73	Performance Programmable	-22° to 392°	-30° to 200°	±0.01°	±0.005°	0.01	0.001	3.96/15	Stainless Steel	2200	4.3" SmartTouch Touchscreen	Pressure/Suction
PD15RCAL-A12E	Calibration Bath, 15 L, Ref.	72-73	Performance Digital	-22° to 392°	-30° to 200°	±0.01°	±0.005°	0.01	0.001	3.96/15	Stainless Steel	2200	4.3" SmartTouch Touchscreen	Pressure/Suction
6250B2CRY30E	Cryoprecipitate Bath	75	Digital	Set-point Fixed @ 39.2°F	Set-point Fixed @ 4°C	±0.2°	±0.1°C	0.1	0.1	13.8/52	Stainless Steel		Two Digital Readouts	Pressure
T13RSA12E	13 L Refrigerated Open Bath	75		32° to 302°F	0° to 150°C					3.4/13	Stainless Steel			
HBATH-60-A12E	Histology Bath	76		Fixed at -76°	Fixed at -60°					0.50/1.9	Stainless Steel			
HPLAT-30-A12E	Histology Freeze Plate	76		Fixed at -30°	Fixed at -34.4°									
MX28C135-A12E	Coliform Bath, 28 L	77	MX	Ambient +20° to 275°	Ambient +10° to 135°	±0.13°	±0.07°	0.1	0.1	7.40/28	Stainless Steel	1100	3.25" LCD	Pressure

## Low Temperature Coolers, 50 Hz Models

Model	Description	Catalog Page Number	Temperature Range		Temperature Control		Temperature Readout	Cooling Capacity @ (W)			
			°F	°C	°F	°C		-100°C	-80°C	-65°C	-40°C
IP-100 (RC)	Immersion Probe 3" Rigid Coil	114-115	-148° to -76°	-100° to -60°	Fixed @ -148°	Fixed @ -100°	•	0	35	85	130
IP-100 (CF)	Immersion Probe Rigid Cold Finger	114-115	-148° to -76°	-100° to -60°	Fixed @ -148°	Fixed @ -100°	•	0	35	85	130
IP-100 (FP)	Immersion Probe Flexible Cold Finger	114-115	-148° to -76°	-100° to -60°	Fixed @ -148°	Fixed @ -100°	•	0	35	85	130
IP-80 (RC)	Immersion Probe 1.5" Rigid Coil	114-115	-112° to -40°	-80° to -40°	Fixed @ -112°	Fixed @ -80°	•		85	150	
IP-60 (RC)	Immersion Probe 1.5" Rigid Coil	114-115	-76° to -4°	-60° to -20°	Fixed @ -76°	Fixed @ -60°			0	20	
IP-35 (RC)	Immersion Probe 3" Rigid Coil	114-115	-31° to +104°	-35° to +40°	Fixed @ -31°	Fixed @ -35°					
IP-35 (RC)	Immersion Probe 1.75" Rigid Coil	114-115	-31° to +104°	-35° to +40°	Fixed @ -31°	Fixed @ -35°					
FT-25	Flow-Through	115	-13° to +104°	-25° to +40°	Fixed @ -13°	Fixed @ -25°					

Pump Speeds	Maximum Pressure		Maximum Pressure Flow Rate		Maximum Suction Flow Rate		Process Connections	Working Access	Overall Dimensions	Flammability Class	Over-Temperature Protection/Failsafe Heater Control	Low Level Protection	Reservoir Drain Cooling Coil	Maximum Ambient Temperature		Electrical Requirements	Shipping Weight		Model
	psi	bar	gpm	l/min	gpm	l/min								L x W x D	L x W x H		°F	°C	
Variable	3.6	0.25	4.4	16.7	3.2	12.2	1/4" (F) NPT	21.6 x 15.7 x 9.4" 54.9 x 39.8 x 23.9 cm	35.8 x 22.4 x 42.1" 90.9 x 56.9 x 107 cm	III (FL)	•	•	•	95°	35°	208-240/50-60/1/13	200	90.6	PP75R-20-A12E
Variable	3.6	0.25	4.4	16.7	3.2	12.2	1/4" (F) NPT	(5) x 2 Ø x 11.25" (5) x 5.1 Ø x 28.6 cm	21.4 x 9 x 20.7" 54.4 x 22.9 x 52.6 cm	I (NFL)	•	•	•	95°	35°	240/50/1/10	75	34.0	AP29VB5R-A12E
Variable	3.6	0.25	4.4	16.7	3.2	12.2	1/4" (F) NPT	(3) x 3.5 x 3.5 x 11.25" (3) x 8.9 x 8.9 x 28.6 cm	21.4 x 9 x 20.7" 54.4 x 22.9 x 52.6 cm	I (NFL)	•	•	•	95°	35°	240/50/1/10	75	34.0	AP29VB3S-A12E
Variable	3.6	0.25	4.4	16.7	3.2	12.2	1/4" (F) NPT	(5) x 2 Ø x 11.25" (5) x 5.1 Ø x 28.6 cm	21.4 x 9 x 20.7" 54.4 x 22.9 x 52.6 cm	I (NFL)	•	•	•	95°	35°	240/50/1/10	75	34.0	AD29VB5R-A12E
Variable	3.6	0.25	4.4	16.7	3.2	12.2	1/4" (F) NPT	(3) x 3.5 x 3.5 x 11.25" (3) x 8.9 x 8.9 x 28.6 cm	21.4 x 9 x 20.7" 54.4 x 22.9 x 52.6 cm	I (NFL)	•	•	•	95°	35°	240/50/1/10	75	34.0	AD29VB3S-A12E
Two	2.9	0.2	2.7	10.2			1/4" (F) NPT	(5) x 2 Ø x 11.25" (5) x 5.1 Ø x 28.6 cm	21.4 x 9 x 20.7" 54.4 x 22.9 x 52.6 cm	I (NFL)	•	•	•	95°	35°	240/50/1/10	75	34.0	SD29VB5R-A12E
Two	2.9	0.2	2.7	10.2			1/4" (F) NPT	(3) x 3.5 x 3.5 x 11.25" (3) x 8.9 x 8.9 x 28.6 cm	21.4 x 9 x 20.7" 54.4 x 22.9 x 52.6 cm	I (NFL)	•	•	•	95°	35°	240/50/1/10	75	34.0	SD29VB3S-A12E
One	1.5	0.10	2.8	10.6			1/2" O.D. Barbed Tubes	(6) x 2 Ø x 11" (6) x 5.1 Ø x 27.9 cm	12.5 Ø x 20.5" 31.8 Ø x 52.1 cm	I (NFL)	•	•	•	95°	35°	240/50/1/6	35	15.9	MX17VB5G-A12E
One	1.5	0.10	2.8	10.6			1/2" O.D. Barbed Tubes	(6) x 2 Ø x 17" (6) x 5.1 Ø x 43.2 cm	12.5 Ø x 26.4" 31.8 Ø x 67.0 cm	I (NFL)	•	•	•	95°	35°	240/50/1/6	45	20.4	MX27VB5G-A12E
Variable	3.6	0.25	4.4	16.7	3.2	12.2	1/4" (F) NPT	4.6 Ø x 11" 11.7 Ø x 28 cm	21.3 x 8.7 x 24.3" 54.1 x 22.1 x 61.7 cm	III (FL)	•	•	•	95°	35°	240/50/1/10	50	22.7	PP15HCALB-A12E
Variable	3.6	0.25	4.4	16.7	3.2	12.2	1/4" (F) NPT	4.6 Ø x 11" 11.7 Ø x 28 cm	21.3 x 8.7 x 24.3" 54.1 x 22.1 x 61.7 cm	III (FL)	•	•	•	95°	35°	240/50/1/10	50	22.7	PD15HCALB-A12E
Variable	3.6	0.25	4.4	16.7	3.2	12.2	1/4" (F) NPT	4.6 Ø x 11" 11.7 Ø x 28 cm	21.3 x 8.7 x 30.5" 54.1 x 22.1 x 77.5 cm	III (FL)	•	•	•	95°	35°	240/50/1/13	100	45.3	PP15RCALB-A12E
Variable	3.6	0.25	4.4	16.7	3.2	12.2	1/4" (F) NPT	4.6 Ø x 11" 11.7 Ø x 28 cm	21.3 x 8.7 x 30.5" 54.1 x 22.1 x 77.5 cm	III (FL)	•	•	•	95°	35°	240/50/1/13	100	45.3	PD15RCALB-A12E
One								20.6 x 13 x 12" 52.4 x 33 x 30.5 cm	28 x 14.5 x 36.6" 71.1 x 37 x 93 cm		•	•	•	95°	35°	240/50/1/6.3	200	90.6	6250B2CRY30E
								9 x 11.75 x 7.75" 22.9 x 29.8 x 19.7 cm	13.5 x 22 x 10" 34.3 x 55.9 x 25.4 cm	I (NFL)				95°	35°	245/50/1/1.5	58	26	T13RSA12E
								4.8 Ø x 6.6" 12.2 Ø x 16.8 cm	22.75 x 11 x 11" 57.8 x 27.9 x 27.9 cm					95°	35°	240/50/1/2.5	75	34.0	HBATH-60-A12E
								14.5 x 9.4" 36.8 x 23.8 cm	15.9 x 18.4 x 10.5" 40.3 x 46.7 x 26.7 cm					95°	35°	240/50/1/3.5	76	34.4	HPLAT-30-A12E
One	1.5	0.10	2.8	10.6			1/2" O.D. Barbed Tubes	11.8 x 12.9 x 8.3" 30 x 32.8 x 21.1 cm	13.9 x 21.5 x 18" 35.3 x 54.6 x 45.7 cm	I (NFL)	•	•	•	95°	35°	240/50/1/6	66	29.9	MX28C135-A12E

Cooling Capacity @ (W)				Process Connections				Overall Dimensions L x W x H	Maximum Ambient Temperature		Refrigerant	Electrical Requirements VAC/Hz/Ph/A	Shipping Weight		Model
-30°C	-20°C	-10°C	0°C	+10°C	+20°C	+30°C	+40°C		°F	°C			lb	kg	
								20.1 x 15 x 22.3" 51.1 x 38.1 x 56.6 cm	86°	30°	R404A & R508B	240/50/1/7.5	162	73.5	IP-100 (RC)
								20.1 x 15 x 22.3" 51.1 x 38.1 x 56.6 cm	86°	30°	R404A & R508B	240/50/1/7.5	162	73.5	IP-100 (CF)
								20.1 x 15 x 22.3" 51.1 x 38.1 x 56.6 cm	86°	30°	R404A & R508B	240/50/1/7.5	162	73.5	IP-100 (FP)
								20.1 x 15 x 22.3" 51.1 x 38.1 x 56.6 cm	86°	30°	R404A & R508B	240/50/1/7.5	162	73.5	IP-80 (RC)
45	65							11 x 10 x 9" 27.9 x 25.4 x 22.9 cm	86°	30°	R502 & R508B	240/50/1/2.5	49	22.0	IP-60 (RC)
100	140	233	388	647	924	1,109	1,220	17 x 14 x 14" 43.2 x 35.6 x 35.6 cm	86°	30°	R134a	240/50/1/2.5	76	34.0	IP-35 (RC)
91	130	216	360	601	858	1,030	1,133	17 x 14 x 14" 43.2 x 35.6 x 35.6 cm	86°	30°	R134a	240/50/1/2.5	78	35.4	IP-35 (RC)
	100	165	275	459	656	787	865	17 x 14 x 14" 43.2 x 35.6 x 35.6 cm	86°	30°	R134a	240/50/1/2.5	73	33.1	FT-25

# Technical Specifications

## General Purpose Water Baths, 50 Hz Models

Model	Description	Catalog Page Number	Controller Type	Temperature Range		Temperature Stability		Reservoir Capacity gal/ltr	Tank Material
				°F	°C	°F	°C		
WD02A12E	General Purpose Water Bath, Digital, 2 L	86-87	Digital	Ambient +10° to 212°	Ambient +5° to 100°	±0.5°	±0.25°	0.53/2	Stainless Steel
WD2SA12E	General Purpose Water Bath, Digital, 2 L	86-87	Digital	Ambient +10° to 212°	Ambient +5° to 100°	±0.5°	±0.25°	0.53/2	Stainless Steel
WD05A12E	General Purpose Water Bath, Digital, 5 L	86-87	Digital	Ambient +10° to 212°	Ambient +5° to 100°	±0.5°	±0.25°	1.32/5	Stainless Steel
WD10A12E	General Purpose Water Bath, Digital, 10 L	86-87	Digital	Ambient +10° to 212°	Ambient +5° to 100°	±0.5°	±0.25°	2.64/10	Stainless Steel
WD20A12E	General Purpose Water Bath, Digital, 20 L	86-87	Digital	Ambient +10° to 212°	Ambient +5° to 100°	±0.5°	±0.25°	5.28/20	Stainless Steel
WD28A12E	General Purpose Water Bath, Digital, 28 L	86-87	Digital	Ambient +10° to 212°	Ambient +5° to 100°	±0.5°	±0.25°	7.40/28	Stainless Steel
WA02A12E	General Purpose Water Bath, Economy, 2 L	88-89	Dial	Ambient +10° to 212°	Ambient +5° to 100°	±0.5°	±0.25°	0.53/2	Stainless Steel
WA2SA12E	General Purpose Water Bath, Economy, 2 L	88-89	Dial	Ambient +10° to 212°	Ambient +5° to 100°	±0.5°	±0.25°	0.53/2	Stainless Steel
WA05A12E	General Purpose Water Bath, Economy, 5 L	88-89	Dial	Ambient +10° to 212°	Ambient +5° to 100°	±0.5°	±0.25°	1.32/5	Stainless Steel
WA10A12E	General Purpose Water Bath, Economy, 10 L	88-89	Dial	Ambient +10° to 212°	Ambient +5° to 100°	±0.5°	±0.25°	2.64/10	Stainless Steel
WA20A12E	General Purpose Water Bath, Economy, 20 L	88-89	Dial	Ambient +10° to 212°	Ambient +5° to 100°	±0.5°	±0.25°	5.28/20	Stainless Steel
WA28A12E	General Purpose Water Bath, Economy, 28 L	88-89	Dial	Ambient +10° to 212°	Ambient +5° to 100°	±0.5°	±0.25°	7.40/28	Stainless Steel

## Recirculating Coolers, 50 Hz Models

Model	Description	Catalog Page Number	Temperature Range		Temperature Stability		Reservoir Capacity gal/ltr	Cooling Capacity @ 10-11°C ΔT (W)	Facility Water In @ 20°C (W)	Pump Type
			°F	°C	°F	°C				
3370P9A12E	Liquid-to-Air Cooler, Positive Displacement	107	Ambient +10° to 158°	Ambient +5° to 70°C	N/A	N/A	1.11/4.2	4,000		Positive Displacement
3370TBA12E	Liquid-to-Air Cooler, Turbine	107	Ambient +10° to 158°	Ambient +5° to 70°C	N/A	N/A	1.11/4.2	4,000		Turbine
4150T21A330D	Liquid-to-Liquid Cooler	108	Facility water +20° to 140°	Facility water +10° to 60°	±0.8°	±0.4°	1.11/4.2	10,000	10 lpm	Turbine

Heater Wattage	Working Access L x W x D	Overall Dimensions L x W x H	Over- Temperature Protection	Maximum Ambient Temperature		Electrical Requirements VAC/Hz/Ph/A	Shipping Weight		Model
				°F	°C		lb	kg	
300	3.9 x 4.3 x 5.5" 9.9 x 10.9 x 14 cm	10.2 x 8 x 11.8" 25.9 x 20.3 x 30 cm	•	86°	30°	240/50/1/1.25	10	4.5	WD02A12E
300	5 x 10.8 x 1.9" 12.7 x 27.4 x 4.8 cm	10.6 x 13.6 x 12" 26.9 x 34.5 x 30.4 cm	•	86°	30°	240/50/1/1.25	10	4.5	WD2SA12E
500	5 x 10.8 x 5.5" 12.7 x 27.4 x 14 cm	10.6 x 13.6 x 12" 26.9 x 34.5 x 30.4 cm	•	86°	30°	240/50/1/2.1	14	6.3	WD05A12E
500	10.6 x 11.6 x 5.5" 26.9 x 29.5 x 14 cm	16.7 x 14.8 x 11.8" 42.1 x 37.6 x 30 cm	•	86°	30°	240/50/1/2.1	19	8.6	WD10A12E
1000	9.5 x 17.5 x 5" 24.1 x 44.5 x 12.7 cm	16.4 x 21.6 x 12" 41.5 x 54.8 x 30.5 cm	•	86°	30°	240/50/1/4.15	26	11.8	WD20A12E
1000	9.5 x 17.5 x 7" 24.1 x 44.5 x 17.8 cm	16.4 x 21.6 x 14.1" 41.5 x 54.8 x 35.8 cm	•	86°	30°	240/50/1/4.15	29	13.1	WD28A12E
300	3.9 x 4.3 x 5.5" 9.9 x 10.9 x 14 cm	11 x 8 x 11.8" 27.7 x 20.3 x 30 cm	•	86°	30°	240/50/1/1.25	10	4.5	WA02A12E
300	5 x 10.8 x 1.9" 12.7 x 27.4 x 4.8 cm	11.4 x 13.6 x 12" 28.9 x 34.5 x 30.4 cm	•	86°	30°	240/50/1/1.25	10	4.5	WA2SA12E
500	5 x 10.8 x 5.5" 12.7 x 27.4 x 14 cm	11.4 x 13.6 x 12" 28.9 x 34.5 x 30.4 cm	•	86°	30°	240/50/1/2.1	14	6.3	WA05A12E
500	10.6 x 11.6 x 5.5" 26.9 x 29.5 x 14 cm	17.5 x 14.8 x 11.8" 44.5 x 37.6 x 30 cm	•	86°	30°	240/50/1/2.1	19	8.6	WA10A12E
1000	9.5 x 17.5 x 5" 24.1 x 44.5 x 12.7 cm	17.1 x 21.6 x 12" 43.4 x 54.8 x 30.5 cm	•	86°	30°	240/50/1/4.15	26	11.8	WA20A12E
1000	9.5 x 17.5 x 7" 24.1 x 44.5 x 17.8 cm	17.1 x 21.6 x 14.1" 43.4 x 54.8 x 35.8 cm	•	86°	30°	240/50/1/4.15	29	13.1	WA28A12E

Maximum Pump Pressure		Maximum Pump Flow		Process Connections	Overall Dimensions L x W x H	Maximum Ambient Temperature		Refrigerant	Electrical Requirements VAC/Hz/Ph/A	Shipping Weight		Model
psi	bar	gpm	l/min			°F	°C			lb	kg	
100	6.9	2	7.6	1/2" (F) NPT	20.5 x 15 x 22.3" 52 x 38.1 x 54.6 cm	95°	35°		240/50/1/3	132	59.9	3370P9A12E
50	3.4	4.5	17.1	1/2" (F) NPT	20.5 x 15 x 22.3" 52 x 38.1 x 54.6 cm	95°	35°		240/50/1/3	133	59.9	3370TBA12E
83	5.7	2.9	11	1/2" (F) NPT	27.6 x 14.5 x 22.6" 70.2 x 36.8 x 57.5 cm	95°	35°		240/50/1/3	175	79.5	4150T21A330D

# Technical Specifications

## Chillers: Benchtop, 6000 Series and DuraChill™, 50 Hz Models

Model	Description	Catalog Page Number	Temperature Range		Temperature Stability		Reservoir Capacity gal/ltr	Cooling Capacity @ (W)								
			°F	°C	°F	°C		50°C	40°C	30°C	20°C	10°C	0°C	-5°C	-10°C	-20°C
			LS52TY1A110E	Chiller, 1/2 HP, Recirculating	98-99	-4° to 104°		-20° to 40°	±0.2°	±0.1°	0.70/2.65	1,105	990	830	750	500
LS52MY1A110E	Chiller, 1/2 HP, Recirculating	98-99	-4° to 104°	-20° to 40°	±0.2°	±0.1°	0.70/2.65	1,580	1,420	1,190	1,070	700	560	460	240	
LS52M21A110E	Chiller, 1/2 HP, Recirculating	98-99	-4° to 104°	-20° to 40°	±0.2°	±0.1°	0.70/2.65	1,545	1,380	1,160	1,030	680	510	435	230	
LM62MY1A110E	Chiller, 1/3 HP, Recirculating	100	14 to 86°	-10° to 30°	±0.2°	±0.1°	0.70/2.65		500	390	280	170	135	110		
LM62GY1A110E	Chiller, 1/3 HP, Recirculating	100	14 to 86°	-10° to 30°	±0.2°	±0.1°	0.70/2.65		600	520	390	250	180	140		
MM72MY1A110E	Chiller, 1/10 HP, Recirculating	101	23 to 122°	-5° to 50°	±0.2°	±0.1°	0.70/2.65	480	450	420	390	270	175	105		
MM72GY1A110E	Chiller, 1/10 HP, Recirculating	101	23 to 122°	-5° to 50°	±0.2°	±0.1°	0.70/2.65	495	470	440	410	290	190	115		
6250T21A130E	Chiller, 1/4 HP, Recirculating	102-103	14° to 104°	-10° to 40°	±0.2°	±0.1°	1.11/4.2	1,025	950	700	500	300	185	75		
6350T21A130E	Chiller, 1/3 HP, Recirculating	102-103	14° to 104°	-10° to 40°	±0.2°	±0.1°	1.11/4.2	1,411	1,370	1,280	935	485	330	180		
6550T21A130E	Chiller, 1/2 HP, Recirculating	102-103	14° to 104°	-10° to 40°	±0.2°	±0.1°	1.11/4.2	1,956	1,899	1,775	1,140	765	525	290		
6750T21A130E	Chiller, 3/4 HP, Recirculating	102-103	14° to 104°	-10° to 40°	±0.2°	±0.1°	1.11/4.2	2,425	2,354	2,200	1,500	975	710	450		
6150T21A130E	Chiller, 1 HP, Recirculating	102-103	14° to 104°	-10° to 40°	±0.2°	±0.1°	1.11/4.2	2,921	2,836	2,650	1,900	1,200	900	600		
6250P21A130E	Chiller, 1/4 HP, Recirculating	102-103	14° to 104°	-10° to 40°	±0.2°	±0.1°	1.11/4.2	1,025	950	700	500	300	185	75		
6350P21A130E	Chiller, 1/3 HP, Recirculating	102-103	14° to 104°	-10° to 40°	±0.2°	±0.1°	1.11/4.2	1,411	1,370	1,280	935	485	330	180		
6550P21A130E	Chiller, 1/2 HP, Recirculating	102-103	14° to 104°	-10° to 40°	±0.2°	±0.1°	1.11/4.2	1,956	1,899	1,775	1,140	765	525	290		
6750P41A130E	Chiller, 3/4 HP, Recirculating	102-103	14° to 104°	-10° to 40°	±0.2°	±0.1°	1.11/4.2	2,425	2,354	2,200	1,500	975	710	450		
6150P41A130E	Chiller, 1 HP, Recirculating	102-103	14° to 104°	-10° to 40°	±0.2°	±0.1°	1.11/4.2	2,921	2,836	2,650	1,900	1,200	900	600		
6250M21A130E	Chiller, 1/4 HP, Recirculating	102-103	14° to 104°	-10° to 40°	±0.2°	±0.1°	1.11/4.2	1,125	1,050	800	600	400	260	125		
6350M21A130E	Chiller, 1/3 HP, Recirculating	102-103	14° to 104°	-10° to 40°	±0.2°	±0.1°	1.11/4.2	1,300	1,263	1,180	960	600	400	215		
6550M21A130E	Chiller, 1/2 HP, Recirculating	102-103	14° to 104°	-10° to 40°	±0.2°	±0.1°	1.11/4.2	1,956	1,899	1,775	1,140	765	525	290		
6750M21A130E	Chiller, 3/4 HP, Recirculating	102-103	14° to 104°	-10° to 40°	±0.2°	±0.1°	1.11/4.2	2,480	2,408	2,250	1,600	1,075	760	450		
6150M21A130E	Chiller, 1 HP, Recirculating	102-103	14° to 104°	-10° to 40°	±0.2°	±0.1°	1.11/4.2	3,031	2,943	2,750	2,050	1,400	1,075	750		
6850 (380V/3PH)	Chiller, 1.5 HP, Recirculating	104	41° to 95°	5° to 35°	±0.9°	±0.5°	3.5/13.25		5,949	4,576	3,203					
6850 (220V/3PH)	Chiller, 1.5 HP, Recirculating	104	41° to 95°	5° to 35°	±0.9°	±0.5°	3.5/13.25		5,949	4,576	3,203					
6850P46A270E	Chiller, 1.5 HP, Recirculating	104	41° to 95°	5° to 35°	±0.9°	±0.5°	3.5/13.25		5,949	4,576	3,203					
6950P46A270E	Chiller, 1.5 HP, Recirculating	104	41° to 95°	5° to 35°	±0.9°	±0.5°	3.5/13.25		5,960	5,569	3,900					
DCA200 (380V/3PH)	Chiller, 2 HP, Recirculating	105	41° to 95°	5° to 35°	±0.9°	±0.5°	7.00/26.5		8,008	6,160	4,312					
DCA200 (220V/3PH)	Chiller, 2 HP, Recirculating	105	41° to 95°	5° to 35°	±0.9°	±0.5°	7.00/26.5		8,008	6,160	4,312					
DCA300 (380V/3PH)	Chiller, 3 HP, Recirculating	105	41° to 95°	5° to 35°	±0.9°	±0.5°	7.00/26.5		12,012	9,240	6,468					
DCA300 (220V/3PH)	Chiller, 3 HP, Recirculating	105	41° to 95°	5° to 35°	±0.9°	±0.5°	7.00/26.5		12,012	9,240	6,468					
DCW300 (220V/3PH)	Chiller, 3 HP, Recirculating	105	41° to 95°	5° to 35°	±0.9°	±0.5°	7.00/26.5		10,298	9,624	6,737					
DA500 (380V/3PH)	Chiller, 5 HP, Recirculating	106	32° to 86°	0° to 30°	±2.0°	±1.1°	16.00/60.5		24,366	18,743	14,418	8,651				
DA500 (220V/3PH)	Chiller, 5 HP, Recirculating	106	32° to 86°	0° to 30°	±2.0°	±1.1°	16.00/60.5		24,366	18,743	14,418	8,651				
DA750 (380V/3PH)	Chiller, 7.5 HP, Recirculating	106	32° to 86°	0° to 30°	±2.0°	±1.1°	45.00/170		33,255	25,581	19,678	11,807				
DA1000 (380V/3PH)	Chiller, 10 HP, Recirculating	106	32° to 86°	0° to 30°	±2.0°	±1.1°	45.00/170		49,726	38,251	29,424	17,654				



Compressor Size	Heater Option	Pump Type	Maximum Pressure		Maximum Pressure Flow Rate		Process Connections	Overall Dimensions	Maximum Ambient Temperature		Refrigerant	Electrical Requirements	Shipping Weight		Model
			psi	bar	gpm	l/min			°F	°C			lb	kg	
1/2		Turbine	32	2.20	2.2	8.3	1/2" (F) NPT	23.9 x 10 x 19" 60.7 x 25.4 x 48.3 cm	95°	35°	R404A	240/50/1/6	102	46.3	LS52TY1A110E
1/2		Centrifugal	10.5	0.72	3.1	11.7	1/2" (F) NPT	23.9 x 10 x 19" 60.7 x 25.4 x 48.3 cm	95°	35°	R404A	240/50/1/6	102	46.3	LS52MY1A110E
1/2		Centrifugal	5.5	0.40	3.4	12.9	1/2" (F) NPT	23.9 x 10 x 19" 60.7 x 25.4 x 48.3 cm	95°	35°	R404A	240/50/1/6	102	46.3	LS52M21A110E
1/3		Centrifugal	12.5	0.90	3	11.4	1/2" (F) NPT	20 x 10 x 17" 50.8 x 25.4 x 43.2 cm	95°	35°	R404A	240/50/1/5	75	34.5	LM62MY1A110E
1/3		Centrifugal	4.4	0.30	1.8	6.8	1/2" (F) NPT	20 x 10 x 17" 50.8 x 25.4 x 43.2 cm	95°	35°	R404A	240/50/1/5	75	34.5	LM62GY1A110E
1/10		Centrifugal	12.5	0.90	3	11.4	1/2" (F) NPT	20 x 10 x 17" 50.8 x 25.4 x 43.2 cm	95°	35°	R134a	240/50/1/4.5	75	34.5	MM72MY1A110E
1/10		Centrifugal	4.4	0.30	1.8	6.8	1/2" (F) NPT	20 x 10 x 17" 50.8 x 25.4 x 43.2 cm	95°	35°	R134a	240/50/1/4.5	75	34.5	MM72GY1A110E
1/4	•	Turbine	83	5.72	2.9	11	1/2" (F) NPT	27.6 x 14.5 x 22.6" 70.2 x 36.8 x 57.5 cm	95°	35°	R134a	240/50/1/6.8	143	64.8	6250T21A130E
1/3	•	Turbine	83	5.72	2.9	11	1/2" (F) NPT	27.6 x 14.5 x 22.6" 70.2 x 36.8 x 57.5 cm	95°	35°	R134a	240/50/1/7.3	156	71.0	6350T21A130E
1/2	•	Turbine	83	5.72	2.9	11	1/2" (F) NPT	27.6 x 14.5 x 22.6" 70.2 x 36.8 x 57.5 cm	95°	35°	R134a	240/50/1/8.9	181	82.0	6550T21A130E
3/4	•	Turbine	83	5.72	2.9	11	1/2" (F) NPT	27.6 x 14.5 x 22.6" 70.2 x 36.8 x 57.5 cm	95°	35°	R134a	240/50/1/11.9	197	89.0	6750T21A130E
1	•	Turbine	83	5.72	2.9	11	1/2" (F) NPT	27.6 x 14.5 x 22.6" 70.2 x 36.8 x 57.5 cm	95°	35°	R134a	240/50/1/12.2	199	90.0	6150T21A130E
1/4	•	Positive Displacement	83	5.72	0.95	3.6	1/2" (F) NPT	27.6 x 14.5 x 22.6" 70.2 x 36.8 x 57.5 cm	95°	35°	R134a	240/50/1/6.8	141	64.0	6250P21A130E
1/3	•	Positive Displacement	83	5.72	0.95	3.6	1/2" (F) NPT	27.6 x 14.5 x 22.6" 70.2 x 36.8 x 57.5 cm	95°	35°	R134a	240/50/1/7.3	153	69.0	6350P21A130E
1/2	•	Positive Displacement	83	5.72	0.95	3.6	1/2" (F) NPT	27.6 x 14.5 x 22.6" 70.2 x 36.8 x 57.5 cm	95°	35°	R134a	240/50/1/8.9	178	81.0	6550P21A130E
3/4	•	Positive Displacement	83	5.72	2.9	11	1/2" (F) NPT	27.6 x 14.5 x 22.6" 70.2 x 36.8 x 57.5 cm	95°	35°	R134a	240/50/1/11.9	197	89.0	6750P41A130E
1	•	Positive Displacement	83	5.72	2.9	11	1/2" (F) NPT	27.6 x 14.5 x 22.6" 70.2 x 36.8 x 57.5 cm	95°	35°	R134a	240/50/1/12.2	199	90.0	6150P41A130E
1/4	•	Centrifugal	9.5	0.66	3.9	14.7	1/2" (F) NPT	27.6 x 14.5 x 22.6" 70.2 x 36.8 x 57.5 cm	95°	35°	R134a	240/50/1/5.6	131	59.4	6250M21A130E
1/3	•	Centrifugal	9.5	0.66	3.9	14.7	1/2" (F) NPT	27.6 x 14.5 x 22.6" 70.2 x 36.8 x 57.5 cm	95°	35°	R134a	240/50/1/5.9	143	64.8	6350M21A130E
1/2	•	Centrifugal	9.5	0.66	3.9	14.7	1/2" (F) NPT	27.6 x 14.5 x 22.6" 70.2 x 36.8 x 57.5 cm	95°	35°	R134a	240/50/1/7.2	168	76.2	6550M21A130E
3/4	•	Centrifugal	9.5	0.66	3.9	14.7	1/2" (F) NPT	27.6 x 14.5 x 22.6" 70.2 x 36.8 x 57.5 cm	95°	35°	R134a	240/50/1/9.2	187	85.0	6750M21A130E
1	•	Centrifugal	9.5	0.66	3.9	14.7	1/2" (F) NPT	27.6 x 14.5 x 22.6" 70.2 x 36.8 x 57.5 cm	95°	35°	R134a	240/50/1/9.5	189	85.7	6150M21A130E
1.5	•	Positive Displacement	83	5.72	2.9	11	1/2" (F) NPT	30.5 x 19 x 26" 78 x 48 x 66 cm	95°	35°	R134a	380/50/3/5.8	340	154.0	6850 (380V/3PH)
1.5	•	Positive Displacement	83	5.72	2.9	11	1/2" (F) NPT	30.5 x 19 x 26" 78 x 48 x 66 cm	95°	35°	R134a	220/50/3/11.5	340	154.0	6850 (220V/3PH)
1.5	•	Positive Displacement	83	5.72	2.9	11	1/2" (F) NPT	30.5 x 19 x 26" 78 x 48 x 66 cm	95°	35°	R134a	240/50/1/13	340	154.0	6850P46A270E
1.5	•	Positive Displacement	83	5.72	2.9	11	1/2" (F) NPT	30.5 x 19 x 26" 78 x 48 x 66 cm	95°	35°	R134a	240/50/1/13	340	154.0	6950P46A270E
2	•	Centrifugal	17.1	1.20	10	37.6	3/4" (F) NPT	30.5 x 37 x 42" 78 x 94 x 107 cm	95°	35°	R134a	380/50/3/8.5	520	236.0	DCA200 (380V/3PH)
2	•	Centrifugal	17.1	1.20	10	37.6	3/4" (F) NPT	30.5 x 37 x 42" 78 x 94 x 107 cm	95°	35°	R134a	220/50/3/14	520	236.0	DCA200 (220V/3PH)
3	•	Centrifugal	17.1	1.20	10	37.6	3/4" (F) NPT	30.5 x 37 x 42" 78 x 94 x 107 cm	95°	35°	R134a	380/50/3/13.3	570	259.0	DCA300 (380V/3PH)
3	•	Centrifugal	17.1	1.20	10	37.6	3/4" (F) NPT	30.5 x 37 x 42" 78 x 94 x 107 cm	95°	35°	R134a	220/50/3/26	570	259.0	DCA300 (220V/3PH)
3	•	Centrifugal	17.1	1.20	10	37.6	3/4" (F) NPT	30.5 x 37 x 42" 78 x 94 x 107 cm	95°	35°	R134a	220/50/3/29	570	259.0	DCW300 (220V/3PH)
5		Centrifugal	33	2.28	42	158	1.5" (F) NPT	56 x 34.5 x 67" 142.2 x 88 x 170.2 cm	104°	40°	R410a	380/50/3/15	990	449.0	DA500 (380V/3PH)
5		Centrifugal	33	2.28	42	158	1.5" (F) NPT	56 x 34.5 x 67" 142.2 x 88 x 170.2 cm	104°	40°	R410a	220/50/3/30	990	449.0	DA500 (220V/3PH)
7.5		Centrifugal	33	2.28	42	158	1.5" (F) NPT	56 x 34.5 x 67" 142.2 x 88 x 170.2 cm	104°	40°	R410a	380/50/3/20	1,080	490.0	DA750 (380V/3PH)
10		Centrifugal	46	3.17	53	200	1.5" (F) NPT	77 x 34.5 x 68.2" 195.6 x 88 x 173.2 cm	104°	40°	R410a	380/50/3/30	1,525	692.0	DA1000 (380V/3PH)

# Customer Service and Support

At PolyScience, your satisfaction is our top priority. We work closely with you to understand your business and your needs. We strive to provide you with product quality and performance that surpass your specifications – plus service and support that exceed your expectations.



## Application Assistance

Need assistance in selecting the best product for your application? We're eager to help! Our trained staff will walk you through all your options and alternatives to make certain that you get the product with the performance and features you need to make your work easier – and perhaps even a little more fun!



## On-Line Resources

You'll find a wealth of information and resources about PolyScience products that you can access anytime at [www.polyscience.com](http://www.polyscience.com).



## PolyScience Warranty

We back most of our products with a 2-year limited warranty on parts and labor. If for any reason you are unhappy with your product, please contact our Sales and Customer Service Department.



## Global Technical Support

Our certified, factory-trained technicians know your product inside and out and are experts in troubleshooting and repairing PolyScience equipment. To assure you of prompt, competent service regardless of where you're located, authorized PolyScience service and technical support are available directly from our factory or through a global network of approved providers.

PolyScience® is a registered trademark of Preston Industries, Inc.  
Cool Command™, DuraTop™, LidDock™, Swivel 180™, and WhisperCool™ are trademarks of PolyScience, Division of Preston Industries.

iPhone® is a registered trademark of Apple Inc.  
LabVIEW™ is a trademark of National Instruments Corporation  
Teflon® is a registered trademark of E. I. du Pont de Nemours and Company  
Viton® is a registered trademark of DuPont Performance Elastomers.  
Defined Substrate Technology® is a registered trademark of IDEXX Laboratories.  
DeviceNet™, Modbus®, and Profibus® are trademarks of their respective trademark holders.



## World-Class Quality

An ISO 9001 certified company, PolyScience has implemented the systems, processes, and procedures necessary to ensure the quality, performance, and reliability of every product or component we manufacture. We're continually raising our already high standards and constantly striving for improvement. To that end, we've deployed just-in-time production and other Lean Manufacturing techniques – such as self-managed teams, Kanban, Five “S,” Quick Changeover and Poke Yoke – throughout our vertically-integrated operation to help ensure that every step of the manufacturing process meets our rigid standards as well as ISO 9001 quality requirements

## IQ/OQ/PQ

To help your company assess, develop and implement regulatory compliance at the level you need, we can provide IQ/OQ/PQ (Installation, Operation and Performance Qualifications) for all our Circulators, Chillers, and General Purpose Water Baths.

## Calibration Certification

Our technicians can calibrate your PolyScience product to the highest NIST standards and issue a calibration certificate for your records. Depending on the product, 1 to 10 point calibrations can be provided.

6600 West Touhy Avenue  
Niles, IL 60714-4516 USA  
Phone: +1-847-647-0611  
(800) 229-7569  
Email: Sales@polyscience.com  
Fax: +1-847-647-1155  
www.polyscience.com



## Equipment Recycling

Taking care of the environment is a responsibility we all share. As part of our contribution to a greener world, we will gladly accept your old circulators, chillers, and water baths – regardless of brand – for disposal in an environmentally conscious manner. All recoverable materials such as steel, copper, plastic, and packaging will be recycled and refrigerants reclaimed by our qualified technicians.

## Equipment Trade-In

Are you in the market for a new Circulator, Chiller, Water Bath or other constant temperature control product? You can save money by trading in an old or broken device toward the purchase of a new PolyScience product. We will accept any brand and give you a discount toward your purchase. Naturally, we'll dispose of your old equipment in an environmentally conscious manner.



6600 West Touhy Avenue  
Niles, IL 60714-4516 USA

Phone: +1-847-647-0611  
(800) 229-7569

Email: [Sales@polyscience.com](mailto:Sales@polyscience.com)

Fax: +1-847-647-1155

[www.polyscience.com](http://www.polyscience.com)